



EVALUATING THE IMPACT OF NATURE-BASED SOLUTIONS

A Handbook for Practitioners

Independent
Expert
Report



Green space management



Knowledge building for sustainable urban transformation



Place regeneration



Health and well-being



Participatory planning and governance



Climate resilience



Biodiversity enhancement



Water management



New economic opportunities and green jobs



Natural and climate hazards



Air quality



Social justice and social cohesion

Research and
Innovation

Evaluating the Impact of Nature-based Solutions: A Handbook for Practitioners

European Commission
Directorate-General for Research and Innovation
Directorate C — Healthy Planet
Unit C3 — Climate and Planetary Boundaries

Contact Laura.PALOMO-RIOS@ec.europa.eu
Sofie.VANDEWOESTIJNE@ec.europa.eu
Email RTD-ENV-NATURE-BASED-SOLUTIONS@ec.europa.eu
RTD-PUBLICATIONS@ec.europa.eu

European Commission
B-1049 Brussels

Manuscript completed in March 2021.
First edition.

This document has been prepared for the European Commission, however it reflects the views only of the authors, and the European Commission is not liable for any consequence stemming from the reuse of this publication.

More information on the European Union is available on the internet (<http://europa.eu>).

PDF	ISBN 978-92-76-22821-9	doi:10.2777/244577	KI-04-20-586-EN-N
-----	------------------------	--------------------	-------------------

Luxembourg: Publications Office of the European Union, 2021

© European Union, 2021



The reuse policy of European Commission documents is implemented based on Commission Decision 2011/833/EU of 12 December 2011 on the reuse of Commission documents (OJ L 330, 14.12.2011, p. 39). Except otherwise noted, the reuse of this document is authorised under a Creative Commons Attribution 4.0 International (CC-BY 4.0) licence (<https://creativecommons.org/licenses/by/4.0/>). This means that reuse is allowed provided appropriate credit is given and any changes are indicated. For any use or reproduction of elements that are not owned by the European Union, permission may need to be sought directly from the respective rightholders.

Image credits:

cover: © MicroOne # 305386384, 2019. Source: stock.adobe.com

EUROPEAN COMMISSION

EVALUATING THE IMPACT OF
NATURE-BASED
SOLUTIONS

A Handbook for Practitioners

Adina Dumitru and Laura Wendling, Eds.

Table of Contents

FOREWORD	6
LIST OF ABBREVIATIONS	10
1. INTRODUCTION	16
1.1 What are Nature-based Solutions?	17
1.2 NBS in European and International policy frameworks	20
1.2.1 NBS in the European policy context	20
1.2.2 NBS in an International policy context.....	23
1.3 Purpose of the NBS Impact Evaluation Handbook.....	25
1.3.1 Handbook aim	25
1.3.2 Intended audience of this handbook.....	26
1.3.3 How this handbook was developed.....	27
1.4 Content of this handbook	34
1.5 Conclusions.....	37
1.6 References	38
<i>PROFILE: NATURE4CITIES</i>	40
<i>PROFILE: NATURVATION</i>	42
<i>PROFILE: THINK NATURE</i>	44
2. PRINCIPLES GUIDING NBS PERFORMANCE AND IMPACT EVALUATION .	46
2.1 Introduction and definitions.....	47
2.1.1 The concept of effectiveness	51
2.2 Decision-making context and impact evaluations: from needs to indicators .	53
2.3 Principles for the development of impact monitoring and evaluation plans...	57
2.3.1 Steps	57
2.3.2 Principles.....	58
2.4 Capitalising on existing experiences and remaining critical concerns.....	64
2.4.1 Challenges and gaps in current monitoring and evaluation efforts.....	64
2.4.2 Key messages from existing projects	67
2.5 References	68
<i>PROFILE: CONNECTING NATURE</i>	70
<i>PROFILE: GROW GREEN</i>	72
<i>PROFILE: UNALAB</i>	74
<i>PROFILE: URBAN GREENUP</i>	76
3. APPROACHES TO MONITORING AND EVALUATION STRATEGY DEVELOPMENT	78
3.1 Introduction: developing robust impact assessment plans.....	79

3.2 A step by step approach to developing robust monitoring and evaluation plans for NBS	80
3.3 Robust assessment and co-production: a necessary relationship	90
3.4 Innovative tools for monitoring and evaluation of nature-based solutions....	96
3.4.1 Reflexive monitoring – Connecting Nature project.....	96
3.4.2 iAPT (Impact Assessment Planning Tool) – Connecting Nature project..	99
3.4.3 Urban GreenUP Tool – Urban GreenUP project.....	100
3.5 Conclusions.....	102
3.6 References	103
<i>PROFILE: CLEVER CITIES</i>	<i>106</i>
<i>PROFILE: PROGIREG</i>	<i>108</i>
<i>PROFILE: EDICITNET.....</i>	<i>110</i>
<i>PROFILE: URBINAT</i>	<i>112</i>
4. INDICATORS OF NBS PERFORMANCE AND IMPACT	114
4.1 Societal challenge areas addressed by NBS	116
4.2 Recommended and Additional indicators for NBS impact assessment.....	120
4.2.1 Climate Resilience	124
4.2.2 Water Management	128
4.2.3 Natural and Climate Hazards.....	132
4.2.4 Green Space Management	137
4.2.5 Biodiversity Enhancement.....	142
4.2.6 Air Quality	145
4.2.7 Place Regeneration	148
4.2.8 Knowledge and Social Capacity Building for Sustainable Urban Transformation	151
4.2.9 Participatory Planning and Governance.....	153
4.2.10 Social Justice and Social Cohesion	156
4.2.11 Health and Wellbeing	158
4.2.12 New Economic Opportunities and Green Jobs	163
4.3 Conclusions.....	168
4.3.1 Summary of the indicator framework presented	168
4.3.2 Emerging concerns and further development needs	168
4.4 References	169
<i>PROFILE: CLEARING HOUSE.....</i>	<i>173</i>
<i>PROFILE: REGREEN.....</i>	<i>175</i>
5. APPLICATION OF THE NBS IMPACT EVALUATION FRAMEWORK: NBS PERFORMANCE AND IMPACT EVALUATION CASE STUDIES	177
5.1 Introduction to holistic NBS impact assessment using the framework of recommended indicators	179
5.1.1 Recommended indicators case study from Tampere, Finland	181

5.1.2 Recommended indicators case study from Valladolid, Spain	183
5.1.3 Recommended indicators case study from Guildford, UK.....	186
5.1.4 Recommended indicators case study from Genk, Belgium.....	189
5.2 Case studies illustrating the 'story of an indicator' for some of the additional indicators	196
5.2.1 Climate Resilience – Urban heat Island incidence.....	196
5.2.2 Natural and climate hazards – Flood risk	199
5.2.3 Green space management – Walkability	203
5.2.4 Green space management – Annual trend in vegetation cover.....	205
5.2.5 Green space management – ESTIMAP nature-based recreation	211
5.2.6 Green space management – Land composition	215
5.2.7 Biodiversity Enhancement – Number of conservation priority species ..	219
5.2.8 Air Quality – Trends in NOx and SOx emissions	221
5.2.9 Knowledge and Social Capacity Building for Sustainable Urban Transformation – Connectedness to nature	223
5.2.10 Social Justice and Social Cohesion – Perceived social support.....	224
5.2.11 Health and Wellbeing – Prevalence, incidence, and morbidity of chronic stress.....	226
5.2.12 Health and Wellbeing – Perceived chronic loneliness.....	229
5.3 Conclusions.....	232
<i>PROFILE: NAIAD</i>	233
<i>PROFILE: OPERANDUM</i>	235
<i>PROFILE: PHUSICOS</i>	237
<i>PROFILE: RECONNECT</i>	239
6. NBS FOR DISASTER RISK REDUCTION	241
6.1 NBS and Disaster Risk Reduction	242
6.2 Basics of risk analysis, risk reduction measures, resilience and effectiveness	243
6.3 Indicators and methodologies for measuring NBS effectiveness indicators in DRR context	248
6.4 Case study #1 – from indicators assessment to integration and decision-aiding for flood risk management.....	254
6.4.1 Context and global framework for assessment of NBS effectiveness....	254
6.4.2 Indicators for assessment of technical, physical and economic efficacy of flood mitigation strategies including NBS	255
6.5 Case study #2 – a green barrier to reduce the risk of floods due to snowmelt and extreme rainfall	258
6.5.1 General background and hazard type	258
6.5.2 Co-benefits of the proposed NBS	259
6.5.3 Indicators for the NBS performance assessment.....	260
6.6 Case study #3 – landslides and debris flows.....	264
6.7 Case study #4 – floods in dense urban environments.....	268

6.8 Concluding remarks	270
6.9 References	270
<i>PROFILE: MAES</i>	273
<i>PROFILE: ENROUTE</i>	275
7. DATA REQUIREMENTS.....	277
7.1 Data terminology, definitions and key concepts	279
7.1.1 Spatial versus non-spatial data	279
7.1.2 Baseline data	280
7.1.3 Control data.....	280
7.1.4 Acquisition regime	281
7.1.5 Spatial scale of analysis.....	282
7.1.6 Processing level.....	283
7.1.7 Data generation and collection methods	284
7.2 Environmental data of relevance for NBS monitoring and assessment.....	287
7.2.1 Remote sensing (RS) and Earth Observation (EO)	288
7.2.2 In-situ observations and ground measurements	296
7.2.3 Surveys.....	300
7.3 Socio-economic, demographic and behavioural datasets for NBS monitoring and assessment: Methods and sources.....	301
7.3.1 Quantitative, qualitative and map-based surveys.....	303
7.3.2 Population observations.....	306
7.4 Data sources for the assessment of changes to health and wellbeing.....	307
7.5 Predicting the present and future impacts of NBS with modelling techniques	311
7.6 Mimicking the impacts of NBS: how laboratory data can help	326
7.7 Engaging the community in the data collection process: citizen science and its role in NBS monitoring	326
7.8 Data integration	329
7.9 Baseline assessment	339
7.10 Data adequacy and related aspects	344
7.10.1 Data gaps and irregularities	348
7.10.2 Data granularity and resolution	349
7.10.3 Data accuracy	351
7.10.4 Biases, main error sources, and data reliability	353
7.10.5 Data accessibility	353
7.10.6 Metadata and data standardization	355
7.11 Conclusion.....	357
7.12 References	361

FOREWORD

Urban expansion and densification brings both opportunities and challenges. Regeneration of urban areas is therefore a significant priority, which needs to take into account environmental quality, social justice and sustainable development. Transforming cities and regions into vibrant, sustainable and resilient living places has become a key global priority. This is reflected in numerous policy initiatives at local, regional and national scale, and internationally through the UN Sustainable Development Goals (particularly SDG 11). Together these are part of a global call to rethink and redesign urban environments through innovative solutions that address multiple issues.

The EU Research and Innovation policy agenda on Nature-based Solutions and Re-naturing Cities defines nature-based solutions to societal challenges as *“solutions that are inspired and supported by nature, which are cost-effective, simultaneously provide environmental, social and economic benefits and help build resilience. Such solutions bring more, and more diverse, nature and natural features and processes into cities, landscapes and seascapes, through locally adapted, resource-efficient and systemic interventions”*¹. Nature-based solutions (NBS) intrinsically provide biodiversity benefits and support the delivery of ecosystem services; however, there is increasing recognition of the multitude of environmental, social and economic co-benefits delivered by NBS.

The objective of this handbook is to support the adoption of common indicators and methods for assessing the performance and impact of diverse types of NBS. The handbook is designed to be relevant for NBS implemented across a wide geographic area and at a multitude of scales. The integrated NBS assessment framework presented in the handbook has been developed with the three-fold objective of:

- Serving as a reference for relevant EU policies and activities;
- Orienting urban practitioners in developing robust impact evaluation frameworks for nature-based solutions at different scales; and,
- Providing a comprehensive set of indicators and methodologies.

This handbook is intended to serve as a guide to the development and implementation of scientifically-valid monitoring and evaluation plans for the evaluation of NBS impacts (Figure 1). We begin by defining NBS in the context of global challenges and key policy instruments (Chapter 1). Subsequent chapters guide the reader through the development and execution of robust NBS monitoring and evaluation plans (Chapter 2 and Chapter 3), the selection (Chapter 4 and Appendix of Methods) and application (Chapter 5) of impact indicators, the use of NBS in Disaster Risk Reduction (DRR; Chapter 6), and the acquisition and management of relevant data (Chapter 7).

¹ https://ec.europa.eu/info/research-and-innovation/research-area/environment/nature-based-solutions_en

Why do we need a coordinated approach to NBS impact monitoring? **Chapter 1** describes how the development of robust monitoring and evaluation frameworks to assess NBS impacts enables cities and regions to assess the strengths and weaknesses of specific interventions in achieving strategic goals, understand the realised benefits and trade-offs, and sustainably manage NBS in the long term. Chapter 1 also describes how monitoring and evaluation can help to build the case for investments in NBS.

How do monitoring and evaluation contribute to evidence-based policy-making and policy learning? Monitoring and evaluation tells us whether an NBS functions as desired by providing evidence of its ability to achieve specific outcomes. **Chapter 2** describes the principles that guide NBS performance and impact evaluation to support the development of an appropriate, scientifically robust NBS monitoring and evaluation plan. The chapter presents general steps along with advice on how these steps can be tailored to suit a specific NBS context.

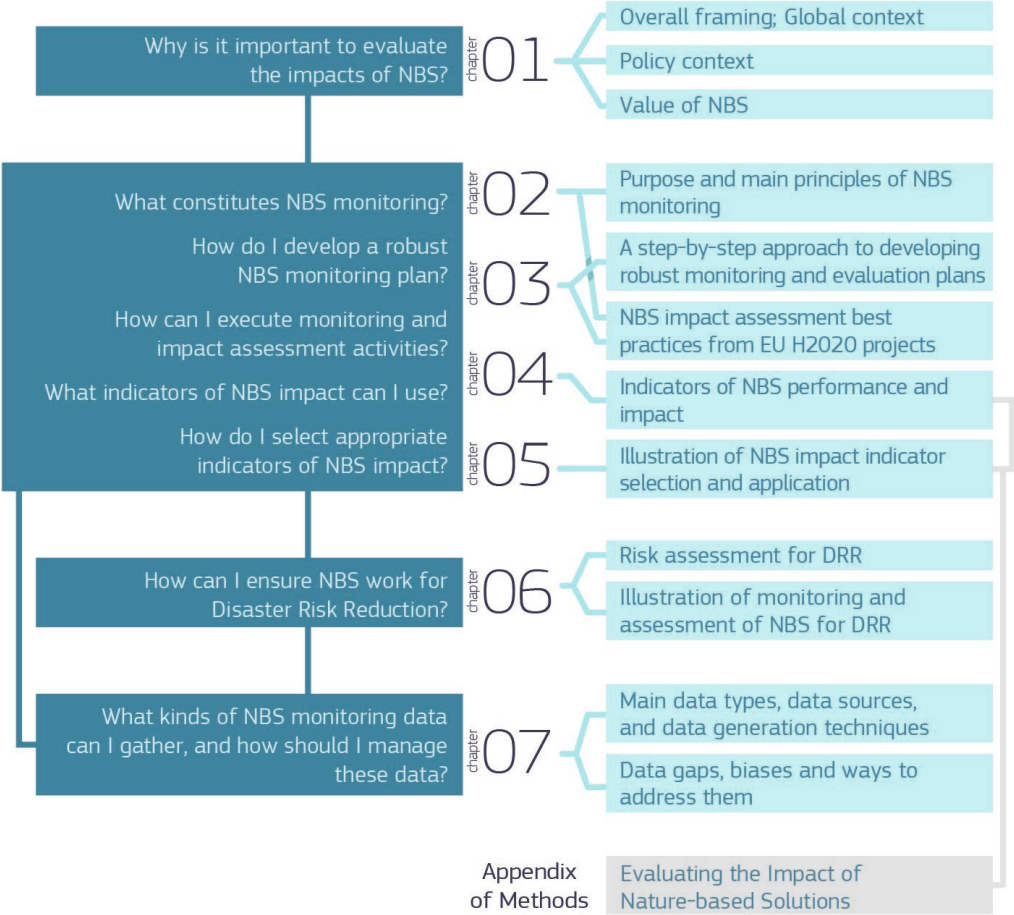

Figure1. Overall structure and content of this handbook.

Chapter 3 further elaborates the steps in the development of monitoring and evaluation plans. The development of local NBS monitoring and evaluation strategies are illustrated by a series of case studies from several EU H2020 projects. In particular, Chapter 3 emphasises the connection between NBS evaluation and monitoring plans and the processes of knowledge co-production and NBS co-management.

How is impact measured? The impacts of NBS can be assessed quantitatively and/or qualitatively by adopting indicators, a set of variables providing the means to assess particular attributes to meet an explicit objective. Identification and selection of specific indicators to evaluate NBS can seem a daunting prospect due to the vast selection of potential indicators and their specific metrics. The buffet-style overview of indicators in this handbook helps the reader select the appropriate indicators. The handbook builds upon and expands the EKLIPSE Expert Working Group Impact evaluation framework. **Chapter 4** presents a suite of Recommended and Additional indicators to evaluate NBS impact across the following 12 societal challenge areas:

1. Climate Resilience
2. Water Management
3. Natural and Climate Hazards
4. Green Space Management
5. Biodiversity
6. Air Quality
7. Place Regeneration
8. Knowledge and Social Capacity Building for Sustainable Urban Transformation
9. Participatory Planning and Governance
10. Social Justice and Social Cohesion
11. Health and Well-being
12. New Economic Opportunities and Green Jobs

In addition to the identification and classification of NBS impact indicators across each of the 12 identified societal challenge areas, a range of methodological approaches are presented in the accompanying *Evaluating the Impact of Nature-based Solutions: Appendix of Methods*. The **Appendix of Methods** provides a brief description of each indicator determination method, along with guidance for end-users about the appropriateness, advantages and drawbacks of each method in different contexts.

How does it all fit together? **Chapter 5** presents a number of different case studies to further illustrate the selection and application of indicators for impact evaluation of different types of NBS implemented across a range of scales and in diverse environments. The examples display how indicators can be used together to address specific issues with the aim to inspire other cities and regions in developing robust monitoring and evaluation frameworks and facilitate evidence-based urban policy-making for NBS.

Chapter 6 details the use of NBS in ecosystem-based disaster risk reduction (Eco-DRR) schemes, outlining the components of risk and the potential impacts

of NBS on risks due to natural phenomena. The use of NBS for DRR is illustrated by a series of case studies focused on large-scale hydro-meteorological risk reduction.

Chapter 7 provides an overview of data types, sources and techniques for the generation of data to monitor and assess the impacts of NBS. An understanding of different types of data, their sources and use is core to the development of robust monitoring and evaluation plans.

The handbook supports practitioners to independently design and implement NBS impact evaluation schemes. The indicators and methods of NBS impact assessment presented reflect the state of the art in scientific research on impacts of nature-based solutions and are valid and standardised methods of assessment. The selection is not exhaustive, but acts as a European reference framework on NBS impact evaluation and monitoring. The handbook synthesises information concerning the current state of play in the implementation of evaluation frameworks, as fostered by the European agenda on climate change adaptation and disaster risk reduction, including the re-naturing of cities and urban transformation towards sustainable, liveable, healthy and just cities.

This handbook was collaboratively developed by the NBS Impact Evaluation Taskforce, a clustering initiative by the EU Commission to capitalise on synergies between H2020 funded projects relating to NBS. The handbook expands on the pioneering work of the EKLIPSE Working Group on Nature-based Solutions to Promote Climate Resilience in Urban Areas.

These Horizon2020 funded projects and collaborating institutions contributed to the NBS Impact Evaluation Taskforce that prepared this handbook (in alphabetical order): CLEARING HOUSE; CLEVER Cities; CONNECTING Nature; EdiCitNet; EEA; GROW GREEN; JRC; MAES/EnRoute; NAIAD; Nature4Cities; Naturvation; OPERANDUM; PHUSICOS; proGIreg; RECONNECT; REGREEN; Think Nature; UNaLab; URBAN GreenUP; and, URBiNAT. The taskforce has relied on the input of more than 150 European researchers and over 60 European cities and regions involved in these projects. We thank all authors, lead authors and coordinating lead authors for their hard work and commitment to developing the handbook, and the European Commission for their support throughout the development of this work.

We hope that this handbook is helpful to those who make the difference in the field - practitioners, planners and decision-makers who implement NBS. Let this handbook inspire your work.

*Rik De Vrees
Adina Dumitru
Sebastian Eiter
Laurence Jones
Laura Wendling
Marianne Zandersen*

LIST OF ABBREVIATIONS

ABM	Agent-based model
ADCIRC	Advanced circulation model
ADHD	Attention deficit hyperactivity disorder
ANK	Atlas of Natural Capital
API	Application programming interface
AQP	Air quality pollutant
ARIES	Artificial Intelligence for Ecosystem Services
ART	Attention Restoration Theory
AVHRR	Advanced very high-resolution radiometer
BEST	Benefits Estimation Tool
BC	Black carbon
BI	Blue infrastructure
BGI	Blue-green infrastructure
BISE	Biodiversity Information System for Europe
BMI	Body mass index
BMPs	Best management practices
bVOC	Biogenic volatile organic compound
CA	Cellular automata
CBA	Cost-benefit analysis
CCA	Climate change adaptation
CH ₄	Methane
CIF	Common Implementation Framework
CNS	Connectedness to nature scale
CO	Carbon monoxide
CO ₂	Carbon dioxide
CO ₂ e	Carbon dioxide equivalent
CORDEX	Coordinated Regional Climate Downscaling Experiment
CVD	Cardiovascular disease
DEM	Discrete element method
DRMKC	Disaster Risk Management Knowledge Centre
DRR	Disaster risk reduction
EbA	Ecosystem-based adaptation

Eco-DRR	Ecosystem-based disaster risk reduction
EC	European Commission
ECMWF	European Centre for Medium-Range Weather Forecasts
ECS	Edible City Solutions
ECV	Essential climate variable
EE	Ecological engineering
EEA	European Environment Agency
EO	Earth observation
ERA40	Re-analysis of meteorological data from September 1957 to August 2002 produced by ECMWF
ESA	European Space Agency
ESM	European Settlement Map
ESS	Ecosystem services
ESTIMAP	Ecosystem Services Mapping tool
EU	European Union
Eurostat	Statistical Office of the European Union
FAIR	Findability, accessibility, interoperability and reusability of data
FEV	Flood excess volume
FRAME	Fine Resolution Atmospheric Multi-species Exchange model
FRC	Front-runner city
FUA	Functional urban area
GCM	General circulation model
GDPR	General Data Protection Regulation
GEE	Google Earth engine
GHG	Greenhouse gas
GHSL	Global Human Settlement Layer
GI	Green infrastructure
GIS	Geographic Information System
GLEON	Global Lake Ecological Observatory Network
GVA	Gross value added
H2020	Horizon 2020 framework programme
HEC	Hydrologic Engineering Center
HEE	Hydrological extreme event

HFA	Hyogo Framework for Action
HMR	Hydro-meteorological risk
IACS	Integrated Agriculture and Control System
ICOS	Integrated Carbon Observation System
ILO	International Labour Organization
INSPIRE	Infrastructure for Spatial Information in Europe
InVEST	Integrated Valuation of Ecosystem Services and Tradeoffs
IPAQ	International physical activity questionnaire
IPCC	Intergovernmental Panel on Climate Change
ISO	International Organization for Standardization
IUCN	International Union for the Conservation of Nature
IVR	Immersive virtual reality
JRC	Joint Research Centre
KIP INCA	Integrated system of Natural Capital and Ecosystem Services accounting
KPI	Key performance indicator
LAI	Leaf area index
LID	Low-impact development
LiDAR	Light detection and ranging
LL	Living Lab
LM	Landscape mosaic
LUCI	Land Utilisation Capability Indicator
LUE	Land Use Efficiency
LUISA	Land Use-based Integrated Sustainability Assessment
LULC	Land use and land cover
LUT	Look-up tables
M&E	Monitoring and evaluation
MAES	Mapping and Assessment on Ecosystems and their Services
MCDA	Multicriteria decision analysis
MODIS	Moderate resolution imaging spectroradiometer
NBS	Nature-based solution
NC	Natural capital
NDVI	Normalised Difference Vegetation Index

NGO	Non-governmental organisation
NO ₂	Nitrogen dioxide
NO ₃ -N	Nitrate-nitrogen
NO _x	Nitrogen oxides
NUTS	Nomenclature of Territorial Units for Statistics
NWRM	Natural Water Retention Measures
O ₃	Ozone
OAL	Open Air Laboratory
OECD	Organisation for Economic Cooperation and Development
OGC	Open Geospatial Consortium
OS	Opportunity spectrum
OSGeo	Open Source Geospatial Foundation
OSM	Open Street Map
PAH	Polycyclic aromatic hydrocarbon
PLS	Partial least square
PM	Particulate matter
PM _{2.5}	Particulate matter <2.5 µm in diameter
PM ₁₀	Particulate matter <10 µm in diameter
PPGIS	Public participation geographic information system
PPP	Public-private partnership
ROI	Return on investment
RP	Recreation potential
ROS	Recreation Opportunity Spectrum
RS	Remote sensing
RUP	Re-naturing Urban Plan
SAR	Synthetic aperture radar
SCI	Site of community importance
SD	System dynamics
SDG	Sustainable Development Goal
SEA	Strategic environmental assessment
SEDAC	Socioeconomic Data and Applications Centre
SES	Social-ecological systems
SFDRR	Sendai Framework for Disaster Risk Reduction

SMART	Specific, Measurable, Attributable, Realistic, Targeted
SO ₂	Sulphur dioxide
SO _x	Sulphur oxides
SoIVES	Social Values for Ecosystem Services
SOPARC	System for Observing Play and Recreation in Communities
SPA	Special protection area
SRA	Strategic Research Agenda
SROI	Social return on investment
SRT	Stress Recovery Theory
SuDs	Sustainable urban drainage systems
SWAN	Simulative Waves Nearshore model
SWAT	Soil Water Assessment Tool
SWMM	Storm Water Management Model
TC	Technical Committee
TEEB	The Economics of Ecosystems and Biodiversity
TESSA	Toolkit for Ecosystem Service Site-based Assessment
TF	Taskforce
TOPHEE	Approach combining indicators for technical, physical, organizational, environmental, social/human and economic features
TSS	Total suspended solids
UCDB	Urban Centres Database
UCM	Urban canopy model
UCS	Urban Carbon Sink
UF	Urban forestry
UGI	Urban green infrastructure
UHI	Urban Heat Island
ULL	Urban Living Lab
UN	United Nations
UNA	Urban Nature Atlas
UNEP	United Nations Environment Programme
UNISDR	United Nations International Strategy for Disaster Reduction
UTCI	Universal Thermal Comfort Index

VGI	Volunteered geographic information
VOC	Volatile organic compound
WCDRR	World Conference on Disaster Risk Reduction
WEAP	Water Evaluation and Planning model
WHO	World Health Organisation
WMO	World Meteorological Organization
WSN	Wireless sensor network
WSUD	Water-sensitive urban design
WRF	Weather Research and Forecasting Model
YoLL	Years of life lost

01

Why is it important to evaluate the impacts of NBS?

Overall framing;
Global context

Policy context

Value of NBS

What constitutes NBS monitoring?

How do I develop a robust NBS monitoring plan?

How can I execute monitoring and impact assessment activities?

What indicators of NBS impact can I use?

How do I select appropriate indicators of NBS impact?

How can I ensure NBS work for Disaster Risk Reduction?

What kinds of NBS monitoring data can I gather, and how should I manage these data?

1 INTRODUCTION

Coordinating Lead author

Sgrigna, G.

Lead authors

Sgrigna, G., López-Gunn, E., Dubovik, M.

Contributing authors

Di Sabatino, S., Kumar, P., Feliu, E., Ruangpan, L., San Jose, E., Sanchez, R., Van Cauwenbergh, N., Vojinovic, Z., Wendling, L.

Summary

What is this chapter about?

This chapter introduces the aim of the *NBS Impact Evaluation Handbook* as a reference for evaluating the impacts of nature-based solutions (NBS). It provides a general framework on the value of NBS to the community, investors, and policy makers, and illustrates how the NBS impact evaluation framework can be used. Chapter 1 describes the global context in which NBS operate. Two infographics help visualise the definition of NBS and provide an in-depth explanation of the concept's origin and evolution. Another infographic describes the full life cycle of NBS including monitoring, evaluation, and cost-benefit analysis. The chapter concludes by describing the content of each section of the handbook.

Chapter 1 illustrates how an impact evaluation framework supports:

- 1) Policy evaluation and the achievement of policy and regulatory goals;
- 2) Social accountability, so that citizens' concerns are taken into account; and,
- 3) Investment in NBS, including the comparison of NBS impacts with those of other technical engineered approaches.

How can I use this chapter in my work with NBS?

Chapter 1 provides fundamental background information on the concept of NBS, its adoption and the benefits of assessing NBS design, uptake, and implementation.

When can I use this knowledge in my work with NBS?

It is particularly useful during the early stages, to understand the framing, when you start planning NBS implementation and the monitoring and evaluation framework.

How does this chapter link with the other parts of the handbook?

This chapter frames the content of the *NBS Impact Evaluation Handbook* and provides an overall guide to its different sections.

1.1 What are Nature-based Solutions?

The concept of *nature-based solutions* embodies new ways to approach socio-ecological adaptation and resilience, with equal reliance upon social, environmental and economic domains. Nature-based solutions (NBS) were clearly described for the first time in the final report of the Horizon 2020 Expert Group (EC, 2015). The European Commission defines NBS as solutions that are "inspired and supported by nature, which are cost-effective, simultaneously provide environmental, social and economic benefits and help build resilience. Such solutions bring more, and more diverse, nature and natural features and processes into cities, landscapes and seascapes, through locally adapted, resource-efficient and systemic interventions."² Inherent in this definition is the idea that NBS must benefit biodiversity and support the delivery of a range of ecosystem services. Similarly, the International Union for Conservation of Nature (IUCN) defines NBS as "actions to protect, sustainably manage, and restore natural or modified ecosystems, that address societal challenges effectively and adaptively, simultaneously providing human well-being and biodiversity benefits"³.

² https://ec.europa.eu/info/research-and-innovation/research-area/environment/nature-based-solutions_en

³ <https://www.iucn.org/commissions/commission-ecosystem-management/our-work/nature-based-solutions>

The NBS concept, as reported by Escobedo et al. (2019), is the evolution of terms used previously to express similar ideas: urban forestry (UF); green and blue infrastructure (GI, BI); and ecosystem services (ESS). Eisenberg et al. (2018) and Ruangpan et al. (2020) identify additional concepts and practices that can be broadly placed under the umbrella of NBS: ecosystem-based adaptation (EbA), ecosystem-based disaster risk reduction (Eco-DRR), blue-green infrastructure (BGI), low-impact development (LID), best management practices (BMPs), water-sensitive urban design (WSUD), sustainable urban drainage systems (SuDs), and ecological engineering (EE). With respect to NBS, these existing concepts are applicable across strategic, spatial planning, soft engineering, and performance dimensions (Figure 1-1).

Experts with different backgrounds view NBS through various disciplinary lenses. Dorst et al. (2019) describe NBS as “interventions based on nature that are envisaged to address sustainability challenges such as resource shortages, flood and heat risks and ecosystem degradation caused by processes of urbanization and climate change”. Kabisch et al. (2016) underline the connection of NBS with “the maintenance, enhancement, and restoration of biodiversity and ecosystems as a means to address multiple concerns simultaneously”. In contrast, Frantzeskaki et al. (2017) view NBS in a social-ecological context, noting that “transition initiatives as actor configurations that establish, experiment and localise nature-based solutions shift them from ‘solutions’ to social configurations, making nature-based solutions the new ‘urban commons of sustainability’...”. A recent editorial about NBS within the *Nature* journal stated that “the concept it represents is of vital and urgent significance. As the grand challenges that face society continue to build, so does the need for multidisciplinary, evidence-based strategies to, for example, protect water supplies, address habitat loss and mitigate and adapt to climate change” (‘Natural language: the latest attempt to brand green practices is better than it sounds’, 2017). In short, NBS provide integrated, multifunctional solutions to many of our current urban and rural challenges through the use of nature and natural processes.

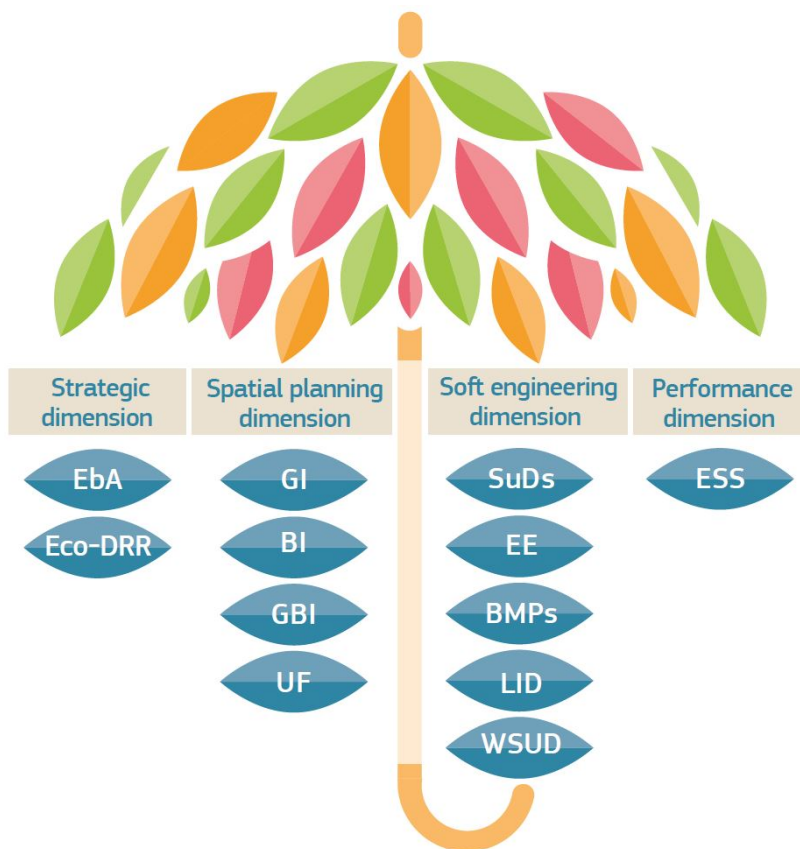

Figure 1-1. Nature-based solutions as an umbrella concept and the relation of NBS to key existing concepts. EbA = ecosystem based adaptation; Eco-DRR = ecosystem-based disaster risk reduction; GI = green infrastructure; BI = blue infrastructure; GBI = green-blue infrastructure; UF = urban forestry; SuDs = sustainable urban drainage systems; EE = ecological engineering; BMPs = best management practices; LID = low-impact design; WSUD = water-sensitive urban design; ESS = ecosystem services.

The application of NBS is the deliberate inclusion of natural system processes within human environments to obtain relevant outcomes in the form of ecosystem services. For example, a well-managed forest can provide multiple ESS, including provisioning, regulating and cultural ecosystem services. Provisioning services provided by a forest may include timber, fuel, fibre, and/or food. Climate regulation is one example of a regulating service provided by forests due to evapotranspiration and shading of land surfaces (cooling), and the removal and fixation of atmospheric CO₂ within tree biomass. The leaves and roots of trees can also intercept and lessen rainfall runoff and reduce the impact of flooding (flood regulation), creating a natural buffer. The cultural services provided by natural areas are increasingly recognised, including benefits such as enhanced mental well-being, increased recreational value, educational opportunities, new job niches in nature-based enterprises or less tangible aesthetic and spiritual benefits.

NBS are characterised by their capacity to simultaneously address several societal challenges in terms of primary benefits and co-benefits, or ecosystem services. Among other positive impacts, such as enhanced resilience to the impacts of climate change or increased biodiversity, one of the common denominators of NBS is the concept of sustainability. The implementation of NBS in human environments could be considered as a fundamental tool capable of sustaining human life and activities over time in a way that is compatible with the planetary boundaries (Rockström et al., 2009); a “green – blue pedal” in the hands of policy makers, administrators and practitioners. In other words, NBS provide opportunity to enhance and maintain the liveability of human settlements for current and future generations.

The development of new urban environments based on sustainability are undermined by the standard models of urbanisation processes (Lafortezza and Sanesi 2019). There is growing evidence regarding the benefits of NBS for DRR and CCA, particularly if these are carefully planned and managed, and interconnected in a network of solutions (Debele et al., 2019; Kabisch et al., 2016; Sahani et al., 2019). A nature-based approach to urban and peri-urban development and management has been growing in popularity over the last decade, but still needs to be fully integrated into national, regional, and local policies. In particular, there is interest within the (re)insurance industry in understanding the protective role of NBS in buffering risks posed by natural hazards (Marchal et al., 2019).

Remaining knowledge gaps and a lack of comprehensive evidence on the reversibility, flexibility, cost-effectiveness and feasibility, and/or long-term sustainability of NBS as compared with grey approaches are barriers to mainstreaming of NBS and their full incorporation within (re)insurance schemes (Ruangpan et. al., 2020). This may deter decision-makers from investing in the design and implementation of NBS for DRR and CCA rather than solely relying on conventional grey solutions. Thus, additional NBS performance and impact data, specifically evidence from field studies, is required to facilitate the integration of these emerging concepts and NBS strategies in urban and regional planning and design. The generation and dissemination of monitoring and evaluation data will promote further NBS actions, creating a positive cycle for the generation of an increasingly detailed knowledge base on NBS efficiency and cost-effectiveness and informing the further development of policies regarding land management and urban development (Kabisch et al., 2016).

1.2 NBS in European and International policy frameworks

1.2.1 NBS in the European policy context

To adapt to and mitigate the negative impacts of climate change and urbanisation and to effectively address these challenges, decision-makers at local, regional and global levels have gradually shifted paradigms away from a hard engineering to a more adaptive and softer approach that enlarges the portfolio of options to include NBS, including eco-engineering and ecological restoration. Since 2015, within this new paradigm, NBS have been advocated by both policymakers and

practitioners as resilient, adaptable, resource efficient, locally adjustable, mainly equitable, and optimised options to maximize opportunities to improve the well-being of all urban residents, independent of their socioeconomic status, gender, cultural background, or age (Favre et al., 2017).

Nature-based solutions present a credible means to address key societal issues, such as climate change, disaster risk, and biodiversity loss (SEP, 2021). A multitude of scientific studies have demonstrated that NBS can contribute to substantial improvements in air quality, microclimate conditions, and the health and well-being of citizens. As such, NBS are highlighted in the European Green Deal and recent key European policy initiatives, such as the EU Biodiversity Strategy for 2030 (EC, 2020) and the new EU Strategy on Adaptation to Climate Change (EC, 2021). In particular, the EU Biodiversity Strategy for 2030 highlights the value and importance of NBS in fighting biodiversity loss, climate change and other critical challenges, and promises funding for investment in NBS. Nature-based solutions are also likely to play a key role in the new EU Forest Strategy (currently under public consultation), and the forthcoming EU Soil Strategy and European Zero Pollution Action Plan for air, water and soil.

The role of NBS as natural, functional infrastructure that can contribute to sustainability, improve environmental quality and citizens' well-being, whilst simultaneously providing opportunities for economic development is consistent with the EU Adaptation Strategy to climate change published in 2013⁴ that aimed to address climate adaptation in the European Union (EC, 2013). The strategy specifically focused on enhancing the preparedness and capacity to respond to the impacts of climate change at local, regional, national and EU levels, developing a coherent approach and improving coordination (EC, 2013). The updated EU Strategy on Adaptation to Climate Change issued in February 2021⁵ specifically highlights NBS as a cross-cutting priority area to support the further development and implementation of climate adaptation strategies at all levels of governance (EC, 2021). The EC has also expressed support for the 'NbS for Climate Manifesto', proposed in August 2019 at the UN Climate Action Summit 2019.

NBS implementation can enhance the implementation of other major European policies and strategies. Targeted NBS interventions are capable of enabling a more comprehensive implementation of the Floods Directive⁶ via complementing national flood management strategies and flood risk management plans, e.g. through natural flood management schemes; Groundwater Directive⁷ via interventions that reduce the burden on groundwater resources; and the Urban Waste-Water Treatment Directive⁸ via infiltrating a portion of surface runoff. The overarching Water Framework Directive⁹ enforces the implementation of the local river basin management plans to which NBS contribute directly and indirectly. Nature-based solutions contribute directly to the Water Framework Directive (WFD) through integrated water management in terms of quality and quantity,

⁴ COM(2013) 216 final

⁵ COM/2021/82 final

⁶ OJ L 288, 6.11.2007, p. 27–34

⁷ OJ L 372, 27.12.2006, p. 19–31

⁸ OJ L 135, 30.5.1991, p. 40–52

⁹ OJ L 327, 22.12.2000, p. 1–73

which supports compliance with requirements for good ecological, physicochemical, and other statuses of surface waters and groundwater set by the WFD, as well as the active participation of stakeholders through co-design of NBS measures for water security.

NBS for DRR strategies additionally contribute to the Marine Strategy Framework Directive¹⁰ via environmental targets and monitoring of coastal zones, the new emphasis on the Blue economy, and indirectly to the EU Civil Protection Mechanism by joint planning and coordination of disaster response activities for enhanced prevention and preparedness to disasters. NBS employed for DRR equally contribute to the Floods Directive by lessening the potential consequences and magnitude of flooding at flood risk zones previously identified during the preliminary flood risk assessment. The EU Action Plan on the Sendai Framework for Disaster Risk Reduction (2015) builds on the Sendai Framework and the associated international agreements and processes, to further enhance and promote disaster risk management and its integration in EU policies. The EU Action Plan on the Sendai Framework for Disaster Risk Reduction presents ways that risks can be reduced through working with nature, while also providing human, biodiversity and climate benefits¹¹.

Biodiversity emphasis, as the core of the NBS concept (cf. Section 1.1), observes distinct ties with Natura2000 network, and the Birds¹²- and Habitats¹³ Directives by directly re-establishing natural habitats and their connectivity, in compliance with the EU goals on green infrastructure, reducing pressures on the local biodiversity. The value of NBS for biodiversity enhancement in an urban environment is outlined in the EU Green Infrastructure strategy¹⁴.

NBS address the Air Quality Directive¹⁵ via alleviating urban air pollution, contributing to decreased local levels of particulate matter (PM_{2.5}, PM₁₀), nitrogen dioxide (NO₂) and ground-level ozone (O₃) for protection of human health. Explicitly addressing urban air pollution additionally contributes to the Clean Air Programme for Europe¹⁶.

Adaptation to the effects of climate change is equally reflected in the EU Bioeconomy Strategy and the EU Circular Economy Strategy¹⁷, both major constituents of the European Green Deal¹⁸. NBS can contribute to circularity by, e.g., facilitating the recycling or productive re-use of organic materials, or rainwater capture and re-use. The latter can significantly advance, for example,

¹⁰ OJ L 164, 25.6.2008, p. 19–40

¹¹ https://ec.europa.eu/echo/sites/echo-site/files/sendai_swd_2016_205_0.pdf

¹² OJ L 20, 26.1.2010, p. 7–25

¹³ OJ L 206, 22.7.1992, p. 7–50

¹⁴ COM/2013/0249 final

¹⁵ OJ L 152, 11.6.2008, p. 1–44

¹⁶ COM(2013) 918 final

¹⁷ COM/2020/98 final

¹⁸ COM/2019/640 final

the Water Scarcity and Droughts Policy¹⁹, while helping to advance the EU circular economy action plan²⁰ and approach through the water cycle

An abundance of EU legal acts ensures coordination within and across the policies and strategies, all aiming at strengthening regional development. Being interlinked by their nature, the Water Framework Directive itself encompasses the links to the EU climate change strategy and other policies, such as those related to agriculture (e.g., EU Common Agricultural Policy²¹) and green infrastructure. Strosser et al. (2015) remark that stakeholder participation and awareness raising, which NBS influence directly, contributes to a more successful implementation of the strategies outlined in the Directives. NBS projects, being participatory in their nature, directly influence the Open Science initiative established by the EU (EC, 2016) enabling education, research, and data-informed decision- and policymaking.

The EU Research and Innovation (R&I) policy agenda on NBS and Re-Naturing Cities aims to position the EU as leader in 'Innovating with nature' for more sustainable and resilient societies. The main goals of this EU policy agenda are to: (1) Enhance the framework conditions for NBS at EU policy level; (2) Develop an EU Research and Innovation Community for NBS; (3) Provide the evidence and knowledge base for NBS; (4) Advance the development, uptake and upscale of innovative NBS; and (5) Mainstream NBS within the international agenda. This agenda contributes to knowledge creation and policy development in relevant areas, such as biodiversity, water management, climate change mitigation and adaptation, sustainable development, and disaster risk reduction (EC, 2014; EC, 2020). This agenda proposes NBS as more effective and efficient solutions than more traditional approaches – turning environmental, social and economic challenges into innovation opportunities. At its core are the concepts of addressing societal challenges with nature, accounting for and maximising multiple benefits, co-creating and community building, establishing an evidence base and mainstreaming NBS in European and international policies. This handbook is the result of work carried out by Horizon2020 NBS projects funded under the EU R&I policy agenda.

1.2.2 NBS in an International policy context

Internationally, the Hyogo Framework for Action (HFA) 2005–2015 (UNISDR, 2005), is an international agreement under the auspices of the United Nations International Strategy for Disaster Reduction (UNISDR), aimed to reduce the loss of lives and damage to properties and overall economic impact from natural hazards to enhance the sustainability of nations and communities (Quevauviller and Gemmer, 2015). A lack of sufficient quantitative data necessary to evaluate various options and actions to mitigate the impacts of natural hazards was identified in the HFA. This lack of data has made monitoring the progress of disaster risk reduction (DRR) and climate change adaptation (CCA) particularly challenging (UNISDR, 2011). This Handbook contributes directly to the

¹⁹ COM(2007) 414 final

²⁰https://ec.europa.eu/environment/strategy/circular-economy-action-plan_en

²¹ OJ L 347, 20.12.2013, p. 549–607

acquisition of consistent and accurate data concerning impacts of actions undertaken to address natural hazards in a systematic way.

In the new international policy agendas for DRR and CCA, founded on the Sendai Framework for Disaster Risk Reduction (SFDRR) 2015-2030 (UNISDR, 2015) and the Paris Agreement²² on climate change, further effort was placed on more effectively measuring DRR and CCA progress. In line with this, the 17 United Nations (UN) Sustainable Development Goals (SDGs) identify a series of objectives, clear targets and set of indicators to enhance, monitor, and evaluate progress on environmental and human conditions (UN General Assembly, 2015). Local monitoring of progress towards SDG achievement is strongly supported by the impact evaluation framework presented herein. A number of the indicators associated with SDGs have been adopted as part of the present framework and are presented in this handbook and associated *Appendix of Methods*.

The HFA made little reference to nature or ecosystem-based approaches for DRR and CCA compared with its successor, the SFDRR. This new frame was endorsed by the UN General Assembly following the 2015 third UN World Conference on DRR (WCDRR), re-enforcing the change in prevailing paradigm, with the clear goal to build the resilience of nations and communities to disasters by shifting towards disaster risk management and prevention. With the SFDRR agreement, policy and decision-makers have committed to decrease global disaster damages by 2030 and have recognized the key role of measuring disaster losses in achieving this objective (UNISDR, 2015). The SFDRR has a global agenda in reducing and averting disaster risks by reinforcing adaptation in society and economic settings. It argues that DRR responsibility should be shared among the different stakeholders including local government, the private sector, and others. The SFDRR works in parallel with the other 2030 Agenda agreements, including the Paris Climate Change Agreement, the Addis Ababa Action Agenda on Financing for Development, the New Urban Agenda, and ultimately the 2030 Action Agenda for the SDGs. Many of these ambitious goals directly refer to the urban and peri-urban environments where most of the global population live and will increasingly expand in the future. However, as outlined, the impact of climate change is extended to wider territories and actions since often adaptation requires coordinated measures at a larger territorial scale.

Nature-based solutions can form a core element of local, regional, and national policy initiatives. The need for a more “natural” living environment is increasingly evident, with the importance of connecting with nature particularly recognised during the COVID19 pandemic, primarily in urban and peri-urban areas, and the public demands for greater attention to biodiversity and climate threats continue to grow at the local and global scales. According to Langer (1995), in order to achieve an ecological transformation of our economy and society, the process has to be “socially desirable” for the majority of people. Thus, because of EU and national level government incentives and directives and citizens’ requests, we are living during a period of significant transition. Local governments and institutions can employ this handbook as a tool to support the design and evaluation of NBS

²² United Nations Framework Convention on Climate Change. <https://unfccc.int/>

projects as part of the transition to a green, climate resilient and sustainable society.

1.3 Purpose of the NBS Impact Evaluation Handbook

The need for robust methods, frameworks and indicators that allow the quantification and the multiple levels of interaction associated to NBS, from co-design to implementation is clear. This handbook provides a protocol for selection of key indicators of NBS impact and methods for their assessment, which can be applied to monitor reference parameters. The handbook adopts the EKLIPSE Working Group impact evaluation framework approach with key challenge-based indicators (Raymond et al., 2017). Building on the EKLIPSE framework, which was primarily designed for urban areas, this handbook extends the original EKLIPSE challenge areas to address additional challenges and scales of NBS application (see Chapter 4 for details).

1.3.1 Handbook aim

This handbook offers an overall evaluation framework for NBS. It covers the technical scope related to the monitoring processes relevant to stakeholders who are involved in NBS assessment and implementation, such as the research community, technology providers, authorities and NBS implementers. The sequence of NBS evaluation framework development and implementation are addressed from the conception-design and implementation of a monitoring and evaluation plan through NBS monitoring and final evaluation of benefits and dis-benefits. The indicators of NBS impact detailed within this handbook and the accompanying *Appendix of Methods* encompass environmental, social, and economic domains in the NBS assessment.

This handbook and its *Appendix of Methods* should be regarded as living documents. Increases in scientific knowledge and the accumulation of evidence on NBS performance and impact, together with technological advances, will necessitate changes and updates to accommodate advances in the field of NBS research. In addition, social and cultural change may alter how NBS are viewed by decision-makers and the wider public, as well as the policy context within which we view NBS. The authors anticipate periodic updates to this handbook to account for changes to the scientific, technological, social, cultural, and political landscape and the resultant impact on how we understand and use NBS.

In summary, the handbook serves as a comprehensive reference handbook, based upon current best available knowledge and state-of-the-art technologies and practices. It provides detailed information to guide the development and implementation of an NBS monitoring and evaluation plan, and the use of the NBS impact indicators presented as a query tool. This handbook contributes to the provision of sustainable nature-based alternatives to environmental challenges while addressing growing demands for the peaceful coexistence between nature and humans (Sánchez et al., 2020).

1.3.2 *Intended audience of this handbook*

This handbook presents information in a way that aims to make NBS accessible to educated non-experts, including all individuals and organisations interested in NBS but primarily focused on the individuals and groups involved in creating, implementing, and evaluating NBS. We focus on a “non-expert” audience because NBS are capable of addressing numerous societal challenges while providing a range of co-benefits across multiple expert domains. It is unlikely that a single individual or even a single group of people will possess high-level expertise across all domains addressed by NBS. Thus, this handbook aims to provide critical background on the NBS concept and where it fits in a European and international policy context, knowledge regarding the essential steps in developing and implementing a monitoring and evaluation plan, guidance on the selection and application of indicators of NBS impact, and knowledge of data to support effective data management and use in NBS assessment.

The handbook, as an enabler of NBS knowledge, provides a user-friendly way to plan, monitor and evaluate NBS. In this sense, the handbook functions a tool for the main stakeholders of the NBS value chain to facilitate an improved understanding of NBS impacts inform NBS implementation to address identified concerns. In this sense, this handbook targets several NBS stakeholder groups, including but not limited to:

- **Policy makers, urban planners and other public agents** involved in urban development and land management. The handbook can aid the development of coherent strategies for sustainable development, climate change adaptation and mitigation, biodiversity enhancement, disaster risk reduction, and a just transition and deep transformation towards climate change resilience at both urban and regional scales. It can support stakeholders in the development and implementation of NBS monitoring and evaluation plans within the area of intervention as a tool assess the achievement of specified objectives, thus providing valuable evidence of NBS effectiveness and informing management actions.
- **Members of the scientific community** who wish to deepen their knowledge on state-of-the-art tools and methods available for monitoring progress towards specific, measurable environmental, social and economic objectives, and to gather evidence regarding the provision of ecosystem services (ESS) by NBS.
- **Businesses, nature-based enterprises, impact investors, and industries** involved in the design, construction, and management of NBS, or interested in the utilisation of or investing into the services that NBS provide.
- **Non-governmental organisations and civil society at large** who are interested in understanding the environmental, social, and economic impacts of NBS and in gathering knowledge on the existing tools for quantifying NBS impact will benefit from the comprehensive background knowledge and detailed steps for key processes presented in this handbook. In addition, this handbook provides information to support the

active engagement of citizens in the acquisition of data related to NBS performance and impact through local monitoring programs, such as citizen science or crowdsourcing of information.

1.3.3 *How this handbook was developed*

This handbook was developed by a large group of experts from several NBS-related EU H2020 funded projects and European programmes to support the development of a European evidence base on NBS performance and impact. Over the past decade, the EC has adopted a series of strategies in response to the challenges arising from anthropogenic pressures on the environment and observed increases in natural hazards related to anthropogenic climate change. Many of these strategies were focused on sustainable actions to mitigate the risks derived from the human exposure to different kinds of threats. Specifically, from 2015 a large investment in research and development was made to improve knowledge regarding NBS processes and functions, demonstrate their application and derive evidence of NBS performance and impact across a range of different application contexts. This translated into more than twenty H2020 projects and programmes directly addressing the area of NBS and closely related themes, including but not limited to (in alphabetical order): BiodivERsA, CLEARING HOUSE, CLEVER Cities, CONNECTING Nature, EdiCitNet, EKLIPSE, GREEN SURGE, GROW GREEN, Inspiration, MAES/EnRoute, NAIAD, Nature4Cities, Naturvation, NetworkNature, OpenNESS, OPERAs, OPERANDUM, PHUSICOS, proGireg, RECONNECT, REGREEN, Think Nature, TURaS, UNaLab, URBAN GreenUP, and URBiNAT.

Table 1-1 illustrates the wide range of main objectives and expected outcomes from these projects. The Projects range from those directly addressing the NBS impact on climate change and water related issues in urban, rural and natural areas, to others addressing the NBS impact on social cohesion, or links to the insurance industry, and hydro-meteorological risks. More recently, project scopes expanded to evaluating impacts on biodiversity and ecological restoration, and collaborating with other global regions, such as China or Latin America. Several web portals, networks, platforms and initiatives have been developed to address NBS at European, national and sub-national levels. A non-exhaustive list of networks, platforms and initiatives includes OPPLA²³, NetworkNature²⁴, BiodivERsA²⁵, Biodiversity Information System for Europe (BISE)²⁶, ThinkNature²⁷, the European Climate Adaptation Platform Climate-ADAPT²⁸, Natural Water Retention Measures NWRM platform²⁹, and the EC Disaster Risk Management Knowledge Centre (DRMKC)³⁰.

²³ <https://oppla.eu/>

²⁴ <https://networknature.eu/>

²⁵ <https://www.biodiversa.org/>

²⁶ <https://biodiversity.europa.eu/>

²⁷ <https://www.think-nature.eu/>

²⁸ <https://climate-adapt.eea.europa.eu/>

²⁹ <http://nwrn.eu/>

³⁰ <https://drmkc.jrc.ec.europa.eu/>

To integrate the outputs and promote the synergies emerging from these large H2020 projects, several taskforces (TFs) were established linking the projects and facilitating collaboration and knowledge exchange. These taskforces are comprised of representatives from each of the H2020 NBS projects, representatives of the Coordination and Support Action responsible for development and management of the NBS Stakeholders platform, representatives from EASME and DG RTD, and external observers from related programmes and initiatives. The six taskforces are: TF1 - Data Management and EU NBS Knowledge Repository; TF2 - NBS Impact Evaluation Framework; TF3 -: Governance, Business Models and Financial Mechanisms; TF4 - NBS Communication; and TF6 - Co-creation for NBS. The number of NBS taskforces and the focus of each will continue to evolve with time as new needs are identified.

The present handbook was developed by members of TF2, whose collaborative effort aimed at establishing a dynamic NBS impact evaluation framework based on the collective experience acquired through execution of the NBS projects. One of the primary goals of the taskforces is to jointly demonstrate the effectiveness of NBS by providing a scientific evidence base detailing the performance and impacts of NBS of different types as implemented in different contexts, and to compile and disseminate best practices and guidelines for NBS development and implementation based on participatory processes. Through concerted actions, like this handbook, the taskforces are helping to define the framework to strengthen NBS-based policies in accordance with local legislation, cultures and social norms, while supporting new technologies and innovation in the area of NBS to promote European leadership in the field.

Table 1-2. Summaries of previous and ongoing projects and programmes working on NBS (2007-2022).

Projects related to NBS	Aims, targets and brief summary	Reference
BiodivERsA	BiodivERsA is a network of national and regional funding organizations promoting pan-European research on biodiversity and ecosystem services, and it is offering innovative opportunities for the conservation and sustainable management of biodiversity.	http://www.biodiversa.org/
CLEARING HOUSE	CLEARING HOUSE is the first Sino-European research project on urban forests and urban trees as nature-based solutions. We look into how a traditional solution as urban trees can contribute to sustainable cities. The project aims to develop an online application, a global benchmark tool, and guidelines to support the design, governance and management of urban forests.	http://clearinghouseproject.eu/
CLEVER Cities	CLEVER Cities aims to increase and improve local knowledge of nature-based solutions, demonstrate that greener cities work better for people and communities, contribute data and information to EU policy-making, and ultimately promote and enable the uptake of nature-based solutions in urban planning world-wide.	https://clevercities.eu/
CONNECTING Nature	CONNECTING Nature brings in actions to feed the initiation and expansion of economic and social enterprises in production and large-scale implementation of NBS in urban settings to measure the impact of these initiatives on climate change adaptation, health and well-being, social cohesion and sustainable economic development.	https://connectingnature.eu/
EdiCitNet	The Edible Cities Network focuses on Edible City Solutions, defined as NBS related to urban food production, distribution and use. EdiCitNet implements, monitors and transfers Edible City Solutions in close cooperation with city authorities and other local stakeholders. Thereby, it aims at increasing social, environmental and economic sustainability of cities.	https://www.edicitnet.com/

EKLIPSE	EKLIPSE aims to develop support mechanisms that facilitate linkages between science, policy and society, through different actions such as knowledge synthesis, identifying research priorities, and building the Network of Networks that will support the other actions	http://www.eclipse-mechanism.eu/
EnRoute	EnRoute is a project of the European Commission in the framework of the EU Biodiversity Strategy and the Green Infrastructure Strategy. EnRoute provides scientific knowledge of how urban ecosystems can support urban planning at different stages of policy and for various spatial scales and how to help policy-making for sustainable cities.	https://oppla.eu/groups/enroute
GREEN SURGE	GREEN SURGE prepared strategies to design urban green approaches: integrating green and grey approaches, connecting green areas, utilizing the multipurpose character of the green approach and involving citizens in urban planning.	https://cordis.europa.eu/project/id/603567
GROW GREEN	GROW GREEN aims to invest in NBS (high-quality green spaces and waterways) while long term city planning to develop climate and water resilience, strong and habitable cities, capable of dealing major urban challenges, such as flooding, heat stress, drought, poor air quality, unemployment and biodiversity-loss.	http://growgreenproject.eu/
Inspiration	Inspiration aimed to develop a Strategic Research Agenda (SRA) to inform environmentally friendly, socially acceptable and economically affordable soil and land use management that meets societal needs and challenges. A SRA built on end-user knowledge needs is more likely to be enthusiastically adopted by funders in order to promote the knowledge creation, transfer and implementation agenda.	http://www.inspiration-h2020.eu/
MAES	The Working Group on Mapping and Assessment on Ecosystems and their Services (MAES) was established under the Common Implementation Framework (CIF) to support the effective delivery of the EU Biodiversity Strategy to 2020. The objective of the MAES	https://ec.europa.eu/environment/nature/knowledge/ecosystem_assessment/index_en.htm

	<p>Working Group is to provide guidance for the implementation of Action 5 by the EU and its Member States, including development of a coherent analytical framework to be applied by the EU and its Member States in order to ensure consistent approaches are used to map ecosystems and their services.</p>	
NAIAD	<p>NAIAD is focused on developing a strong conceptual framework for evaluating the assurance and the insurance value of ecosystem services. The project has developed the concept of natural assurance schemes, and the range of tools and methods to design them, ranging from physical, social and economic assessment, integration and co-design with stakeholders, to the development of business models and financing arrangements, and finally implementation and monitoring. Stakeholders involved included insurers, river basin agencies and local authorities, in the validation and application in nine case study sites across Europe.</p>	<p>http://naiad2020.eu/</p>
Nature4Cities	<p>Nature4Cities aims for a positive balance between economic, environmental and societal benefits and costs by creating a reference platform for NBS, offering technical solutions, methods and tools for urban planning. This balance entails collaborative models from citizens, researchers, policymakers and industry leaders through co-creation processes.</p>	<p>https://www.nature4cities.eu/</p>
NATURVATION	<p>NATURVATION assesses NBS achievements in cities, examines their innovation process and works with communities and stakeholders to develop the knowledge and tools required for the recognition of NBS potential for meeting urban sustainability goals.</p>	<p>https://naturvation.eu/</p>
NetworkNature	<p>NetworkNature is a European and global platform providing resources for the nature-based solutions community and creating opportunities for local, regional and international cooperation to maximise the impact and mainstreaming of NBS. All interested stakeholders can access and contribute cutting-edge, innovative knowledge and expertise on NBS to the NetworkNature platform.</p>	<p>https://networknature.eu/</p>

OpenNESS	OpenNESS aims to translate the concepts of Natural Capital (NC) and Ecosystem Services (ESS) into operational frameworks that provide tested, practical and tailored solutions for integrating ESS into land, water and urban management and decision-making. It examines how the concepts link to, and support, wider EU economic, social and environmental policy initiatives.	http://www.openness-project.eu/
OPERAs	OPERAs combined NBS with traditional engineered solutions by constructing and maintaining semi-fixed dunes on Barcelona's (Spain) urban coastline, aiming to optimize ecosystem benefits and augment coastal defence against sea-level rise.	https://www.operas-project.eu/
OPERANDUM	OPERANSUM is developing a set of co-designed, co-developed, deployed, tested and demonstrated innovative NBS for the management of the impact of hydro-meteorological risks (HMRs), especially focused in European rural and natural territories, facilitating the adoption of new policies for the reduction of HMRs via NBS and their promotion.	https://www.operandum-project.eu
PHUSICOS	PHUSICOS is demonstrating the effectiveness of NBS and their ability to reduce the impacts from small, frequent events (extensive risks) in rural mountain landscapes.	https://phusicos.eu
proGIreg	proGIreg focuses on the implementation and observation of eight different NBS for creating productive GI to improve living conditions and reduce vulnerability to climate change, and to provide measurable economic benefits to citizens and entrepreneurs in post-industrial urban districts.	www.progireg.eu
RECONNECT	RECONNECT aims to rapidly enhance the European reference framework on NBS for hydro-meteorological risk reduction by demonstrating, referencing, upscaling and exploiting large-scale NBS in rural and natural areas.	http://www.reconnect.eu/

REGREEN	REGREEN aims to substantially advance evidence and tools by systematically modelling and combining ecosystem services and biodiversity as the basis for urban NBS in Europe and China. This also involves policy experimental learning, strategies for depavement, education and citizen science in schools, valuation of benefits and costs and the development of business models for realising spatially relevant NBS that provide multiple ecosystem services and wellbeing.	https://www.regreen-project.eu/
ThinkNature	ThinkNature developed a platform that supports the widespread understanding and the promotion of NBS.	https://www.think-nature.eu/
TURaS	TURaS offers examples of approaches for enhancing urban sustainability, e.g., green walls that can be adopted in any location and at an affordable cost.	https://cordis.europa.eu/project/id/282834
UNaLab	UNaLab aims to develop a European Reference Framework on benefits, cost-effectiveness, economic viability and replicability of NBS by promoting smart, inclusive, resilient and sustainable urban communities through co-creation (with and for local stakeholders) of Urban Living Lab (ULL), demonstrations, experiments and evaluation of NBS for climate and water challenges.	https://unalab.eu/
URBAN GreenUP	URBAN GreenUP aims to develop, apply and validate a methodology for Renaturing Urban Plans to mitigate the effects of climate change, improve air quality, water management and increase the sustainability of cities through innovative NBS.	https://www.urbangreenup.eu/
URBiNAT	URBiNAT focuses on the regeneration and integration of deprived social housing districts. Interventions focus on the public space to co-create with citizens new urban, social and nature-based relations within and between different neighbourhoods. URBiNAT aims to co-plan a healthy corridor as an innovative and flexible NBS, integrating micro NBS emerging from community-driven design processes.	www.urbinat.eu

1.4 Content of this handbook

A wealth of scientific evidence demonstrates that NBS are capable of addressing challenges across multiple environmental, social, cultural and economic dimensions. In this handbook, we consider the impacts on the following 12 key societal challenge areas (Figure 1-2):

1. Climate Resilience
2. Water Management
3. Natural and Climate Hazards
4. Green Space Management
5. Biodiversity Enhancement
6. Air Quality
7. Place Regeneration
8. Knowledge and Social Capacity Building for Sustainable Urban Transformation
9. Participatory Planning and Governance
10. Social Justice and Social Cohesion
11. Health and Wellbeing
12. New Economic Opportunities and Green Jobs

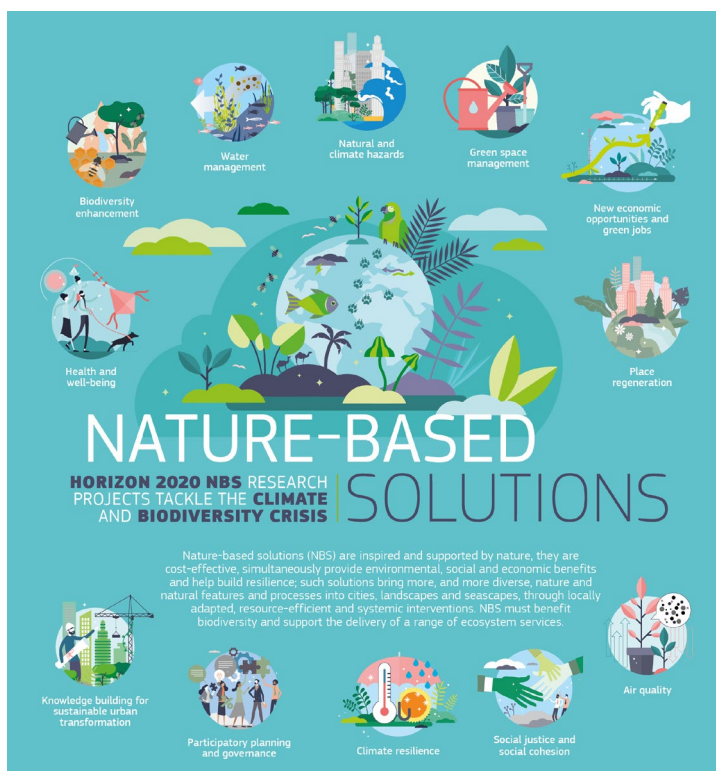

Figure 1-2. What are nature-based solutions (NBS)? (Image © European Union, 2021)

A core principle of NBS lies in responding to one or more societal challenges that have been identified as a priority by the local community (IUCN, 2020). This handbook provides additional information about each of the aforementioned 12 key societal challenge areas and how they can be addressed by NBS. One of the most important concerns expressed by a large proportion of the world's population is climate change and its effects, including floods, droughts, heat islands, biodiversity loss, and other impacts. Nature-based solutions are increasingly viewed as a viable approach to sustainably address the negative impacts of climate change, both in terms of climate change adaptation and mitigation. Many urban areas can be uncomfortable to inhabit due to air and water pollution, traffic and industrial noise, violence, and the impacts of climate change-related extreme weather events. Some urban residents also cite concerns regarding a lack of social cohesion, lack of physical activity and the absence of nature³¹. The introduction of green spaces and other types of NBS have been shown to enhance urban liveability, for example, by reducing heat stress and enhancing human thermal comfort (Majidi et al. 2019).

Monitoring and evaluation is essential to determine whether implemented NBS respond effectively to the challenges identified. **Chapter 2** of this handbook describes the main principles guiding NBS performance and impact evaluation, including the general steps in the development of a credible monitoring and evaluation plan that is tailored to a specific local context. The NBS project life cycle assessment is a cyclical process rather than sequential and may require reassessing or changing plans at any point in the process (Figure 1-3).

Of these processes, the monitoring and impact evaluation phase of an NBS project is based on a holistic approach capable of illustrating the wider benefits and trade-offs of NBS and their impacts in a systematic way. The monitoring and evaluation phase of the project comprises both observation (monitoring) and analysis (assessment by stakeholders or end-users) of the respective NBS project's impact. Thus, the goal of monitoring and evaluation is to analyse, interpret and document the outcome of an NBS project for use by policymakers, stakeholders, and decision-makers at various levels. **Chapter 3** of this handbook outlines a stepwise approach to the development and implementation of an NBS monitoring and evaluation plan. The chapter describes how to engage in a structured process to connect strategic objectives with NBS actions and expected outcomes. Chapter 3 presents a series of examples of innovative monitoring and evaluation support tools developed in EC H2020 projects.

Monitoring and impact evaluation of NBS is supported by indicators of NBS performance and impact, including biophysical, socio-economic and sustainability indicators, which are targeted to the evaluation of specific aspects of NBS effectiveness. **Chapter 4** of this handbook describes the 12 categories of societal challenges that can be addressed by NBS, and conceptually maps the 12 challenge areas against the UN Sustainable Development Goals. A series of indicators to evaluate the performance and impact of NBS are presented in Chapter 4, organised by challenge area and further separated into Recommended

³¹ <http://www.euro.who.int/en/health-topics>

and Additional indicators to support the development of a holistic monitoring and evaluation scheme. The accompanying **Appendix of Methods** provides brief descriptions of the techniques used to assess each indicator listed in the handbook, and guides the implementation of selected indicators to assess NBS performance and impact.



Figure 1-3. A schematic diagram showing the full life cycle of NBS such as monitoring and evaluation, cost-benefit analysis (adapted from Kumar et al., 2020)

The *Recommended indicators* presented in Chapter 4 are considered the most important ones to monitor NBS impact; however, the *Additional indicators* of NBS impact can provide highly valuable information, depending on local context and particular data needs. **Chapter 5** presents several case studies from different NBS projects illustrating the selection and application of both *Recommended* and *Additional NBS impact indicators*. This chapter provides examples of how different groups of indicators were selected to address specific questions. Each case study presented in Chapter 5 includes a brief description of the NBS, the reasons for the selection of specific indicators for that particular NBS and a brief overview of how the indicators are applied and/or monitored. The case studies also describe the stakeholders involved in co-design and co-monitoring of NBS and discuss the barriers and lessons learned during or after NBS implementation, monitoring and evaluation.

Chapter 6 of the handbook specifically addresses the implementation of NBS to mitigate the impact of hydro-meteorological events, detailing experiences to date and providing examples of NBS application for hydro-meteorological risk reduction. This chapter begins with an overview of hydro-meteorological risk and illustrates how a hybrid combination of NBS and technical engineering solutions (green-grey solutions) can be particularly effective in DRR and natural assurance or (re)insurance schemes. The case studies in Chapter 6 provide examples of different combinations of indicators and assessment models that can be used to evaluate the technical, physical, economic, social, and environmental performance and impact of NBS implemented for DRR.

Monitoring and evaluation of NBS is based upon data. How do we know which type of data is most appropriate, and the potential sources of data? The *Appendix of Methods* briefly outlines the data required to determine each NBS impact indicator listed in Chapter 4, and the case studies presented in Chapters 5 and 6 illustrate how the indicators have been applied to different NBS. **Chapter 7** reviews the main types of data, sources of data and techniques used to generate data for NBS monitoring and impact evaluation. This chapter is an important resource during NBS monitoring and evaluation planning, as the content of Chapter 7 aids the development of a robust, actionable plan for the collection, management and use of data in NBS impact assessment.

1.5 Conclusions

In the face of current global challenges, particularly the need to adapt to and mitigate climate change, it is essential that spatial and urban planning and management find ways to effectively integrate climate action, from both the mitigation and adaptation perspectives. Nature-based solutions integrate knowledge and practices from numerous related concepts such as EbA, Eco-DRR, LID, GI, SuDs, and WSUD with extensive stakeholder engagement through co-creation, co-implementation, and co-management actions throughout the NBS lifecycle. The capacity of NBS to deliver a broad range of environmental, economic and social co-benefits is widely recognised by practitioners and policy-makers alike, and increasingly highly valued by citizens themselves. Nature-based solutions are a core element of European CCA and biodiversity strategies (EC, 2020; EC, 2021). Nature-based solutions can also contribute substantially to the achievement of the UN SDGs, particularly targets under SDG 11 Sustainable cities and communities. Whilst not explicitly mentioned in the Sendai Framework for DRR, NBS can play a key role in disaster risk management and prevention through the adoption of Eco-DRR strategies.

Robust evaluation of NBS performance and impact is essential to fully understand their benefits and trade-offs. Monitoring and evaluation facilitates an understanding of how NBS performance and impacts evolve with time, and provides insights into their respective potential for up-scaling and replication according to stakeholder needs and the local context (environmental, social, and economic conditions). Major challenges for up-scaling and replication of NBS arise from a lack of detailed and standardised monitoring methods, reporting protocols and guidance at the different stages of the NBS life cycle.

The International Union for the Conservation of Nature (IUCN) recently released standards for the design and assessment of NBS to support mainstreaming of nature conservation and consistency of NBS application (IUCN 2020). Whilst the IUCN standard does not cite definitive thresholds, it provides a systematic framework to facilitate and support consistency in NBS design and assessment based on solutions-oriented outcomes. This handbook is intended to provide standardised methods of NBS monitoring and evaluation, reporting protocols, and guidance based upon best practices learned during NBS project work. The NBS impact evaluation framework, indicators and methods described in this handbook are strongly aligned with the eight criteria and sub-indicators that comprise the standard framework for NBS design and assessment defined by the IUCN (2020).

Monitoring and evaluation of NBS is essential, not only to measure the “success” of individual NBS projects, but to inform further actions and provide evidence to support effective land use planning and management, and policy-making. This handbook serves a guide to developing and implementing an appropriate, scientifically robust NBS monitoring and evaluation plan to support NBS management to achieve targeted objectives as well as NBS replication and up-scaling efforts. The generation and dissemination of monitoring and evaluation data will promote further NBS actions, creating a positive cycle for the generation of an increasingly detailed knowledge base on NBS efficiency and cost-effectiveness in comparison with traditional grey approaches (Kabisch et al. 2016).

1.6. References

- Debele, S.E., Kumar, P., Sahani, J., Marti-Cardona, B., Mickovski, S.B., Leo, L.S., Porcù, F., Bertini, F., Montesi, D., Vojinovic, Z., Di Sabatino, S., 'Nature-based solutions for hydro-meteorological hazards: Revised concepts, classification schemes and databases', *Environmental Research*, Vol. 179, 2019, pp. 1-20.
- Dorst, H., van der Jagt, A., Raven, R., and Runhaar, H., 'Urban greening through nature-based solutions – Key characteristics of an emerging concept', *Sustainable Cities and Society*, Vol. 49, 2019, 101620.
- Eisenberg, B., Polcher, V., Chiesa, C., *Nature Based Solutions Technical Handbook*, D5.1 NBS Technical Handbook, 31/05/18, Deliverable 5.1 for the UNaLab H2020 project, GA no. 730052, 2018.
- Escobedo, F.J., Giannico, V., Jim, C.Y., Sanesi, G., and Laforteza, R., 'Urban forests, ecosystem services, green infrastructure and nature-based solutions: Nexus or evolving metaphors?', *Urban Forestry and Urban Greening*, Vol. 37, 2019, pp. 3–12.
- European Commission, *A sustainable bioeconomy for Europe: strengthening the connection between economy, society and the environment. Updated Bioeconomy Strategy*, Publications Office of the European Union, Luxembourg, 2018.
- European Commission, *Forging a climate-resilient Europe - the new EU Strategy on Adaptation to Climate Change*, COM/2021/82 final, Brussels, 24.2.2021.
- European Commission, *Nature-based solutions & re-naturing cities. Final report of the Horizon 2020 expert group on 'Nature-Based solutions and Re-Naturing cities'*, Publications Office of the European Union, Luxembourg, 2015.
- European Commission, *Nature-Based Solutions: State of the Art in EU-funded Projects*, Publications Office of the European Union, Luxembourg, 2015, 2020.
- European Commission, *Open Innovation, Open Science, Open to the World – A vision for Europe*, Publications Office of the European Union, Luxembourg, 2016.

- European Commission Towards a research and innovation policy agenda for Nature-based Solutions and Renaturing Cities <https://op.europa.eu/en/publication-detail/-/publication/fb117980-d5aa-46df-8edc-af367cddc202> 2014
- Faivre, N., Fritz, M., Freitas, T., de Boissezon, B., and Vandewoestijne, S., 'Nature-Based Solutions in the EU: Innovating with nature to address social, economic and environmental challenges', *Environmental Research*, Vol. 159, 2017, pp. 509–518.
- Frantzeskaki, N., Bergström, S., Gorissen, L., Egermann, M. and Ehnert, F., 'Nature-Based Solutions Accelerating Urban Sustainability Transitions in Cities: Lessons from Dresden, Genk and Stockholm Cities', *Nature-Based Solutions to Climate Change Adaptation in Urban Areas. Theory and Practice of Urban Sustainability Transitions*, Cham, Springer, 2017, pp. 65-88.
- International Union for the Conservation of Nature, *IUCN Global Standard for Nature-based Solutions. A user-friendly framework for the verification, design and scaling up of NbS. First Edition*. Gland, International Union for the Conservation of Nature, 2020.
- Kabisch, N., Frantzeskaki, N., Pauleit, S., Naumann, S., Davis, M., Artmann, M., Haase, D., Knapp, S., Korn, H., Stadler, J., Zaunberger, K., and Bonn, A., 'Nature-based solutions to climate change mitigation and adaptation in urban areas: perspectives on indicators, knowledge gaps, barriers, and opportunities for action', *Ecology and Society*, Vol. 21, No 2, 2016, p. 39.
- Langer, A., *Il viaggiatore leggero. Scritti (1961 – 1995)*, Sellerio, Palermo, 1995.
- Majidi, A. N., Vojinovic, Z., Alves, A., Weesakul, S., Sánchez, A., Boogaard, F., and Kluck, J., 'Planning Nature-Based Solutions for Urban Flood Reduction and Thermal Comfort Enhancement', *Sustainability*, Vol. 11, No 22, 2019, Art. no 6361.
- Marchal, R., Piton, G., Lopez-Gunn, E., Zorrilla-Miras, P., Van der Keur, P., Dartée, K.W., Pengal, P., Matthews, J.H., Tacnet, J.-M., Graveline, N., Altamirano, M.A., Joyce, J., Nanu, F., Groza, I., Peña, K., Cokan, B., Burke, S. And Moncoulon, D., 'The (Re)Insurance Industry's Roles in the Integration of Nature-based Solutions for Prevention in Disaster Risk Reduction—Insights from a European Survey', *Sustainability*, Vol. 11, No 22, 2019, Art. No 6212.
- 'Natural language: the latest attempt to brand green practices is better than it sounds', *Nature*, 541, 2017, pp. 133–134.
- Quevauviller, P. and Gemmer, M., 'EU and international policies for hydrometeorological risks: operational aspects and link to climate action', *Advances in Climate Change Research*, Vol. 6, 2015, pp. 74-79.
- Raymond, C.M., Pam, B., Breil, M., Nita, M.R., Kabisch, N., de Bel, M., Enzi, V., Frantzeskaki, N., Geneletti, D., Cardinaletti, M., Lovinger, L., Basnou, C., Monteiro, A., Robrecht, H., Sgrigna, G., Munari, L., Calfapietra, C., *An Impact Evaluation Framework to Support Planning and Evaluation of Nature-based Solutions Projects, An EKLIPSE Expert Working Group report*, Centre for Ecology and Hydrology, Wallingford, 2017.
- Rockström, J., Steffen, W., Noone, K., Persson, Å., Chapin, F.S., III, Lambin, E., Lenton, T.M., Scheffer, M., Folke, C., Schellnhuber, H.J., and Nykvist, B., 'Planetary boundaries: exploring the safe operating space for humanity', *Ecology and society*, Vol. 14, No 2, 2009, p. 32.
- Ruangpan, L., Vojinovic, Z., Di Sabatino, S., Leo, L. S., Capobianco, V., Oen, A.M.P., McClain, M.E., and Lopez-Gunn, E., 'Nature-based solutions for hydro-meteorological risk reduction: a state-of-the-art review of the research area', *Natural Hazards and Earth System Sciences*, Vol. 20, 2020, pp. 243–270.
- Sahani, J., Kumar, P., Debele, S., Spyrou, C., Loupis, M., Aragão, L., Porcù, F., Shah, M.A.R., Di Sabatino, S., 'Hydro-meteorological risk assessment methods and management by nature-based solutions', *Science of the Total Environment*, Vol. 696, 2019, Art. No 133936.
- Science for Environment Policy (SEP), 'The solution is in nature. Future Brief 24. Brief produced for the European Commission DG Environment', UWE Bristol Science Communication Unit, , Bristol, 2021.
- Strosser, P., Delacámara, G., Hanus, A., Williams, H., and Jaritt, N., *A guide to support the selection, design and implementation of Natural Water Retention Measures in Europe - Capturing the multiple benefits of nature-based solutions*, Publications Office of the European Union, Luxembourg, 2015.
- UNISDR, 'Hyogo Framework for Action 2005-2015: Building the Resilience of Nations and Communities to Disasters', Geneva, United Nations Office for Disaster Risk Reduction, 2005.
- UNISDR, 'Hyogo Framework for Action 2005-2015 mid-term review', Geneva, United Nations Office for Disaster Risk Reduction, 2011.
- UNISDR, 'Sendai framework for disaster risk reduction 2015–2030', Proceedings of the Third United Nations World Conference on DRR, 14-18 March 2015, Sendai, Japan, United Nations Office for Disaster Risk Reduction, 2015.

**Drawing on knowledge from projects
funded by the European Union**



Nature4Cities

**Nature Based Solutions for re-naturing cities:
knowledge diffusion and decision support platform
through new collaborative models**

Ankara (TR)

Alcala de Henares (ES)

Metropolitan Milan (IT)

Szeged (HU)

Designed for Policy makers & public urban planners, urban professionals and civil society theNature4Cities platform aims to provide them support at all stages of a NBS project. The structure of the platform developed by the Nature4Cities Horizon 2020 project follows a support framework made up of three stages presented here.

SCOPE Technical solutions, methods and tools to empower urban planning decision making and address the contemporary environmental, social and economic challenges that European Cities are facing.

Create a NBS project

Applying from the creation of an NBS project, the platform offers users the challenge of choosing the right approach to meet their needs. It is proposed to use the NBS explorer to learn about specific NBS and their benefits and to work with the project observatory to learn from realized success projects. The pre-selection tool provides support to select a specific NBS type that meets their urban challenges and constraints. Finally, others tools based on satellite imagery analysis offer the possibility to diagnostic city trends and to identify the best place to implement a specific NBS project.

Assess a NBS project

The assessment stage aims to increase the chances to meet the initial goals. It consists of proposing tools and methods to assess the impacts of a NBS project for urban resilience and for the environment and socio-economic features. A simplified assessment of urban performance is proposed to assess how a NBS can benefit its surroundings (insitu), a socio-economic assessment is proposed to estimate the socio-economic benefits, co-benefits and costs of a NBS project and an environmental assessment can be used to assess the impact of the NBS throughout its life cycle (exsitu).

Implement a NBS project

Once a project is ready to be launched, the Nature4Cities platform also offers tools and methods to build governance, financial and business models, to involve citizens and to build inclusive projects.

Municipal Administrations

Citizens

Scientists / Academia

Planning experts

Green businesses

Main Challenges addressed

1. Climate Resilience

2. Water Management

3. Natural and Climate Hazards

4. Green Space Management

5. Biodiversity

6. Air Quality

7. Place Regeneration

8. Knowledge and Social Capacity Building

9. Participatory Planning and Governance

10. Social Justice and Social Cohesion

11. Health and Wellbeing

12. New Economic Opportunities & Green Jobs

Lessons learned

Sharing the concerns about urban challenges with a wide range of stakeholders and involving them into the planning and decision process is essential to guarantee a fruitful incorporation of NBS. This early inclusion is fundamental to anticipate an NBS project by choosing an appropriate NBS and selecting the best place to face the challenges of the city given the urban context. This is the main contribution of the Nature4Cities platform which aims to provide the knowledge and tools necessary for the design phase upstream of the implementation of a NBS.

Learn more
about the project
www.nature4cities.eu

Learn more
about the platform
www.nature4cities-platform.eu



Drawing on knowledge from projects funded by the European Union



NATURVATION

NATure-based URban innoVATION

Newcastle (GB) Barcelona (ES) Utrecht (NL) Malmö (SE) Gyor (HU) Leipzig (DE)

NATure-based URban innoVATION is a 4-year project, funded by the European Commission and involving 14 institutions across Europe in the fields of urban development, geography, innovation studies and economics. Led by Durham University, NATURVATION's partnership includes city governments, non-governmental organisations and business. We will seek to develop our understanding of what nature-based solutions can achieve in cities, examine how innovation can be fostered in this domain, and contribute to realising the potential of nature-based solutions for responding to urban sustainability challenges by working with communities and stakeholders.

SCOPE Environmental and socio-economic benefits and impacts of NBS innovation at city-scale.

Approach to Impact Assessment

The Urban Nature Navigator (UNN) tool has been developed by the NATURVATION research project and it aims at enabling decision-makers to evaluate the contribution that NBS can make towards achieving their urban sustainability goals. The tool includes a process through which decision-makers can identify their urban sustainability priorities or challenges and assess the contributions of six types of NBS towards meeting those urban sustainability challenges. By providing insight into how NBS contribute to various sustainability goals, decision-makers may better understand the multiple benefits of NBS and the trade-offs involved when selecting between different interventions or understand how NBS may contribute to the sustainability goals that are prioritised by different stakeholders.

Involved Stakeholders and roles

The UNN was co-designed between November 2016 and March 2019, involving project research partners from Lund University, the Netherlands Environmental Assessment Agency, Durham University, Utrecht University, Central European University (Hungary) and Leibniz-Institut für Länderkunde. During the development of the UNN, stakeholders from the project partner cities (Barcelona, Gyor, Leipzig, Malmo, Newcastle and Utrecht) have been consulted in the form of stakeholder workshops, dialogues and interviews. The numbers of stakeholders who participated in the meetings varied from 8 to 45, and the stakeholder involved had different professional backgrounds (e.g. urban planners, representatives from the public authorities, and members of local NGOs and community groups). The results of the stakeholder consultation processes helped re-formulate certain aspects of the tool to be more user friendly.

Municipal Administrations (FR/FL)

Planning experts

Scientists / Academia

Schools and kindergartens

Consultant Companies and SMEs

Main Challenges addressed

1. Climate Resilience

2. Water Management

3. Natural and Climate Hazards

4. Green Space Management

5. Biodiversity

6. Air Quality

7. Place Regeneration

8. Knowledge and Social Capacity Building

9. Participatory Planning and Governance

10. Social Justice and Social Cohesion

11. Health and Wellbeing

12. New Economic Opportunities & Green Jobs

Lessons learned

The interdisciplinarity approach applied to the development of the UNN resulted in the creation of an impact assessment tool that integrates environmental and socio-economic impacts and can communicate potential benefits of NBS towards addressing various urban sustainability challenges. The UNN is based on the inclusion of various indicators that according to the tool development approach are considered credible, salient, legitimate and feasible to capture the multi-dimensional benefits of NBS based on solid scientific evidence. This bestows the tool a credible character although the application of such approaches should also reflect on the importance of current practices outside the academic fields. Although inter-and transdisciplinary processes can be challenging, the experience from working with different disciplinary researchers and stakeholders, highlighted the need for a clear planning process that include iterative stages as well as for periods to integrate stakeholder feedback.

Learn more
www.naturvation.eu



The Naturvation project has received funding from the European Union's Horizon 2020 research and innovation programme under grant agreement No 730243

**Drawing on knowledge from projects
funded by the European Union**

THINK NATURE

Platform for Nature-based Solutions

The main objective of ThinkNature project is the development of a multi-stakeholder communication platform that will support the understanding and the promotion of nature-based solutions in local, regional, EU and International level. Through dialogue uptake facilitation and steering mechanisms as well as knowledge capacity building, the ThinkNature Platform brings together multi-disciplinary scientific expertise, policy, business, and society, as well as citizens. This platform is fluent to use and attractive to a wide variety of actors and stakeholders because it merges all aspects of NBS in a clear, pyramidal methodological approach. It creates a wide interactive society that builds new knowledge with a wide geographical scope.

SCOPE The objective of the ThinkNature project is the development of a platform that supports the understanding and the promotion of Nature-Based Solutions (NBS).

Approach to Impact Assessment

The ThinkNature platform is an integrated multi-stakeholder web solution designed to stir dialogue and interaction on NBS through discussion forums and debates in order to identify regulatory, economic and technical barriers and to communicate and promote successful NBS (<https://platform.think-nature.eu/>). The platform has private and publicly accessible sections. The public section of the platform is the NBS Knowledge Hub which includes NBS projects, Case studies, Resources. The private section of the platform is used to foster the dialogue on issues related to NBS, stakeholder networking and has the capability of hosting sections with restricted access. Having all functionalities to share documents, tasks and events, the users are encouraged to participate in online brainstorming forums and debates and enhance their knowledge of NBS. The networking hub brings together multi-disciplinary NBS expertise.

Involved Stakeholders and roles

The ThinkNature strategy for stakeholder engagement has a three-prong approach:

1. Establishment of the regional stakeholder networks – Four regional ‘think and do’ tanks covering the Mediterranean, Oceanic, Temperate Continental and Northern Temperate regions have been established with their respective networks of local representatives.
2. Brainstorming forums – ThinkNature organised two brainstorming forums to engage stakeholders in the uptake of NBS at the regional and local levels. More than 300 stakeholders participated. The forums made a significant contribution to the science-policy-business-society multi-stakeholder dialogue on NBS.
3. Barrier landscape and policy analysis - ThinkNature aimed to develop strategies to overcome existing barriers and decision-making hierarchy coupled with the engagement of local stakeholders in addressing NBS as part of EU, regional and local strategies.

Municipal Administrations

Citizen

Scientists / Academia

Green businesses

Architects and Spatial Planners

Construction and infrastructure companies

Main Challenges addressed

1. Climate Resilience

2. Water Management

3. Natural and Climate Hazards

4. Green Space Management

5. Biodiversity

6. Air Quality

7. Place Regeneration

8. Knowledge and Social Capacity Building

9. Participatory Planning and Governance

10. Social Justice and Social Cohesion

11. Health and Wellbeing

12. New Economic Opportunities & Green Jobs

Lessons learned

Wide communication of NBS is needed for both public administration units and citizens. Regarding citizens, enhancing public knowledge about NBS can increase public awareness and affect the attitude of citizens concerning these solutions, which can influence local decisions about NBS. In the context of enabling effective communication, technical information should be translated for the target groups. All available information should be localised and interpreted so that impacts, and risks are easily understandable. As to impacts and focusing on multiple benefits, NBS provide a series of benefits and support the handling of many global challenges. This information should be disseminated to at least all potential end users, which may be lead actors to adopt new NBS. However, training regarding emerging techniques is needed for planners, developers, and construction professionals to make things happen. Towards wide-spreading NBS knowledge, networking can be crucial too. Specifically, the participation in networks, associations, and consortiums, which are linked to NBS approach, may contribute to useful NBS knowledge acquisition.

Learn more
www.think-nature.eu



The ThinkNature project has received funding from the European Union's Horizon 2020 research and innovation programme under grant agreement No 730338

02

Purpose and main principles of NBS monitoring

NBS impact assessment best practices from EU H2020 projects

**What constitutes NBS monitoring?
How do I develop a robust NBS monitoring plan?
How can I execute monitoring and impact assessment activities?
What indicators of NBS impact can I use?
How do I select appropriate indicators of NBS impact?**

Why is it important to evaluate the impacts of NBS?

How can I ensure NBS work for Disaster Risk Reduction?

What kinds of NBS monitoring data can I gather, and how should I manage these data?

2 PRINCIPLES GUIDING NBS PERFORMANCE AND IMPACT EVALUATION

Coordinating Lead author
Skodra, J.

Lead authors
Connop, S., Tacnet, J.-M., Van Cauwenbergh, N.

Contributing authors
Almassy, D., Baldacchini, C., Basco Carrera, L., Caitana, B., Cardinali, M., Feliu, E., Garcia, I., Garcia-Blanco, G., Jones, L., Kraus, F., Mahmoud, I., Maia, S., Morello, E., Pérez Lapeña, B., Pinter, L., Porcu, F., Reichborn-Kjennerud, K., Ruangpan, L., Rutzinger, M., Vojinovic, Z.

Summary

What is this chapter about?

In this chapter, you will learn the main principles guiding NBS performance and impact evaluation. Good evaluation can be the basis for effective NBS implementation, enable evidence-based policymaking, support policy learning and facilitate flexible decision-making, via adaptive management, to ensure the sustainable performance of NBS over time. Credible and appropriate impact evaluation is based on scientific evidence and end-user experiences, is properly scaled and is linked to policy directives.



First, we explain key terms such as performance, impact, monitoring and evaluation (Section 2.1). Then, in Section 2.2, we describe the critical role of performance and impact evaluation in supporting decision-making. In section 2.3 we respond the question: "How do you develop a credible and appropriate impact evaluation?" We propose a set of general steps and principles necessary to develop an NBS impact monitoring and evaluation (M&E) plan, and explain how to tailor this plan to the specific type and size of an NBS in your local context. Finally, we synthesise the issues related to the design of M&E plans based on practitioners' feedback from existing H2020 projects and provide several examples.

How can I use this chapter in my work with NBS?

This chapter provides an overview of the general steps and principles that are necessary to develop a credible impact monitoring and evaluation plan. The challenges and knowledge gaps that may arise during the definition of a monitoring and evaluation strategy are also explored in this chapter.

When should I use this knowledge in my work with NBS?

Chapter 2 should be used at the beginning of the planning process for NBS monitoring and impact assessment. Timely planning enables allocation of the necessary time and resources to develop and implement the impact evaluation plan, identify potential data gaps, and address funding constraints. These principles can be revisited after initiating NBS monitoring to ensure that all relevant and applicable steps of the process are being deployed.

How does this chapter link with the other parts of the handbook?

Chapter 2 introduces practical steps and principles for impact evaluation of NBS measures in urban and rural settings. The individual impact monitoring steps are further elaborated in Chapter 3.

2.1 Introduction and definitions

Impact evaluation is part of a broader agenda of evidence-based policy-making and is essential to building knowledge about the effectiveness of interventions by highlighting what does and does not work to achieve desired change (Morton 2009). To achieve this, impact evaluation systematically and empirically examines the causal effects of the change in the built or natural environment associated with the NBS intervention. These effects can be grouped into 12 societal challenges³² and often impact simultaneously across multiple dimensions (e.g., Place regeneration and Health and Wellbeing). Thus, impact evaluation is related to the interpretation of indicators selected to assess NBS performance

³² Climate resilience, water management, natural and climate hazards, green space management, biodiversity enhancement, air quality, place regeneration, knowledge and social capacity building for sustainable urban transformation, participatory planning and governance, social justice and social cohesion, health and wellbeing, new economic opportunities and green jobs (see Chapter 4).

and effectiveness in addressing challenges and fulfilling objectives. The main aim of the impact evaluation is to answer a particular cause-and-effect question:

What is the impact (or causal effect) of an NBS intervention on an outcome of interest?

It is therefore essential to define in advance what impacts (or effects) an NBS intervention is expected to have, so that appropriate data at the appropriate scale (e.g., spatial and temporal) may be collected (Morton, 2009). Meaningful impact evaluation appropriately represents the NBS intervention in question and its context. It should be valid in all respects (e.g., providing for both internal and external validity³³) and provide useful information that can help inform future directions. In order to understand why aspects of an intervention worked or did not work, additional information on characteristics of NBS intervention are necessary to understand the reasons for effectiveness (Morton, 2009) and the conditions necessary for replicating the results in different context. In that sense, significant support from monitoring is essential to complement the impact evaluation.

The main characteristics of monitoring and evaluation are described in the following paragraphs to enable differentiation between different approaches suitable for NBS impact assessment.

Monitoring is a continuous process that tracks:

- The *implementation* process in order to determine what takes place and when, during a project. The collected data are used to inform project implementation, day-to-day management (adaptive management, management of risk) and decisions related to effective implementation processes and governance, and addressing challenges associated with these processes.
- *NBS performance* against expected results (related to 12 societal challenges³) and compared with measurements of a reference situation (baseline). NBS performance is defined as the degree to which NBS address an identified challenge³ and/or fulfil a specified objective in a specific place (territory), time and socio-economic context (Raymond et al., 2017). It measures:
 1. Change towards certain targets* (in this case performance thresholds must be set - targets bring an additional challenge relating to how they are selected /set); or ,
 2. The change in relation to the Baseline/Reference; or,
 3. A combination of numbers 1 and 2.

³³ Internal validity refers to study design (factors like selection bias, spillovers, etc. should be addressed) and external validity refers to generalizability (applicability of lessons-learned to another context or conditions)

Performance can be assessed by comparing against results from before the intervention, from different NBS interventions or from alternative non-NBS interventions, and may also analyse trends over time. The collected (qualitative and quantitative) data is used to assess Key Performance Indicators (KPIs) needed in impact evaluations.

Monitoring is therefore a critical source of information about NBS performance (e.g., in terms of effectiveness, see Figure 2-1), including implementation and costs, which supports the evidence base for both new and existing NBS. Monitoring is used to reflect the reference situation before/without NBS and the situation after/with the NBS implementation. In order to generate the most relevant data from this process, monitoring should be conducted at an appropriate scale taking into consideration urban morphology and regional characteristics. A range of stakeholders may be involved in the local monitoring teams, in different forms of participation - from informative to co-monitoring activities.

Establishing a common standard for key indicators is important for comparing NBS effectiveness across cities or regions. This helps to make results transferable and thus support decision-makers in demonstrably effective and evidence-based design of interventions in the built environment as well as in the natural environment.

Evaluation is periodic, objective (un-biased, well-documented) assessment of a planned, ongoing, or completed NBS project used selectively to answer specific questions related to design, implementation, and results. It should be conducted at the appropriate scale (e.g., spatial and temporal) according to different decision-making contexts. In general, evaluations can address three types of questions (Morra Imas and Rist, 2009):

- Descriptive questions explore what is taking place related to conditions, processes and stakeholder views;
- Normative rating questions assess 'what is' taking place in comparison to 'what should be' taking place and apply to inputs, activities and outputs;
- Cause-and-effect questions explore what difference the NBS intervention makes to outcomes.

Impact evaluation mostly addresses the cause-and-effect questions. The basic evaluation question - what is the causal effect (impact) of an NBS intervention on an outcome of interest? - can be applied to different contexts. For example, what is the impact of the NBS on the mitigation of the adverse effects of hydro-meteorological risks (that at the same time deliver socio-economic and well-being benefits)? What is the impact of the residents' participation in the NBS co-creation on the use of the NBS, social cohesion and human health and well-being aspects? How can broadening the scope of the evaluation of NBS projects engage diverse funding sources necessary for city-wide implementation of NBS?

In that sense, impact evaluation focuses on the attribution and causality. To be able to establish the causal effect and to attribute it to the NBS intervention

different methods can be used. These methods should estimate what the outcome would have been for the area and for its users (residents, people working in that area, etc.) if the NBS had not been developed (Morton, 2009). Alternatively, is a given NBS intervention effective compared to the absence of the intervention or to alternative, traditional engineering or planning solution? According to the causality view, **X** (NBS intervention) causes **Y** (an outcome, e.g., alters microclimate or social cohesion) and without **X**, **Y** would not exist.

Why are measurements needed in reference areas with no intervention?

Impact evaluation should use appropriate methods to prove that an NBS intervention (X), rather than other changes in environment, society, etc. - has caused a specific outcome (Y). However, NBS full development and changes in the built environment usually take a longer period of time, during which other factors may change as well. Thus, a whole range of effects can occur in the meantime, that may change the behaviour and perception of the population but have nothing to do with the original NBS intervention. This can be a global crisis (such as the Corona pandemic), but also local events (such as particularly mild weather for a longer period of time or a good score in sports events) that may change the feeling of happiness of the population independently of the original intervention.

One of the methods to filter out these effects, to prove the causality (Morton, 2009) and be able to attribute the outcome to the NBS intervention is a comparison³⁴ of the *treated area* (NBS implemented) with a *control area* that has not received a treatment (no NBS implemented). If an outcome of interest, e.g. microclimate or social cohesion, has improved in both areas it means that there were other factors that caused that change, rather than the NBS intervention. In cases where an outcome of interest, microclimate or social cohesion, has improved only in the treated area, then that change can be attributed to the NBS intervention.

Treated and control area are assessed before (pre) and after (post-) -the NBS intervention. The main challenge is to identify a control area and construct population group that is as similar as possible to the treated area/group and be in time before the participation and implementation process begins. In that sense, timely planning of impact evaluation will enable allocation of the necessary time and resources, and minimise funding constraints.

The definition of suitable "control area/group" or "before/after status" may not be applicable in all cases, for example, where NBS are designed to mitigate hydro-meteorological risks with relatively long (>10 years) return periods, such as floods and droughts (see Chapter 6). Under such a scenario, modelling could be an option, or evaluation of the impact of NBS on less severe (and more frequent) events.

³⁴ Example of a comparison to determine the impact of a programme or policy
<https://ec.europa.eu/jrc/en/research-topic/counterfactual-impact-evaluation>

For certain impact assessments of large-scale NBS, finding a suitable control area can be challenging. Ideally, the control area should have similar environmental and socio-economic conditions as the treated area but be located far enough to be unaffected by the NBS intervention (to avoid spillover effect). If no suitable control area can be identified, an alternative approach may be to predict what the situation would be in the project area without implementation of the NBS. This would become the reference situation to which post-NBS monitoring data could be compared to assess the impact of NBS.

2.1.1 The concept of effectiveness

NBS effectiveness is defined as:

the degree to which objectives are achieved and the extent to which targeted problems are solved. In contrast to efficiency, effectiveness is determined without reference to costs (Raymond et al., 2017, p. vi).

For example (based on Raymond et al., 2017):

- *Does the NBS lead to enhanced climate resilience in the urban area?*
- *Does the NBS lead to environmental benefits?*
- *Does the NBS lead to social benefits?*
- *Does the NBS lead to economic benefits?*
- *Does the NBS lead to biodiversity benefits?*

In cases when NBS interventions combine solutions to achieve different impacts, it is important to ensure that the impacts and its cumulative effects are integrated throughout the process rather than simply synthesised at the end (Morton 2009). This makes the whole analysis of their effects and impacts complex, increasing uncertainty with respect to data collection.

A functional analysis using safety and reliability analysis concepts (Figure 2-1) can help identifying the different system's components, their functions, their objectives and therefore their effectiveness. This methodology, classically used for technological systems is innovative and helpful to model the whole system and the interactions, as well as to break down the protected system into components with given functions. The concept of components' function and corresponding objectives identification is key to design and choose the best indicators for each application context. For example, a soakaway designed to divert road drainage can also be planted with shrubs and other plants to support pollinators. In that case, it is necessary to not only select indicators that measure the quantity of drainage waters diverted or extent of flooding avoided, but also indicators related to numbers of pollinators visiting flowers, etc. However, it is essential to avoid overlapping indicators in the projects' framework. Clustering of indicators can be handy for NBS effectiveness comparisons across cities or regions and help decision-makers to move towards better solutions.

Based on the project objectives the assessment of the performance and the effectiveness of a particular NBS intervention should take into account spatial and temporal scale as well as specific target groups. Important part of impact evaluations is an assessment of cost-benefit or cost-effectiveness. **Knowing which NBS interventions are effective and at what cost is crucial for informing decisions about whether an intervention could be scaled up and replicated.**

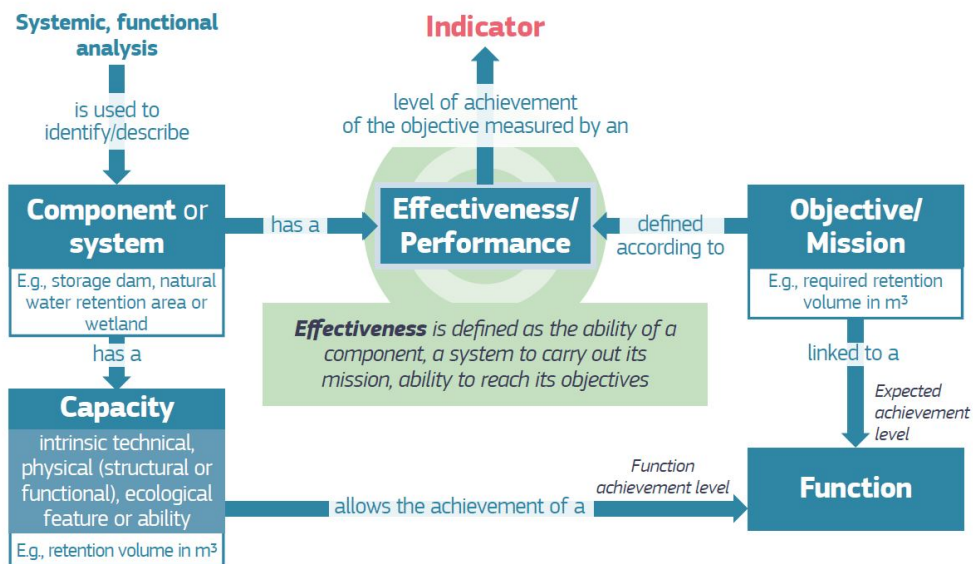

Figure 2-1. Effectiveness indicators are designed to measure the extent to which NBS capacity reaches the objective linked to an explicitly identified function (adapted from Tacnet et al., 2021)

Since benefits do not only refer to the physical sphere but include social/individual, economic, and ecological/environmental benefits as well, the complementary use of several evaluation approaches such as *ex ante simulations*, *mixed method analysis* (drawing on both qualitative and quantitative data), *modelling* and *process evaluations* can complement impact evaluations. It is therefore important to note that there are always alternative approaches to assess benefits, including those, which are non-monetisable. For a customised impact assessment, it may therefore be helpful to adapt methods to one another (e.g., by adding other dimensions to an already planned questionnaire) in order to arrive at an effective impact assessment. In addition, integrating assessment methods such as multi-criteria analysis or natural capital evaluation methods can be adopted.

2.2 Decision-making context and impact evaluations: from needs to indicators

This section provides a broad vision of decision-making contexts explaining why NBS impact evaluations are needed. The aim is to identify and describe the evaluation needs in general, independent of a specific project or objective.

Impact evaluation focuses on results of NBS interventions and provides a set of tools that stakeholders can use to verify and improve the quality, efficiency, and effectiveness of the interventions at various stages of implementation. Although impact evaluation is a core driver of decision-making, since it is resource (time and expertise) demanding it can remain a marginal activity. In that sense, *it is important that impact evaluation is designed at the early planning phases of an NBS intervention*, in order to allocate necessary resources, develop the stakeholder engagement strategy and, where possible, integrate citizen science in the design of the evaluation. Additionally, it is important that its value is thoroughly communicated in order to support appropriate mainstreaming and management.

In general, there are two main approaches to NBS impact evaluation:

1. NBS has already been developed in the past and the main aim is to determine whether the NBS intervention is effective (*retrospective impact evaluation, i.e., ex-post evaluation*). If NBS is already there and baseline data was not collected before the NBS was implemented, it is difficult to analyse whether the NBS is successfully implemented and whether the envisioned outcomes are achieved (challenges related to the selection of appropriate treated and control groups before the implementation). However, this can be done for specific indicators using data that was collected during the monitoring of the NBS and data collected for other purposes (e.g., regional statistics of city administration data).
2. NBS has to be chosen during the planning phase (in comparison to alternative solutions or business-as-usual, i.e., *ex-ante evaluation* including screening) and implemented. Impact evaluations are developed at the same time as the NBS intervention is being planned and are integrated into the NBS implementation (*prospective impact evaluation, i.e., ex-ante evaluation* including screening). Baseline data are collected before the NBS intervention is implemented for both the area and/or group receiving the intervention (the treated area/group) and the area/group used for comparison that is not receiving the intervention (the control area/group).

In both cases, the robust evidence generated by impact evaluations is important for greater accountability, innovation, and learning in a decision-making context. Learning and innovation demand a willingness to take risks and experiment. Interdisciplinary nature of impact evaluation can contribute to busting departmental silos and understanding broader benefits and co-benefits of NBS. The accountability is crucial when it comes to reporting to funders, influencing decision-makers and engaging novel funding streams (Gertler et al., 2016).

In that sense impact evaluations should provide credible evidence on performance of the NBS and on whether a particular NBS intervention has achieved or is achieving its envisioned outcomes. Impact evaluations require the interpretation of those indicators that have been chosen to assess the benefits and co-benefits over a period of time. In this respect, an important challenge is how to look at the different indicators as a whole, considering their variation at different time scales. It is also necessary to decide in advance how large an effect is desirable and establish thresholds of impact. This is required in order to design an evaluation with the appropriate degree of statistical power to be able to detect an effect of the size expected. However, it is important to avoid a situation whereby even a smallest change is interpreted as a success or failure of the NBS (Gertler et al., 2016).

The question concerning uncertainty and more generally information imperfection is very important here. Information imperfection (including uncertainty) can apply to data features (e.g., resolution, coverage/spatial extent, etc.) and come from type and reliability of sources (number of monitoring locations, experts) and also from the evaluation procedure, measurement method or model themselves. This is an important aspect as it carries the weight and reliability of recommendations that will come from the monitoring and evaluation work. In that sense, it is recommended to assess and propagate information quality during the process of evaluation. The risk of failure of the monitoring system requires the development of protocols to adopt mitigation measures in case a failure in the monitoring system is detected.

In the decision-making context, the ability to replicate results is fundamental to questions about the broader effectiveness and scalability of a particular NBS. In addition to assessing the effectiveness of NBS in terms of desirable outcomes, it is important to carefully trace a theory of change³⁵ that explains the process through which NBS intervention has achieved the final outcome (benefits, co-benefits, but also unintended negative effects). As illustrated in Figure 2-2, the process begins with determining the desired long-term impacts related to the project objectives/challenges (vision). Proceeding from the identification of the existing conditions (reality), the necessary inputs and outputs are identified to achieve short-term as well as intermediate outcomes, which themselves lead to the desired long-term impact (vision). Assumptions identify the locally specific risks and conditions that are present in the project's context and attempt to manage these risks by identifying what conditions must hold true for change to occur. Understanding the process through which the changes have been implemented enables the identification of causal pathways (Morton, 2009), explaining:

- how the development of NBS functions in producing outputs, and
- how the process of producing outputs influences the final outcome.

³⁵ A theory of change is a description of how an intervention is intended to deliver the desired results. It describes the causal logic of how and why a particular program or intervention will reach its intended outcomes. A theory of change is a key underpinning of any impact evaluation, given the cause-and-effect focus of the research (Gertler et al., 2016, p. 32).



Figure 2-2. Example of the Theory of Change (simplified adapted from The Young Foundation, CLEVER Cities project - D4.3/ WP4, pp. 18)

In order to gain a full picture of results, it is necessary to combine impact evaluations with monitoring and complementary evaluation approaches (i.e., to determine was the NBS implemented as planned, to provide context and explanations to quantitative analysis – qualitative data and mixed methods³⁶). Moreover, in the decision-making context a long-term, transdisciplinary studies that focus on comparisons between NBS and non-NBS alternatives are very valuable to policy-makers (Dick et al., 2020).

NBS are always implemented to fulfil a range of specified functions (e.g., reducing floods, reducing air temperature, etc.), which can relate either to a quantifiable parameters (e.g., water storage volume) or to a qualitative metric such as an index to assess the well-being of a population.

In practice, assessing NBS’ effectiveness can be seen as several decision-making problems:

- a) Choosing - what is the most effective NBS?
- b) Sorting - to which category of effectiveness or impact (low, medium, or high) does the NBS belong?
- c) Ranking - what is the effectiveness of NBS ranking from the worst to the best (or vice versa)?

Multi-criteria decision analysis (MCDA)³⁷ is a way to gather any kind of qualitative and quantitative criteria, which correspond to NBS impacts (Figure 2-3; see Langemeyer et al., 2020; Harrison et al., 2017).

³⁶ Mixed methods – an expert or a team of experts from different disciplines seeks to integrate quantitative and qualitative approaches to theory, data collection, data analysis and interpretation. The purpose is to strengthen the reliability of data, validity of the findings and recommendations, and to broaden and deepen our understanding of the processes through which program outcomes and impacts are achieved, and how these are affected by the local context. (Bamberger, 2012)

³⁷ [More information on multi-criteria decision analysis \(MCDA\)](#), PP.129-139

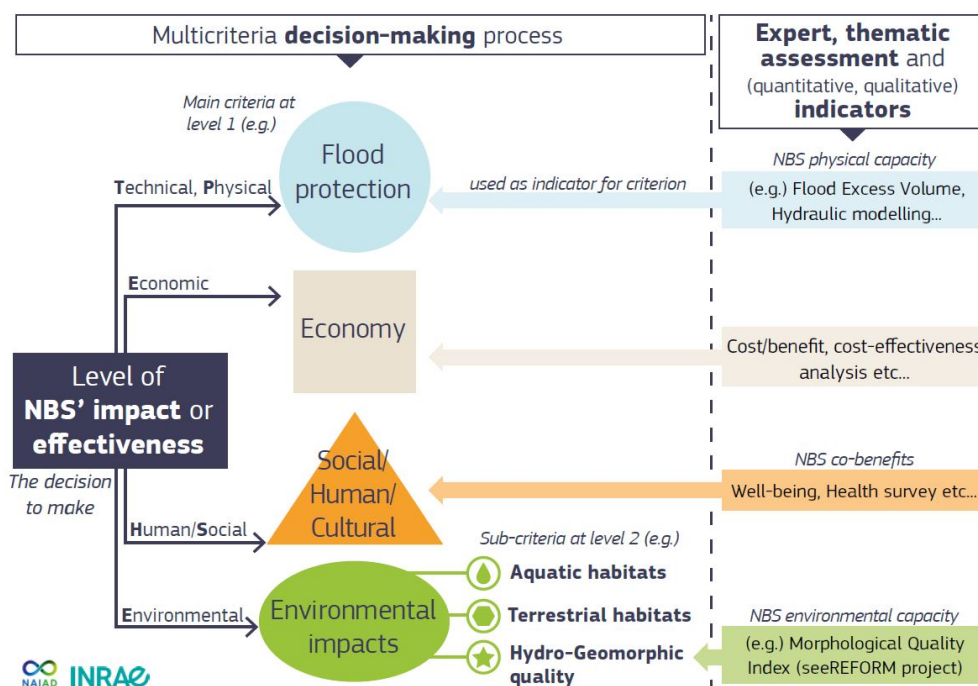

Figure 2-3. The analysis of the effectiveness or impact of NBS can be done through a combination of decision-aiding approaches and thematic, expert analysis and indicators. Features related to impact (effects) of NBS are combined in a multicriteria decision-making framework including technical (T), organisational (O) – not represented, physical (P), human (H), economic (E) and Environmental (E) considerations (TOPHEE framework) (Tacnet et al., 2021, based on the NAIAD project D5.4).

In practice, those criteria can be linked to measurable indicators coming from thematic, expert analysis. An interesting point is that it is a multidisciplinary framework, which can easily link deterministic, physical assessments and a global aggregated model as shown in Figure 2-3. In addition, this allows differentiation between factual, objective assessment and more subjective evaluation based on decision-makers' preferences.

Planning frameworks move proactively towards adaptive planning and management models, as a response to uncertainty and as an option to effectively harness resilience (adapted from IUCN, 2020³⁸). In this context, it is imperative that NBS implementation includes provisions to enable this adaptive planning and management, generating evidence-base provided by regular monitoring and evaluation, drawing on local knowledge as well as on scientific understanding. NBS effectiveness and continuous performance evaluation are relevant throughout the life-cycle of the intervention for identifying deviations, maximizing synergies and total impacts, assessing and mitigating potential trade-offs, and minimizing stranded investments.

³⁸ <https://www.iucn.org/theme/nature-based-solutions/resources/iucn-global-standard-nbs>

2.3 Principles for the development of impact monitoring and evaluation plans

Since evaluation plans are developed to evaluate benefits, co-benefits, and negative effects as well as to evaluate performance of NBS in achieving predefined objectives, this may require combining results of several impact evaluations (each requiring its individual impact evaluation plan). The first section lists general steps in designing and implementing an impact evaluation plan (Figure 2-4). The second section presents main principles that should be followed when developing steps of impact evaluations plans (Figure 2-4).

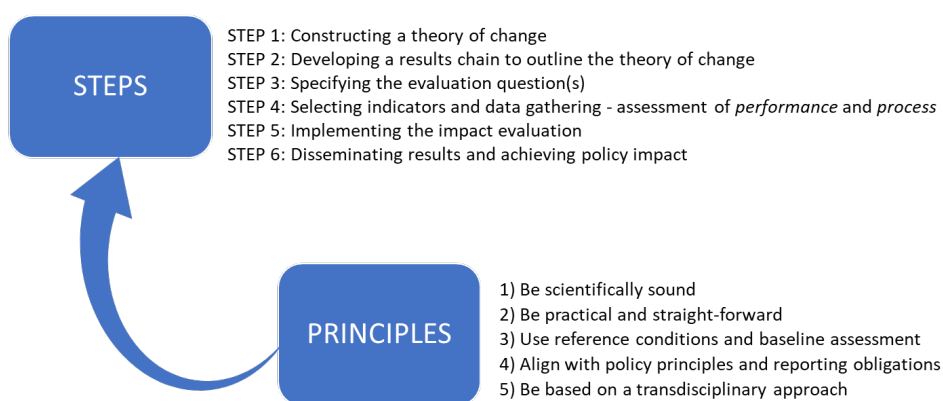

Figure 2-4. General steps and main principles involved in the development and implementation of an impact evaluation plan.

2.3.1 Steps

The design of an impact evaluation plan is a multi-faceted process. Based on the literature review and existing NBS projects we list six steps for developing impact monitoring and evaluation plans. This is a general overview that will be explained in more detail in Chapter 3.

STEP 1: Constructing and adopting a theory of change (Figure 2-2), which helps to identify objectives and challenges, as well as outlining the process for achieving the intended outcomes and impacts.

STEP 2: Developing a results chain to outline the theory of change – this covers both the implementation process and the results outcomes.

STEP 3: Specifying the evaluation question(s), the basic impact evaluation question is 'What is the impact (or causal effect) of an NBS intervention on an

outcome of interest?’ The focus is on the Impact - the changes directly attributable to an NBS intervention.

STEP 4: Selecting indicators and gathering data that answer the evaluation question(s) and that allow the assessment of *performance* and *process*: ‘Does NBS operate as designed and is it consistent with the planned theory of change?’ Critical selection of indicators that will be used to measure success/effectiveness of the NBS intervention, as well as cause-and-effect indicators should focus the evaluation, establish link to interventions well-defined objectives and assure that outcome is attributable to the NBS.

STEP 5: Implementing the impact evaluation, evaluating positive/negative features of NBS impacts related to the different challenges³⁹, analysing and interpreting the findings.

STEP 6: Disseminating results and achieving policy impact

2.3.2 Principles

A proper assessment and evaluation of the targeted impacts is needed in a way that is relevant and useful firstly to immediate end users and secondly to inform broader policy processes. Therefore, development of impact monitoring and evaluation plans should consider a few universal principles. Impact evaluation plans and its indicators must:

1. Be scientifically sound,
2. Be practical and straight-forward,
3. Use reference conditions and baseline assessment,
4. Align with policy principles and reporting obligations,
5. Be based on a transdisciplinary approach.

These principles are explained below. Examples of the implementation of these principles can be found in the selected NBS project example boxes between each chapter.

³⁹ In this Handbook impacts of nature-based solutions are assessed across 12 societal challenge areas: Climate Resilience; Water Management; Natural and Climate Hazards; Green Space Management; Biodiversity; Air Quality; Place Regeneration; Knowledge and Social Capacity Building for Sustainable Urban Transformation; Participatory Planning and Governance; Social Justice and Social Cohesion; Health and Well-being; New Economic Opportunities and Green Jobs – see Chapter 4

1) Impact evaluation should be scientifically sound

Since impact evaluations measure the change in an outcome that is attributable to a defined NBS intervention, it is based on models of cause-and-effect. It requires a credible and rigorously defined study design to control for factors other than the intervention. However, cause-effects are not necessarily the only model. In cases when the purpose of impact evaluation is raising awareness of the impact of the NBS, the crucial factor is engagement of communities and decision-makers. In that case, attribution may be replaced with contribution analysis⁴⁰. Ideally, in a Theory of Change, aspects such as 'community engagement' can also be assessed to demonstrate success of the project.

Measuring the impact of an NBS intervention should follow a concrete selection of appropriate methodology that is capable of assessing the Key Performance Indicators (or KPIs). Quantification and assessment of indicators is needed for every challenge (environmental, economic, social or other⁴). But how to select or develop indicators to be scientifically sound? This handbook provides an extended list of scientifically sound indicators (Chapter 4) and examples of their application (Chapter 5). The accompanying Appendix of Methods provides full descriptions of each indicator and provides a brief methodology for each.

In case further indicators are necessary, based on a scientific literature the following criteria can be used for their development (Figure 2-5):

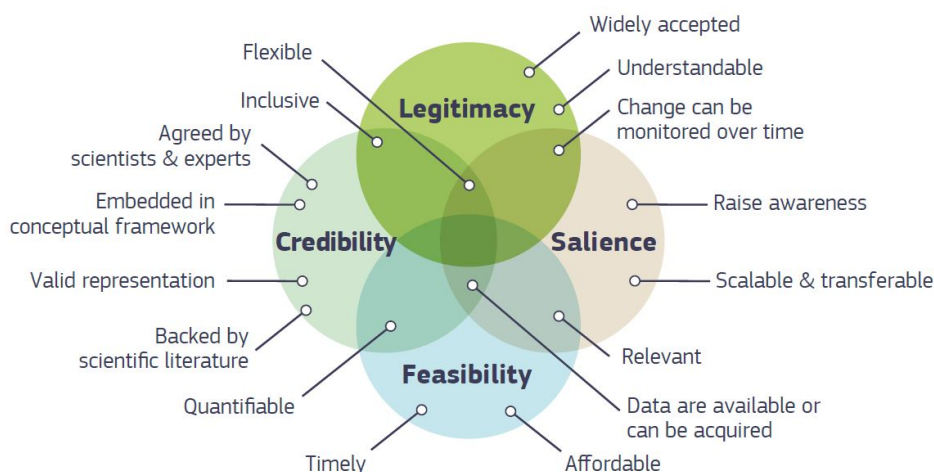

Figure 2-5. Criteria for developing ecosystem service indicators (adapted from Van Oudenhoven et al., 2018)

⁴⁰ Contribution Analysis is a structured approach that enables assessing real-world challenges. It consists of a step-wise, iterative process of refining Theory of Change. It does not seek to conclusively prove whether, or how far, a development intervention has contributed to a change. Instead it seeks to reduce uncertainty (<https://www.intrac.org/wpcms/wp-content/uploads/2017/01/Contribution-analysis.pdf>).

1. *Credibility*: the process of indicator development should be based on a review of existing literature and on an external review by experts, controlled path of production, elaboration, validation and monitoring of data according to scientific protocols and methodologies: scientific selection methods, validation, integration into methodology, triangulation of data.
2. *Saliency*: relates to the capacity of indicators to convey useful and relevant information for decision makers about specific objectives as perceived by potential end-users and stakeholders. It is important to use effective means to present and translate scientific indicators in a way that it is easy to communicate to non-experts: easy to read, understandable and not generating misunderstanding (visualisation, modelling and simulation tools: such as graphical, GIS, tabular, model animations, landscape design drawings, etc.). Indicators should be temporary explicit to have the potential to monitor change and assess progress over time. Moreover, indicators should be scalable and transferable.
3. *Legitimacy*: selection on the basis of relevant indicators to meet the scopes of monitoring process (for example, SMART⁴¹): the selection of the most appropriate model of impact evaluation will depend mainly on vision and outcomes of interest in the project, scale of implementation, desired co-benefits and available resources allocated to monitoring work and time. The impact monitoring and evaluation plans need to be iterated and co-produced with the relevant stakeholders and experts from different disciplines (see principle 5 on transdisciplinarity) and not be a one-way communication or design. In addition, indicators should be the outcome of a shared process, to meet the expectations of a wide number of stakeholders and, where possible, to express the engagement of communities in decision-making and raise the awareness.
4. *Feasibility*: relates to the sufficiency of data, time and resources to assess and monitor indicators (simple indicators are easy to acquire, easy to elaborate, assess, and monitor over time). Another crucial aspect to the scientific appropriateness of impact evaluation models is checking beforehand the availability of baseline data, as well as, the (economic, temporal, ethical) feasibility of measuring new data or collecting new information throughout the monitoring process to get down the road.

2) Impact evaluation should be practical and straightforward but fulfil technical requirements

Impact evaluation has to be practical and straightforward, including when planned by scientists and conducted by experts. This implies that many barriers should be overcome in communicating (and making aware of) the final aim of the monitoring activity, to assure it is successful and well conducted.

⁴¹ SMART Specific, Measurable, Attributable, Realistic, and Timely or Time-bound, see Chapter 3

Since every NBS project is unique, measuring of impact/outcome needs to be adjusted to that specific project and context. Although no universal framework can be proposed, some basic requirements for a successful monitoring activity are listed below.

- A high level, cooperative dialogue among practitioners, local or regional authorities, stakeholders and scientists should occur from the beginning of developing the monitoring and impact evaluation plans (see point 5) on transdisciplinarity)

This will help practitioners, local or regional authorities and stakeholders to be more aware about the critical aspects of a scientifically robust assessment, as well as help scientists to focus more on the challenges that really need to be tackled by the NBS intervention.

- Definition of the scope in which effects of the intervention are expected
- Definition of the site of investigation and/or target groups

The site of investigation can be the NBS site, its neighbourhood, its district, the whole city or region. The target group is located within this spatial limit and it should be as statistically representative as possible (see Chapter 3 and Chapter 7).

- Choice of a control area/group (when applicable)

In many cases outside factors may influence outcome of the NBS intervention. In order to validate the monitoring results and correlate them with the NBS intervention realized, a parallel, twin, monitoring activity should be performed elsewhere, by identifying the so-called "control area/group". It should be as identical as possible to the actual treated area/group. This usually means that it should be located in the same neighbourhood/district/city/region (depending on the scale at which effects are expected, by scaling a level up the spatial scale) in order to take local conditions (e.g., climatic conditions or cultural ones) into account. For instance: if NBS effects are expected at the district level, the control area/group should be chosen within the same city or region but in a different district.

- Choice of a reliable and feasible frequency of data collection

Reliable frequency of the data collection should ensure the impact evaluation on a temporal scale, which is adapted to the type of intervention and/or of the challenge to be faced. However, data collection frequency should be also feasible (see Figure 2-5), since regional authorities, municipalities or stakeholders generally have limited budget/persons to do this.

3) Impact evaluations should clearly state and use reference conditions and baseline assessment

Baseline data are important for measuring pre-intervention outcomes (reference conditions) that are used later in the assessment process for the before-and-after comparison. Chapter 7 of this handbook discusses how baseline data are established and used operationally. In this section we list the following key points:

- Ensure that the method for establishing baseline data is repeatable
- Differentiate between process and outcome
- Chose standardized ways of assessing certain outcomes to allow for the accumulation of evidence and comparability; striking a balance between common indicators and highly specific ones;
- Assure clear link between challenges addressed and indicators selected
- Establish baseline and control area/group or reference values for comparison in order to determine change(s) attributable to NBS implementation

4) Impact evaluation should align with policy principles and reporting obligations.

The expected outcomes based on objectives of an NBS intervention are important for the impact evaluation. However, it is also important to identify and include unexpected outcomes. Considering the time-frame of the project and the time necessary for outcomes to be 'visible', some impacts may occur more quickly than others.

In that sense, short-term immediately visible improvements are initial outcomes that can be assessed immediately after the intervention (green quality, aesthetic, amenities, etc.). Intermediate outcomes are assessable after some period of time during the project (use and function of NBS, individual status and perception, social environment) while long-term health outcomes (mortality rates, life expectancy, cardiovascular disease, obesity, etc.) are often difficult to assess; either because there is no long-term monitoring institutionalized, but also because these outcomes are influenced by many interweaving factors. Moreover, achieved positive impacts might change over time (depending on management, succession, changing climate, etc.).

To assure relevance for policy-makers, it is also important to seek alignment with key policy objectives. This can be done through a strategic review of policy alignment between local/regional/national strategic objectives and potential NBS benefits. The desired impact from the NBS implementation process can then feed into the local administration, urban or regional policies (e.g., green roofs mitigation and adaptation measure).

This should also provide connection to the local, national and EU-based policies and requirements. For example, NATURA 2000 may require from all member states to use certain indicators in the assessment of their natural areas. Similarly,

Floods Directive will specify those indicators that are related to flood risk assessment. Water Framework Directive demands certain water quality standards and indicators. Similarly, the LIFE programme⁴², the EU's funding instrument for the environment and climate action, has developed a KPI framework that can be seen as embedding element for measuring the impact of a NBS. However, indicators in this Handbook (Chapter 4) are based on H2020 Projects involving EU and non-EU cities and regions and are thus applicable globally.

5) Impact evaluation should be based on a transdisciplinary⁴³ approach.

Impact evaluation of NBS interventions relates to a whole range of different societal challenges. It is unlikely that the knowledge required for such broad evaluation sits with a single individual. As such, monitoring and evaluation teams should engage societal actors and experts from across relevant disciplines in a transdisciplinary approach. A transdisciplinary approach enables combining knowledge from societal actors with knowledge and methods from different disciplines (e.g., engineering, public health, social sciences, etc.) (Schneider et al., 2019). To achieve transdisciplinarity, monitoring and evaluation plans should be co-produced in collaborative actions to achieve the best balance between local needs, values and knowledge, and scientific interdisciplinary knowledge and requirements. Local authorities and practitioners, who are aware of real conditions as well as administrative and technical barriers, should drive collaborative actions. However, they should also involve additional expertise, for example from the civic sector (to identify local needs and raise the awareness about the benefits related to NBS), industry (to contribute to feasibility), and scientists.

The co-production process should start with identifying a joint vision (Theory of Change, Figure 2-2) and establishing desired outcomes collaboratively from the beginning. By approaching co-production this way, it will be easier to relate outcomes to the planned NBS, to expected results, and to the indicators that will be used to measure the expected impact. Support from the local community is crucial as this not only improves the quality of information and trust in the results of the impact evaluation itself, but also raises awareness and increases sense of stewardship and caring. Likewise, partnerships and collaborations among actors that are normally not in contact with each other can be generated. Allowing different partners to get involved in participatory decision-making will generate a sense of ownership of the solutions to be implemented (see also Mahmoud and Morello, 2021). Their involvement will bring diverse perspectives in defining outcomes, selecting indicators, collecting and analysing data.

Support from the scientific community or other experts is desirable when deciding what methods or research designs will be considered credible for the impact evaluation. This handbook is already driven by scientific principles and should

⁴² [The LIFE Programme](#)

⁴³ Transdisciplinarity – problem-driven, cross-disciplinary, cooperative approach including scientists, practitioners, stakeholders.

facilitate selection of suitable monitoring tools and protocols that can be adapted to the local needs.

In that sense, it would be desirable that local administrations and practitioners in collaboration with stakeholders and scientists interested in the implementation and monitoring of a NBS:

- Tailor the monitoring protocols, while preserving the scientific robustness;
- Choose the needed experimental setup according to the required resolution and disciplines; and,
- Follow up regarding the process during short and long-terms implementation processes.

2.4 Capitalising on existing experiences and remaining critical concerns

Impact evaluation of NBS interventions requires joint effort of different actors to be able to assess wide range of outcomes and identify trade-offs before, during and after the NBS implementation. A high-quality impact evaluation depends on skills of team members conducting the study. However, even with a skilled team, evaluation processes may face different challenges. In the following sections, we describe challenges and gaps from H2020 projects and conclude with key messages based on existing experiences from these projects.

2.4.1 Challenges and gaps in current monitoring and evaluation efforts

Impact evaluation is related to the interpretation of indicators selected to assess NBS performance and effectiveness in addressing challenges and fulfilling objectives. A number of common challenges and gaps in monitoring and evaluation efforts are emerging from the existing NBS projects. These challenges are analysed from four perspectives: practitioner, scientific, citizen/user and private sector.

From a practitioner perspective main challenges are identified from project work with stakeholders in cities and regions. They include a lack of expertise in evaluation and data collection, in the critical selection of indicators that address the predefined impacts; short time frames; dispersed and siloed data within different agencies; lack of implementation monitoring vs. performance monitoring (which could lead to the missing of important data afterwards, such as for the accounting of the cost-benefit and cost-effectiveness); etc. Problems of dispersed and siloed data can partly be solved with transdisciplinary approach, which enables the effective gathering of data from many different disciplines (health, air quality, biodiversity, water management, economics, etc.) and effective communication with those who hold those data.

The use of indicators themselves has following practical issues:

- Indicators exist but it is difficult to use them due to the lack of understanding (e.g., understanding the logic behind the models), data unavailability, data not available for use at fine scale (e.g., detailed census data may be available at household level but cannot be released), etc.
- Lack of resources, lack of ownership, lack of requirement from funders, lack of interest once NBS has been installed, lack of expertise, change in personnel
- Issues related to the complexity of cities and regions, as a system of systems with several layers of networks constantly interacting with each other, which makes it difficult to identify causal chains (especially when people and their behaviour are the target of interest)
- The multiplicity of decision-making contexts and processes cannot be captured by a universal and versatile set of indicators: each decision requires the selection of ad-hoc indicators from among an extended set. Formalisation of all those decisions is not always fully understood by the different stakeholders who may expect easy ready-to-use methods working in any conditions.
- Feasibility based on the available expertise (e.g., biomonitoring).

From a scientific perspective, (see section 2.3.2) the main gaps in the monitoring process are:

- Lack of differentiation between the process and outcome, the gaps in the monitoring methodology and implementation stages (micro-, meso-, macro-, etc. scales of interventions) and longer-time frame of effects measurement.
- Lack of longer-term evaluations to assess effects over time and guaranteeing continuity of monitoring measurements: often models of monitoring impacts lack the continuity of measurement from the pre-greening to the long-term effects in the post-greening phase, they are also influenced by the complexity and feasibility of the monitoring itself. The ideal impact monitoring methodologies are the ones with the minimum specialised equipment and time efforts, or relying on ready-to-run and consolidated data acquisition protocols, possibly managed by the public authority. Involving citizens and local stakeholders in the co-monitoring of NBS interventions, often requires simplification, which is challenging for some complex impacts.
- Difficulties in communicating to non-scientific partners in a less -technical language. Engaging stakeholders in the process of data collection and monitoring is challenging. However, scientists should translate indicators to be simple and capable of immediate representation, easy to understand and, connected to people's priority interests and concerns.

- Ability to express levels of uncertainty associated with evaluation outcomes. Decision-makers want to know what is the relative level of certainty or uncertainty associated with evaluation work. For example, speaking in practical terms, if the likely chance of an NBS achieving its intended impact is 80% then decision-makers may be very willing to up-scale such an NBS intervention elsewhere, as opposed to their willingness to up-scale if the likelihood of achieving the desired impact is only 20%.
- Indicators exist but they may not be relevant to the studied NBS in a place-based context. The way indicators are assessed (quantitative, qualitative, traceability/justification of hypothesis) is essential.
- Any set of indicators will always remain contextual and correspond to the knowledge level at a given moment: it is therefore interesting to provide lists of indicators but also methodologies to build new ones in a dynamic way if needed.
- Measurability of intangible impacts (e.g., aesthetic enjoyment) and spillovers (impact of NBS intervention may spread beyond the treated area or group) as well as accounting for trade-offs is challenging, particularly because of the diverse perspectives of stakeholder valuing NBS, the multiple time scales of assessment and influence of other programs and factors.
- The assessment of NBS effectiveness or impacts is a multi-scale and multi-temporal problem. Indicators for urban scales and issues may not be relevant for wider scale such as catchment basin scale for example when dealing with flood risk reduction.
- Indicators related to NBS effectiveness require the use of multi-disciplinary approaches able to combine physical, environmental, social, human and economic features. New paradigms are needed to integrate this different kind of knowledge and related methods.

From citizens/users perspective: experience with citizen monitoring is limited and collected data about the impacts of NBS is often not presented in a user-friendly format and/or made available to the public. Need for scientific and intercultural translation, lack of appropriation and adequate tools for co-diagnostic, co-evaluation and co-monitoring that involve citizens as active actors in the evaluation processes. Adoption of tools that include: the perception of citizens, the translation and adaptation of content, the validation of monitoring results by citizens. To consider people's voices, is to recognize the plurality and open paths for effective co-production of knowledge, see section 2.3.2.

From a private sector perspective: in some cases, NBS are elaborated in collaboration with industries and partners from the private sector. This is particularly true when the NBS implementation includes regeneration of previously productive sites and/or includes the implementation of innovation technologies. In all these cases, to have valuable inputs, beyond the non-monetisable benefits, is a real challenge.

In addition to the four perspectives, we identify three types of issues in NBS implementation of monitoring and evaluation plans: technical, physical and social. Some NBS which have been selected through the previous steps of building a theory of change and which encompass an evaluation model (e.g., SMART) have encountered a variety of hindrances in their actual implementation contexts, such as:

- Technical issues: some NBS in place require a specific sophisticated technical knowledge that is not necessarily available in project competences.
- Physical issues: some NBS in place have shown physical constraints or drawbacks that might obstruct the implementation in reality or induce unexpected side effects (e.g., a riparian forest causing woody debris and bridges' section reduction or even closure, see NAIAD project, La Brague demonstration site).
- Social issues: a social acceptance factor towards implementation is needed for any NBS impact model evaluation to measure an increase in openness, awareness, citizen engagement and to assess management efficiency, accountability, sharing, transparency, and communication. That is why a transdisciplinary approach is needed in order to facilitate the co-production of monitoring and evaluation plans with stakeholders.

In these cases, where the foreseen monitoring and evaluation plans cannot be implemented, mitigation measures have to be applied.

2.4.2 Key messages from existing projects

NBS performance and impact evaluations should provide answers to policy questions that affect people's daily lives. In H2020 projects questions such as 'Does an NBS intervention influence air quality, enable climate adaptation, regulate microclimate, increase biodiversity or contribute to social cohesion and well-being?' are related to societal challenges. Key messages from these projects are listed below.

Three core elements of well-designed NBS performance and impact evaluation are:

1. A concrete assessment *question* related to an outcome of interest developed in a theory of change that can be answered with the impact evaluation.
2. A robust *methodology* that balances understanding of the complexity of diverse NBS outcomes, as well as trade-offs, with feasibility in relation to the specific socio-economic context and available resources.
3. A well-formed evaluation *team* that functions as a transdisciplinary partnership between different sectors (public, private, civil society) and various knowledge disciplines depending on the type of NBS and outcomes of interest.

It is important to have a practical focus and adapt these very general steps and principles to local context and develop tailor-made monitoring and evaluation plans. Moreover, don't be afraid to start small and begin with evaluation indicators that are more manageable and understandable. This can represent a good foundation for the development of a transdisciplinary evaluation plan.

When developing such bespoke plans, although local practitioners and the local population are crucial for plan development, it is also necessary to engage experts from different disciplines to ensure that various benefits and co-benefits as well as unintended negative effects of NBS interventions are assessed and evaluated. Although impact evaluations are complex processes with dynamic parts, they are a worthwhile investment and collaboration can be the most effective way to maximise the return on this investment.

Participants in the NBS impact evaluation should be included in the dissemination efforts. Since they have invested their time and energy in planning and implementing monitoring and evaluation plans, it is essential to ensure that they have access to and remain informed about the evaluation results. This small effort can contribute to their continued interest and willingness to participate in future NBS evaluations.

On the following pages and between chapters there are different case studies illustrating main characteristics and challenges of monitoring and evaluation plans from different H2020 projects. Chapter 3 explains step-by-step the process of development of monitoring and evaluation plans, which complements the general overview provided in this chapter.

2.5 References

- Baldacchini, C., Sgrigna, G., Clarke, W., Tallis, M., and Calfapietra, C., 'An ultra-spatially resolved method to quali-quantitative monitor particulate matter in urban environment', *Environmental Science and Pollution Research*, Vol. 26, 2019, pp. 18719–18729.
- Bamberger, M., 'Introduction to Mixed Methods in Impact Evaluation', *Impact Evaluation Notes*, No 3, 2012. Available from: <https://www.interaction.org/wp-content/uploads/2019/03/Mixed-Methods-in-Impact-Evaluation-English.pdf>
- CLEVER Cities project, *D4.3 Monitoring strategy in the FR interventions*, 2020. Available from: https://clevercities.eu/fileadmin/user_upload/Resources/CLEVER_D4.3_Monitoring_Strategy_in_the_FR_interventions_vF2.pdf
- Dick, J., Carruthers-Jones, J., Carver, S., Dobel, A.J., and Miller, J.D., 'How are nature-based solutions contributing to priority societal challenges surrounding human well-being in the United Kingdom: a systematic map', *Environmental Evidence*, Vol. 9, 2020, pp. 1–21.
- Dick, J., Miller, J.D., Carruthers-Jones, J., Dobel, A.J., Carver, S., Garbutt, A., Hester, A., Hails, R., Magreehan, V., and Quinn, M., 'How are nature based solutions contributing to priority societal challenges surrounding human well-being in the United Kingdom: A systematic map protocol', *Environmental Evidence*, Vol. 8, 2019, pp. 1–11.
- Funnell, S. and Rogers, P., *Purposeful Program Theory: Effective Use of Theories of Change and Logic Models*, Jossey-Bass/Wiley, San Francisco, 2011.
- Gertler, P.J., Martinez, S., Premand, P., Rawlings, L.B., and Vermeersch, C.M., *Impact evaluation in Practice*, Second Edition, Inter-American Development Bank and World Bank, Washington, DC, 2016. Available from: <https://www.worldbank.org/en/programs/sief-trust-fund/publication/impact-evaluation-in-practice>

- Harrison, P.A., Dunford, R., Barton, D.N., Kelemen, E., Martín-López, B., Norton, L., Termansen, M., Saaikoski, H., Hendriks, K., Gómez-Baggethun, E., Czúcz, B., García-Llorente, M., Howard, D., Jacobs, S., Karlsen, M., Kopperoinen, L., Madsen, A., Rusch, G., van Eupen, M., Verweij, P., Smith, R., Tuomasjukka, D., and Zulian, G., 'Selecting methods for ecosystem service assessment: A decision tree approach', *Ecosystem Services*, Vol. 29, 2018, pp. 481–498.
- Langemeyer, J., Wedgwood, D., McPhearson, T., Baró, F., Madsen, A.L. and Barton, D.N., 'Creating urban green infrastructure where it is needed – A spatial ecosystem service-based decision analysis of green roofs in Barcelona', *Science of The Total Environment*, Vol. 707, 2020, 135487.
- Mahmoud, I. and Morello, E., 'Co-creation Pathway for Urban Nature-Based Solutions: Testing a Shared-Governance Approach in Three Cities and Nine Action Labs', *Smart and Sustainable Planning for Cities and Regions*, Springer International Publishing, 2021, pp. 259–276.
- Morra Imas, L.G. and Rist, R., *The Road to Results: Designing and Conducting Effective Development Evaluations*, World Bank, 2009.
- Morton, M.H., *Applicability of Impact Evaluation to Cohesion Policy, Report Working Paper*, 2009. Available from: https://ec.europa.eu/regional_policy/archive/policy/future/pdf/4_morton_final-formatted.pdf
- Pintér, L., Hardi, P., Martinuzzi, A., and Hall, J., 'Bellagio STAMP: Principles for sustainability assessment and measurement', *Ecological Indicators*, Vol. 17, 2012, pp. 20-28.
- ProGIreg, *Methodology on spatial analysis in front-runner and follower cities*, 2018. Available from: <https://progireg.eu/resources/planning-implementing-nbs/>
- Raymond, C.M., Berry, P., Breil, M., Nita, M.R., Kabisch, N., de Bel, M., Enzi, V., Frantzeskaki, N., Geneletti, D., Cardinaletti, M., Lovinger, L., Basnou, C., Monteiro, A., Robrecht, H., Sgrigna, G., Munari, L. and Calfapietra, C., *An Impact Evaluation Framework to Support Planning and Evaluation of Nature-based Solutions Projects, An EKLIPSE Expert Working Group report*, Centre for Ecology and Hydrology, Wallingford, 2017.
- Rogers, P.J., 'Matching Impact Evaluation Design to the Nature of the Intervention and the Purpose of the Evaluation', *Journal of Development Effectiveness*, Vol. 1, No 3, 2009, pp. 217- 226.
- Schneider, F., Giger, M., Harari, N., Moser, S., Oberlack, C., Providoli, I., Schmid, L., Tribaldos, T. and Zimmermann, A., 'Transdisciplinary co-production of knowledge and sustainability transformations: Three generic mechanisms of impact generation', *Environmental Science and Policy*, Vol. 102, 2019, pp. 26-35.
- Tacnet, J.-M., Piton, G., Favier, P., Pengal, P., Curt, C., Yordanova, R., Van Cauwenbergh, N., Giordano, R., *Natural Based Solutions choice and effectiveness assessment: Integrative modelling and decision-aiding framework*, Editions Quae, Versailles, 2021 (submitted).
- van Oudenhoven, A.P., Schröter, M., Drakou, E.G., Geijzendorffer, I.R., Jacobs, S., van Bodegom, P.M., Chazee, L., Czúcz, B., Grunewald, K., Lillebø, A.I., Mononen, L., Nogueira, A.J.A., Pacheco-Romero, M., Perennou, C., Remme, R.P., Rova, S., Sybre, R.-U., Tratalos, J.A., Vallejos, M., and Albert, C., 'Key criteria for developing ecosystem service indicators to inform decision making', *Ecological Indicators*, Vol. 95, No 1, 2018, pp. 417-426.
- White, S. and Pettit, J., 'Participatory Methods and the Measurement of Wellbeing', *Participatory Learning and Action*, Vol. 50, 2004, pp. 88-96.

**Drawing on knowledge from projects
funded by the European Union**

CONNECTING NATURE

Bringing cities to life, bringing life into cities

Genk (BE) Glasgow (GB) Poznań (PL) A Coruña (ES) Burgas (BG)

Ioannina (GR) Málaga (ES) Nicosia (CY) Pavlos Melas (GR) Sarajevo (BA)

Brings in actions to feed the initiation and expansion of economic and social enterprises in production and large-scale implementation of NBS in urban settings to measure the impact of these initiatives on climate change adaptation, health and well-being, social cohesion and sustainable economic development.

Approach to Impact Assessment

The project developed indicators working co-creatively with our Front-runner cities. The goals behind both past and planned NBS projects, and the associated benefits and co-benefits delivered were explored. These criteria were used to filter a comprehensive list of indicators to identify which were recommended 'core' (i.e., had key relevance for all cities across all NBS), and which were additional 'feature' (i.e., had potential relevance, but were more specific to individual NBS). The results were sense-checked with the city teams, and then different options were developed for implementing each indicator dependent upon the expertise and capacity within each city. The indicators were implemented in the cities, to ensure that a diverse evidence base of benefits is available to unlock broader funding and secure political buy-in.

Involved Stakeholders and roles

The stakeholders involved in the Connecting Nature NBS impact assessment process were the following:

- City planners and officers: they were in charge of detailing the NBS, as well as participating in the adaptation of the indicators to their cities. They were also the link to local organizations and communities for data collection.
- Science-practice partners: academics belonging to universities, who guided cities through the steps of the NBS impact assessment process. The collaboration was established through periodic meetings where the evaluation and monitoring plans for each city were developed.
- Consultant companies and SMEs: they had the function of interface with the cities to locate the stored knowledge of the NBS, and co-produce NBS catalogues and monitoring tools.

Municipal Administrations (FR/FL)

Planning experts

Scientists / Academia

Schools and kindergartens

Consultant Companies and SMEs

Main Challenges addressed

1. Climate Resilience

2. Water Management

3. Natural and Climate Hazards

4. Green Space Management

5. Biodiversity

6. Air Quality

7. Place Regeneration

8. Knowledge and Social Capacity Building

9. Participatory Planning and Governance

10. Social Justice and Social Cohesion

11. Health and Wellbeing

12. New Economic Opportunities & Green Jobs

Lessons learned

A key challenge has been the diversity of expertise within the city teams in relation to evaluation indicators. Some cities had little evaluation expertise in the area of nature-based solutions, while for others expertise in one area such as environmental indicators existed, but it was either housed in a different department or was provided by a university partner. One of the main lessons we all learned was how working co-productively with local teams, through regular meetings and mutual agreements for each of the impact assessment steps. In this way, training activities were carried out for cities in evaluation and monitoring competencies, but in addition, the importance of the impact assessment process was also explained and emphasized. As the local teams became empowered to design their NBS monitoring and evaluation plans, they increased their efforts aimed at understanding the real impact of their urban interventions.

Learn more

<https://connectingnature.eu/>



Grow Green

Manchester (GB) Valencia (ES) Wroclaw (PL)

Brest (FR) Modena (IT) Zadar (HR) Wuhan (CN)

The project aims to accelerate the delivery of NBS strategies across Cities. By investing in NBS pilot projects in Manchester, Valencia and Wroclaw that deliver quantified improvements in climate and water resilience, social, environmental and economic performance, the project will develop a robust evidence base and a replicable approach that will enable this acceleration across Europe and the rest of the world.



Drawing on knowlegde from projects funded by the European Union

SCOPE A partnership for greener cities to increase liveability, sustainability and business opportunities

Approach to Impact Assessment

The impact assessment will be undertaken at two different levels. At a city level the impact of each pilot project will be evaluated in terms of evidence-based outcomes, key messages and lessons learned.

A thematic evaluation of specific NBS interventions will also be undertaken based on the Eklipse framework challenges of climate resilience, water management, green space management, bio diversity, air quality, social justice and social cohesion, health and wellbeing, economic opportunities and green jobs.

Involved Stakeholders and roles

The stakeholders involved for the monitoring process provides a rich co monitoring opportunities: Civil society – citizens and representatives of active associations, private sector, Academia policy makers and public sector/associated service stakeholders. Nevertheless the degree of engagement and interaction of each type of stakeholders depends on the cities' requirements and culture about participation.

Municipal Administrations

Regional/national statistics authority

Citizen

Planning experts

Scientists / Academia

NGOs

Schools and kindergartens

Main Challenges addressed

1. Climate Resilience

2. Water Management

3. Natural and Climate Hazards

4. Green Space Management

5. Biodiversity

6. Air Quality

7. Place Regeneration

8. Knowledge and Social Capacity Building

9. Participatory Planning and Governance

10. Social Justice and Social Cohesion

11. Health and Wellbeing

12. New Economic Opportunities & Green Jobs

Lessons learned

The EKLIPSE framework is the basis for the KPIs identification but to assure the alignment of the monitoring strategy with the expected outcomes, local stakeholders must be integrated in the process since the beginning.

Climate related variables has specific conditioning for monitoring due to scale (space and time domains) that must be considered to plan the monitoring strategy. For some KPIs or variables modelling could offer a rich information to fill some monitoring GAPS or to avoid uncertainty.

Learn more
www.growgreenproject.eu/



The GROWGREEN project has received funding from the European Union's Horizon 2020 research and innovation programme under grant agreement No 730283

UNaLab

Urban Nature Labs

Eindhoven (NL)

Tampere (FI)

Genoa (IT)

Stavanger (NO)

Prague (CZ)

Castellón (ES)

Cannes (FR)

Başakşehir (TR)

Hong Kong (CN)

Buenos Aires (BR)

UNaLab is generating evidence of the benefits, cost-effectiveness, economic viability and replicability of NBS targeting climate change mitigation and adaptation, and sustainable water management. UNaLab activities promote smart, inclusive, resilient and sustainable urban communities through stakeholder co-creation of Urban Living Labs (ULLs) and local NBS demonstrations, and co-evaluation of NBS impact. Collaborative knowledge production among the network of UNaLab partner cities yields project results that reflect diverse urban socio-economic realities, along with differences in the size and density of urban populations, local ecosystem characteristics and climate conditions. UNaLab project outcomes that support further replication and up-scaling of NBS include an ULL model, ICT tools for NBS co-creation and co-monitoring, applicable business and financing models, and guidance on governance-related structures and processes to support NBS uptake.



Drawing on knowledge from projects funded by the European Union

Image: Vuores Central Park, Tampere – Photo © City of Tampere

Approach to Impact Assessment

UNaLab uses a highly participatory approach to produce evidence of NBS impact, including co-creation, co-development, and co-monitoring activities. The impact assessment of the NBS in the UNaLab front-runner cities first involved iterative co-definition of Key Performance Indicators (KPIs) and Key Impact Indicators (KIIs) with a wide range of stakeholders. The UNaLab front-runner cities then iteratively co-developed robust monitoring and evaluation strategies together with project partners and other technical experts to thoroughly assess NBS performance and impacts in a cost-effective way. The ICT platform and NBS monitoring and evaluation tools developed by UNaLab project partners support long-term NBS evaluation by enabling the automated collection of monitoring data for NBS impact assessment from IoT sensors wherever possible, while allowing manual entry of data as needed.

Involved Stakeholders and roles

Stakeholders played a critical role in developing and shaping the UNaLab impact assessment framework. Local stakeholders, project partners and external experts in each UNaLab front-runner city co-identified the Key Performance Indicators (KPIs) and Key Impact Indicators (KIIs) based on the local challenges and SMART criteria in a series of group sessions. These sessions shaped the common understanding of challenges and their relative importance, as well as the expected outcomes of planned NBS actions in each city. After several iterative cycles of indicator selection, project partners co-developed a final set of common indicators for NBS monitoring and evaluation. Stakeholders further participated in the selection of appropriate monitoring protocols and the development of local co-management activities such as the engagement of students in NBS monitoring and the establishment of local Communities of Practice.

Municipal Administrations

Citizen

Planning experts

Scientists / Academia

NGOs

Main Challenges addressed

1. Climate Resilience

2. Water Management

3. Natural and Climate Hazards

4. Green Space Management

5. Biodiversity

6. Air Quality

7. Place Regeneration

8. Knowledge and Social Capacity Building

9. Participatory Planning and Governance

10. Social Justice and Social Cohesion

11. Health and Wellbeing

12. New Economic Opportunities & Green Jobs

Lessons learned

Co-development of the monitoring strategy relies on a diversity of participants, in terms of cultural and educational background and needs, which requires on-going communication to maintain active participant engagement. Steadfast stakeholder engagement proved to be essential for identifying the local challenges and monitoring and evaluation needs. Challenges in the definition of performance and impact indicators and monitoring needs were addressed through engagement of a wide range of experts during NBS assessment planning. Obstacles encountered during the NBS implementation process influenced the final set of impact assessment indicators for a few selected NBS.

Learn more
www.unalab.eu



URBAN GreenUP

New strategy for Renaturing Cities through Nature-based Solutions

Valladolid (ES) Liverpool (GB) İzmir (TR) Ludwigsburg (DE) Mantova (IT)
Medellin (CO) Chengdu (CN) Binh Dinh - Quy Nhon (VN)

URBAN GreenUP project wants to develop a new concept, "Renaturing Urban Plans (RUPs)", which include actions focused on mitigating the effects and risks of climate change and improving the air quality and water management of cities. The urban renaturing methodology developed by URBAN GreenUP is demonstrated in three front-runner cities, Liverpool (The UK), Izmir (Turkey) and Valladolid (Spain). Based on their experience, five follower cities will set up their own Renaturing Urban Plans to replicate the URBAN GreenUP strategy and act as ambassadors for a broader group of cities with a high replication potential. The main objectives of URBAN greenUP are to (1) develop and demonstrate a fully replicable renaturing methodology to support the development of Renaturing Urban Plans aimed at climate change mitigation and efficient water management; (2) involve citizens, local authorities and stakeholders in the co-design of their city renaturing plans; (3) identify innovative business plans to replicate the model in other cities all around the world; (4) foster the creation of a global NBS market and support EU international cooperation.

Drawing on knowledge from projects funded by the European Union

Image: Green cover Plaza España, Valladolid - Photo © Valladolid City Council

Approach to Impact Assessment

The key aim is to quantify the impacts of NBS in the cities to enhance the quality of life of the citizen through measuring multiple axes, following the significant principles of effectiveness, repeatable and reasonable cost. Each city partner must focus in their precise goals and aim for a monitoring program that tackles the main issues and challenges that each city is facing. Key effort during the monitoring program is to learn lessons from the process, draw data through different sources and cities and derive global conclusions that will serve the main objectives of the Project as improving citizen well-being and palliate climate change effects in cities. The monitoring program will serve as evaluation tool for not only the NBS per se but for the Project itself for many reasons. In one hand, KPIs will provide information regarding NBS but also will collect data that can be used to calculate city-wide indicators that apart from serve as NBS indicator can be used to determine further evaluation and global conclusions.

Involved Stakeholders and roles

The monitoring description and the description of the KPIs can be utilized by:

- Demo Cities and municipal administrations, enabling them to develop strategies based on the progress of the NBS.
- City residents and non -profit citizen organizations enabling them to understand the development and the baseline of the city.
- Follower cities, in order to learn from the use and application of the NBS and the improvement on the cities.
- Other professionals of urban planning, geographers, architects and landscape professionals.

Municipal Administrations (FR/FL)

Regional/national statistics authority

Citizen

Planning experts

Scientists / Academia

NGOs

Green businesses

Schools and kindergartens

Main Challenges addressed

1. Climate Resilience

2. Water Management

3. Natural and Climate Hazards

4. Green Space Management

5. Biodiversity

6. Air Quality

7. Place Regeneration

8. Knowledge and Social Capacity Building

9. Participatory Planning and Governance

10. Social Justice and Social Cohesion

11. Health and Wellbeing

12. New Economic Opportunities & Green Jobs

Lessons learned

All issues encountered during the monitoring program are shared and dealt with by all the partners involved in order to find the best possible solution.

- Storage requirements for some KPI data and who is in charge. In general, cities are in charge of the data storage.
- Coordination between who is in charge of what: obtain raw data, calculation KPI, output data owner. Partners led by the Monitoring WP accorded responsibilities, defining the roles of the different partners.
- Different timing between cities and implementations due the tendering processes. Internally managed by the front-runner cities.

As main lessons learned we can consider as following:

- The generation of participatory process between experts and partners
- The data provide useful knowledge for stakeholders beyond the purpose of the Project
- The need for storage requirements for all the data produced Role definition is required for the performance of the monitoring process.

Learn more
www.urbangreenup.eu



03

**What constitutes NBS monitoring?
How do I develop a robust NBS monitoring plan?
How can I execute monitoring and impact assessment activities?
What indicators of NBS impact can I use?
How do I select appropriate indicators of NBS impact?**

A step-by-step approach to developing robust monitoring and evaluation plans

NBS impact assessment best practices from EU H2020 projects

Why is it important to evaluate the impacts of NBS?

How can I ensure NBS work for Disaster Risk Reduction?

What kinds of NBS monitoring data can I gather, and how should I manage these data?

3 APPROACHES TO MONITORING AND EVALUATION STRATEGY DEVELOPMENT

Coordinating Lead authors

Dumitru, A., Garcia, I., Zorita, S., Tomé-Lourido, D.

Contributing authors

Cardinali, M., Feliu, E., Feroso, J., Ferilli, G., Guidolotti, G., Hölscher, K., Lodder, M., Reichborn-Kjennerud, K., Rinta-Hiiri, V., Maia, S.

Summary

What is this chapter of the Handbook about?

In this chapter, we outline a step-by-step approach to developing and implementing an impact assessment plan that covers all stages from planning and implementing to achieving policy impact. Understanding the specific steps to consider and follow when planning and implementing evaluation, will help practitioners make appropriate on-the-ground decisions that fit to their local context

We begin with introducing a structured reflection process that connects your strategic objectives, with NBS actions and expected outcomes, through the mapping of a theory of change, and the development of a logical chain of results that differentiates between process characteristics and outcomes (Section 3.1). We then delve into the steps involved in designing effective monitoring and evaluation plans (Section 3.2). Next we outline the key features and conditions



needed for a successful process of co-production of monitoring and evaluation plans, involving a diversity of stakeholders, from a quintuple helix perspective (Section 3.3). Finally, we present three innovative tools oriented to enhancing reflexivity in impact assessment and NBS design and implementation, more generally; to support the development of tailored monitoring and evaluation plans for local NBS; and to gather user data with the support of automatized procedures and technological devices (Section 3.4). The chapter concludes by stressing the role of robust monitoring and evaluation in evidence-based policy-making, the creation of a culture of continuous evaluation, and in stakeholder and citizen education (Section 3.5).

How do I use this chapter in my work with NBS?

You can use this chapter to develop your impact assessment strategy from the beginning of your NBS planning process. The chapter also outlines how monitoring and evaluation plans can feed into wider assessment, data collection, and reporting efforts, with a long-term view.

When should I use this knowledge in my work with NBS?

Monitoring and evaluation is sometimes considered too late in the process of NBS implementation that important opportunities are lost because of it. Therefore, we recommend that you use this chapter at the beginning of your planning process: it will enable you to have an overview of the steps you need to follow and thus save time and resources by initiating certain actions and collaborations early in the process. It might also be useful to review each step as you go through them, to ensure that you have considered all relevant aspects in each stage.

How does this chapter link with the other parts of the handbook?

After the in-depth description of principles that should be followed in developing robust impact assessment in chapter 2, this chapter describes the practical steps in detail, and outlines how impact assessment can be done through adopting a co-production approach. Specific indicators for each challenge category are then described in chapter 4. Considerations regarding data are discussed in chapter 5.

3.1 Introduction: developing robust impact assessment plans

Robust impact assessment is a key aspect of the urban and regional regeneration and resilience agenda in Europe. Nature-based solutions have emerged as a promising and potentially effective type of interventions for a variety of environmental, social and economic challenges. However, clear and sufficient

evidence on their different outcomes, the synergies and trade-offs between these, and the processes and pathways through which outcomes are achieved is still needed (Dumitru et al., 2020). Robust evaluation of nature-based solutions (NBS) in different cities and regions will contribute to an evidence base that can inform urban planning and interventions, investments and policy-making. In the medium and long term, it can contribute to the creation of a culture of impact assessment, as part of the design and implementation of nature-based and grey solutions.

As participants in the large-scale EC H2020 NBS projects described throughout this handbook, many cities and regions are defining local NBS monitoring and assessment plans and facing numerous challenges. Robust monitoring and evaluation plans provide important knowledge regarding the strengths and weaknesses of nature-based interventions, and the degree of achievement of the strategic objectives of the stakeholders involved. The effective development and implementation of these plans requires a thoughtful, step-by-step approach and active collaboration with local stakeholders. It is not a task that should be carried out in isolation, and this chapter seeks to offer orientation by describing in detail the step by step approach to monitoring and evaluation briefly outlined in Chapter 2, as well as outlining the key characteristics and stages involved in a co-production approach to impact assessment design and implementation.

Effective monitoring and evaluation plans have been identified as a key enabler for successful implementation of NBS (Ershad-Sarabi et al., 2019). In fact, when impact assessment plans follow, and are aligned with, local spatial development objectives, they support the transition to nature-based solutions design, by providing the evidence base for projects, plans and policies (Geneletti et al., 2016).

Collaborations between scientific experts, municipalities and other stakeholders are particularly helpful in the development and implementation of such robust impact assessment plans. Collaboration with local universities or urban professionals with scientific knowledge and experience is very valuable, as nature-based solutions have impacts across a wide range of contemporary challenges, thus requiring a wide range of scientific expertise (Raymond et al., 2017b). Successful co-creation experiences between researchers and policy officers in the design, implementation and maintenance of nature-based solutions leads to mutual learning and the establishment of relationships of trust (Frantzeskaki and Kabisch, 2016), facilitating long-term collaboration.

3.2 A step by step approach to developing robust monitoring and evaluation plans for NBS

A robust monitoring and evaluation strategy requires careful planning from the beginning of the process of NBS design. By following a step-by-step approach, adequate resources can be assigned. To make sure evaluation is both robust and cost-effective. Teams in charge of developing and implementing a nature-based solution can work through a series of six sequential steps, already briefly summarized in Chapter 2. The process is not entirely linear, and feedback loops between some of the steps exist, as described below. A synthesis of these six steps and the relationships between them is presented in Figure 3.1, illustrating

how constructing a theory of change is an iterative process, and the feedback loop between steps 2 (outlining the sequence of results) and step 3 (specifying impact), which will feed into and help refine step 1 (the theory of change).

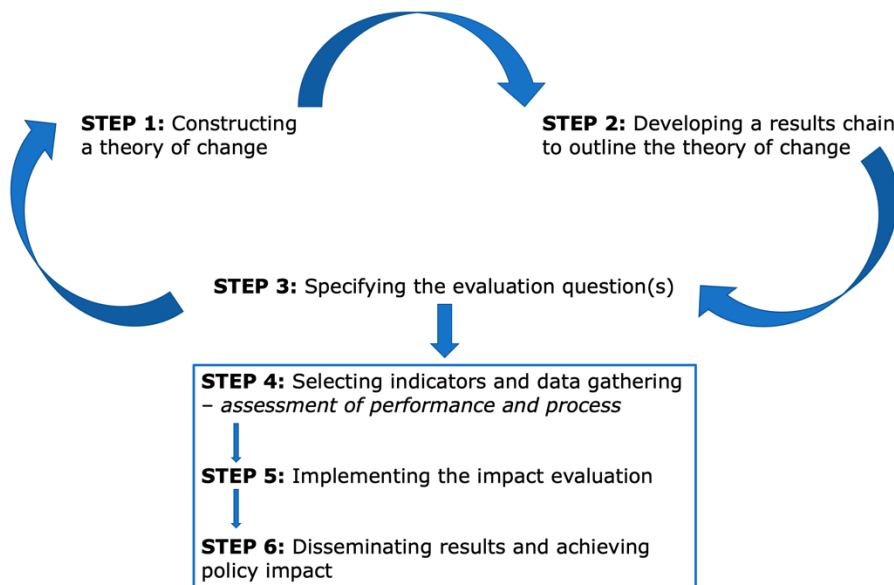

Figure 3-1. Summary of steps for developing impact monitoring and evaluation plans

STEP 1: Constructing a theory of change

The development of a theory of change enables planners and decision-makers to establish a clear relationship between key local context challenges, strategic objectives and the actions through which these will be reached, and fosters clear identification and reflection on the linkages, or pathways, between them. Developing a good theory of change takes time, but this effort will pay off in subsequent stages of monitoring and evaluation planning, by saving considerable time and money, through the anticipation and mitigation of errors. The following stages can be identified when developing a theory of change:

1.a) Engage in structured reflection on key local context challenges and NBS objectives

Structured reflection supports cities in establishing context-appropriate rationales for NBS implementation and establishing impact assessment objectives (Dumitru et al., 2021). Strategic objectives in a particular city or region are normally implemented by establishing more specific, local goals, and by identifying local challenges that call for specific policy interventions to achieve those goals. Developing a theory of change entails making these relations explicit with some degree of formalization, by providing answers to the following questions: which local goals are targeted; what city or regional strategic objectives they address; what nature-based solution/s and actions will address them; what, what specific

outcomes are expected at different stages of the change process and which specific outputs will be sought to achieve those outcomes.

Strategic goals are normally defined in strategic policy documents and defined in broad terms. Fitting or relating these to international targets such as the Sustainable Development Goals (SDGs) of the United Nations 2030 Agenda for Sustainable Development (2015) is helpful in adopting a bigger picture view of strategic objectives that will be addressed, among other, by NBS interventions and contributes to establishing connections between monitoring and evaluation efforts that are already taking place in the city or region. It also provides arguments to enhance collaborations between different stakeholders and acquire necessary funds for monitoring and evaluation.

A clear relationship should be established between specific NBS outcomes and the actions that need to be implemented at different stages, to produce those outcomes. Specific outputs should be listed for each of these actions and stakeholders should spend some time reflecting on potential interactions between outcomes that might lead to both positive synergies and unwanted trade-offs.

1.b) Involve the appropriate stakeholders and foster a sense of belonging to the process

Each stakeholder might have a different vision of the objectives to be set, the way to achieve them, or knowledge about the likelihood of different pathways connecting interventions to outcomes. Stakeholders also bring informed perspectives on local needs, as well as visions of the desired transformation and the role of NBS in achieving it. These points of view are not exclusive but complementary and will enrich the theory of change. An additional benefit of an approach that involves stakeholders from the beginning is that it fosters active engagement and a sense of belonging among stakeholders, as well as relationships of trust and cooperation (see Section 3.3 for additional detail).

Local teams responsible for monitoring and evaluation will benefit from holding regular meetings with stakeholders, in an iterative process. The vision of decision-makers will likely be enriched by other stakeholders' needs, desires, expertise and feedback on what may or may not work, and on the outputs and outcomes needed to achieve strategic goals and effectively address local challenges.

The presence of technical staff or a group of monitoring experts is important across the whole process of monitoring and evaluation, at varying intensities. Experts might be specialists in different categories of impacts or challenge areas, or in co-production activities, and they might also advise on the customization of the impact assessment plan to the capacities and resources of the city. Many times, local teams already have some technical expertise among their staff, which may be complemented with external resources, such as collaborations with scientists and universities. Experts' contribution will be essential in later stages of planning, when expertise on impact assessment methodologies and data collection is needed.

STEP 2: Developing a results chain to outline the theory of change

Following the clarification of local challenges, key local goals, and NBS actions to achieve them, stakeholders should explicitly identify assumptions regarding the mechanisms by which NBS actions will lead to expected impacts. Explicitly mapping the expected causal chain by which the implementation of the NBS will achieve strategic objectives, is useful in anticipating what may be missing in the design. Mapping causal pathways also allows for early detection of situations where NBS might not deliver all the envisioned outcomes, and beginning to ask the right questions about why that might be the case. Such a reflexive approach also fosters experimentation with tweaking design or with additional measures to improve NBS effectiveness over time.

When mapping causal pathways, the intermediary pathways through which an NBS, an NBS feature or an NBS action might lead to the expected outputs and outcomes should be clearly specified. Outcomes are the concrete results sought through the implementation of an NBS (e.g., reduce air temperature or increase mental health and wellbeing), while outputs are the visible part of NBS interventions necessary to fulfil the outcomes (e.g., create an urban green park; implement a participatory process of NBS design). The city has explicitly established its assumptions when it has achieved clarity, and can specify what actions will be carried out, what results are expected to be achieved through them, and what they think are the mechanisms that explain why an action is likely to lead to a particular outcome or result.

Imagine, for example, a neighbourhood who defines a series of strategic objectives of improving levels of physical activity in youth, and decides to create a neighbourhood park that would allow for people to be outdoors and exercise. In some cases, the assumption is that having the park in place would create recreational and exercise opportunities for youth, thus establishing a direct causal pathway between the existence of the park and physical activities. However, imagine now that the park is not accessible to a part of the neighbourhood because it does not have sufficient access points, or that particular socio-demographic groups such as cultural minorities or young women do not use the park as they do not feel safe in it. We start to see that we might need to consider additional pathways or conditions that lead to the expected outcome, such as accessibility of the park or perceived safety, and include them in the assessment.

Furthermore, two types of impacts can be distinguished. "Intended" impacts are the effects or changes that are not only desirable but are explicitly targeted through the NBS implementation. "Unintended" impacts are the (usually) negative, unforeseen results of NBS implementation. Also, each local team should establish its theory of change based on knowledge of the local context, since there are many factors that can influence the successful achievement of outputs and outcomes. Sometimes there are interrelationships of "positive effects", also called synergies (e.g., creating large tracts of urban green spaces favours biodiversity but also offers spaces for physical activity), while in other cases, there may be interrelationships of "negative effects" or trade-offs (e.g., creating parks that improve the perceived quality of urban environments, which in turn contributes to gentrification, and the exclusion of some groups).

Local teams should reflect upon and identify the possible intended and unintended impacts, as well as synergies and trade-offs that may occur across

the causal pathway. This will be of great importance in assigning causality, as described below.

STEP 3: Specifying the evaluation question(s)

The main reason for the development of robust NBS monitoring and evaluation plans is to establish the direct effect that these interventions have on addressing particular challenges and reaching certain objectives. As described in Chapter 2, impact evaluation is about answering causal questions: To what extent is this park contributing to reductions of obesity in a neighbourhood? To what extent is this urban garden contributing to reductions of depression rates in this neighbourhood, and through which mechanisms does it do so? Is it through increased physical activity, through simple exposure to nature, or through the fostering of increased contact and positive interactions between users? To what extent is this intervention more effective (if at all), than no intervention (where depression rates might improve anyway with the passing of time), or as compared to alternative, non-NBS interventions? Making these questions specific provides narrative context to the theory of change and orients the choice of appropriate indicators.

It is also useful to identify other factors that might influence the same outcomes in a given location and time period, as well as the relationship between NBS actions and outcomes. Some of these factors will be beyond decision-makers' control, but anticipating at least some of them will help with the correct attribution of causality, or, said differently, with knowing which are directly attributable to the NBS and which are not. Different options to correctly establish causal relations between NBS actions and outcomes have been outlined in Chapter 2.

STEP 4: Selecting indicators and data gathering methods - assessment of performance and process

Adequate indicators should allow for the assessment of *both performance and process*, and thus answer the following questions: does the NBS operate as designed and are outcomes consistent with the planned theory of change?

4.a) Select appropriate indicators

Throughout this handbook, indicators associated with 12 societal challenge areas (e.g., climate resilience, health and well-being, etc.) are presented. Each of these indicators has been developed using SMART (Specific, Measurable, Attributable, Realistic, and Time-bound) criteria, and each refers to the assessment of particular outcomes. Process indicators are also included, which refer to the characteristics of the NBS implementation process (e.g., number of stakeholders involved in the initial NBS design stage). When indicators are selected to assess one or several NBS projects, together they should form a coherent framework, considering the synergies and trade-offs mapped in the theory of change. In some cases, it is difficult to choose and measure all the desired outcomes and process features outlined in the previous steps, due to constraints in financial, human and

time resources. Therefore, in collaboration with the stakeholders, indicators will need to be ranked to establish priorities, to differentiate between those that are critical to the assessment of key NBS expected outcomes (recommended, or core, indicators) and those that might be desirable when additional resources and stakeholder collaborations are available and possible (additional indicators).

For each of the 12 challenge areas selected, Chapter 4 presents a set of recommended indicators, considered essential to mapping key outcomes of different types of nature-based solutions, and a set of additional indicators that might fit certain local contexts and types of nature-based solutions, but not others. Aware of the fact that resources are always limited to some extent, the list of core indicators has been kept to a minimum, while the list of additional indicators include a wide range of outcomes, and scientifically valid methods for their assessment. Local teams can start with the core indicators and progressively expand it over time, in line with policy priorities and resources.

Local teams can graphically illustrate which indicators are chosen for each of the important assumptions in their theory of change, through the use of causal maps, as illustrated by an example from the Connecting Nature project, presented in Figure 3-2.

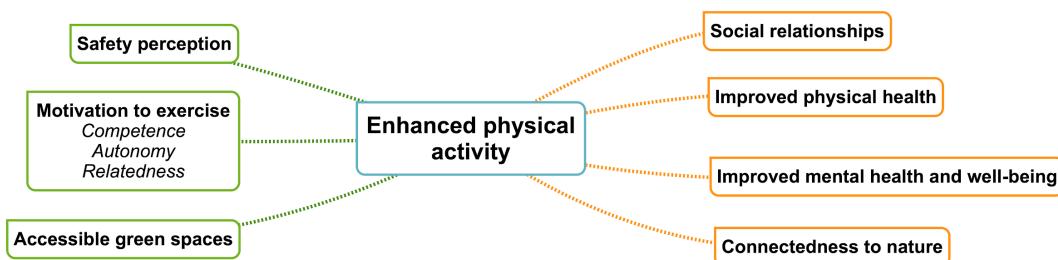

Figure 3-2. Indicator causal map
(adapted from Dumitru et al., 2021; approach used in the H2020 Connecting Nature project)

4.b) Choose an appropriate impact evaluation method

Once the indicators have been selected, within a coherent framework, the next phase will consist of identifying an appropriate method for each indicator. There may be more than one measurement method for each indicator (e.g., physical activity can be measured through a self-reported questionnaire, wearable devices or through heat maps). For each of the indicators presented in this Handbook, at least one measurement method is proposed. For those cases where end-users have to make decisions between several options, and choose a method adapted to their characteristics, the following three criteria outlined in Table 3-1 should be considered.

Table 3-1. Factors influencing selection of NBS impact evaluation measurement methods

Data quality	Involves the selection of standardized, scientifically-tested measurement instruments. High data quality is critical to enable drawing of valid conclusions, especially related to causality.
Temporal adequacy	Some NBS impacts will be registered shortly after NBS implementation, while others will take time. For example, reduction in the prevalence or incidence of different illnesses might need a long time span of 5-10 years to be registered. Frequency and temporal planning of measurements should take these aspects into account.
Cost-benefit ratio	Some methodologies provide highly detailed and accurate data but are very costly. When a particular impact is important for the city, or when over-time benefits are highly proportional to costs, these should be considered. High-quality, precise data pays off in the long term.

4.c) Identify and collect the data needed to assess selected indicators

After selecting appropriate indicators and methodologies, the next step is to identify available data and decide in which cases new data should be collected. In the previous chapter, the difference between baseline (prior to NBS implementation) and outcome data (data subsequent to NBS implementation) was explained (see also Figure 3.3). The absence of baseline data considerably limits the possibility of attributing impacts to the implementation of the NBS. Certain relationships may be observed, but it will be impossible to know for sure whether they are due to the NBS, or whether they might be due to other co-occurring phenomena.

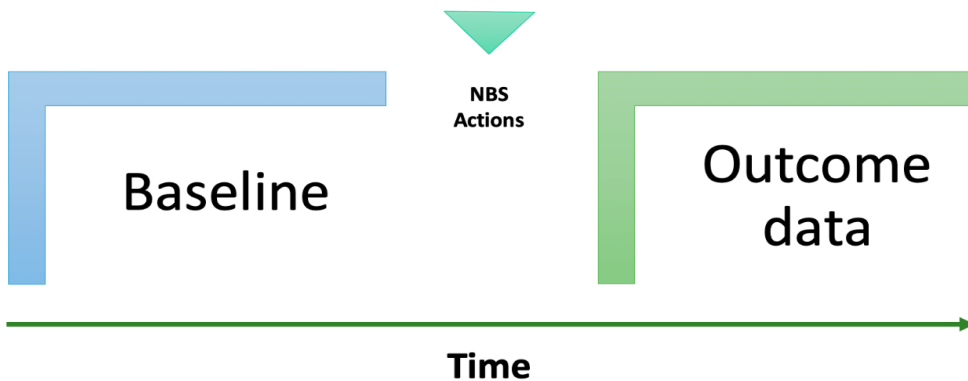

Figure 3-3. Baseline vs Outcome data (adapted from Dumitru et al., 2021)

It is strongly recommended to either detect data sources for the baseline and then collect outcome data, or, where data is not available, plan for baseline data collection before NBS design and implementation takes place. Moreover, given adequate resources, as well as the possibilities afforded by certain automatized

forms of data collection (such as wearable or remote sensors, smartphones, etc.) data might be also collected at several times before, during and after NBS implementation, thus allowing for higher precision and the detection of subtle variations as a result of NBS implementation.

In some cases, data is already available through public, private or third sector agencies at national or international levels. Thoroughly reviewing available data, as well as attempting to connect data collection with existing and regular survey, monitoring and reporting efforts at regional, national or international levels will mean that monitoring and evaluation of NBS can become a regular practice and be maintained and enriched over time.

4.d) Developing a local monitoring and data collection plan

The development of an effective local monitoring plan should consider a structured sequence of actions (CLES, 2010; Compass, 2010; United Nations, 2009), that together form a coherent data collection plan, with specific requirements regarding types of data, target populations and samples to be used, specific data analysis techniques and provisions for the protection and storage of data. Questions that the monitoring and data collection plan should answer are shown in Table 3-2. First, stakeholders should be assigned different roles in the monitoring and data collection process. These can be divided into four general categories: those in charge of making key strategic decisions; those in charge of particular research activities involved in monitoring; those carrying out the monitoring activities (the “fieldwork”), and those who provide general assistance or support across all stages. Secondly, tools for monitoring should be set in place, linked to the specific methods chosen for each indicator. These might include specific equipment, questionnaires, or enabling technologies. A monitoring schedule should be established, detailing when particular measurements will be taken. Finally, a clear data collection plan should be established, by providing answers to the following questions:

Table 3-2. Questions to answer through the local monitoring and data collection plan

<i>For the monitoring activities</i>	<i>For the data collection and storage plan</i>
What will be monitored? (includes expected outcomes and chosen indicators)	Which type of data will be collected and what is the target population or type of sample?
Where will monitoring take place? (location of monitoring tools and data collection)	Who will analyse the data? (which stakeholders or partners will perform the analyses)
Who will do the monitoring? (Stakeholders responsible for each type of data collection)	Who will store the data? (stakeholders responsible for the data platform and/or data base)
When will monitoring take place? (Schedule – times and frequency of data collection)	How will data be presented? (how the results of monitoring will be presented to inform policies, citizens and decision-making processes)

Throughout this process, risks may arise in data collection activities, such as delays in data collection, low response or unaffordable costs for municipalities. Establishing risk mitigation plans before the start of data collection will make it easier for local teams to avoid delays and inefficiencies.

STEP 5: Implementing the impact monitoring and evaluation plan

Implementing the impact evaluation, evaluating positive/negative features of NBS impacts related to the different challenges, analysing and interpreting the findings. Once data has been identified and collected, the next step is to analyse and interpret it, in order to assess NBS performance in achieving established objectives, and assess both positive and negative impacts, as well as synergies and trade-offs. This might entail looking at results of several impact evaluation rounds in combination as these may be relevant on the achievement of a particular objective. If several outcomes impacts (positive and/or negative) are considered in relation to an expected objective, the performance evaluation should consider trade-offs and possible differences in time scales over which indicators show that an objective has been achieved or not. Multi-criteria analysis may be used to consider the different views of stakeholders.

The results of the data analysis should be related to the initial objectives outlined in the theory of change. Local teams will thus be able to check whether NBS actions have had the expected impact, or, on the contrary, have had undesired effects. This is a good time to reflect on whether there are synergies between outcomes, or whether there are trade-offs. As Chapter 2 underlines, in case the results are not as expected, it is necessary to be careful when concluding that the NBS actions are not effective. Actions may have the expected effect, but over a longer time span.

Temporality is thus an element to consider in the global analysis of outcomes. Some impacts (e.g., promoting social cohesion in a neighbourhood) require a longer time to become apparent, while others can be verified almost immediately (e.g., reducing local temperature through green walls). It is strongly recommended to make evaluation an ongoing process, with different data collections over time, to better assess changes.

Furthermore, conclusions should not be drawn solely based on the change in an indicator before and after implementing the NBS, but to do a benchmarking process where scientific standards are taken into account that indicate which values are appropriate for an indicator (e.g., not only assess a decrease in pollution levels after implementing an NBS, but consider when the decrease is in line with scientific criteria). Figure 3-4 illustrates the monitoring strategy workflow used in the EU H2020 CLEVER Cities project, to illustrate the different stages involved in the implementation of a monitoring and data collection plan.

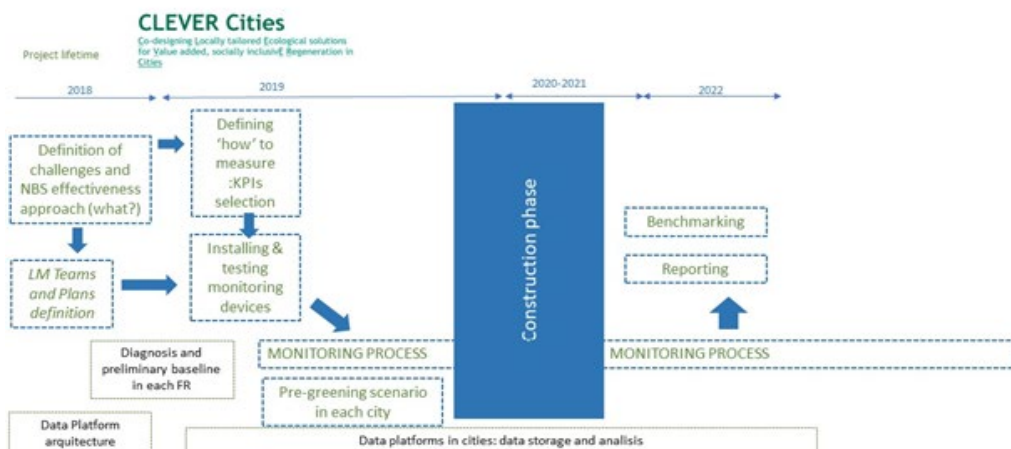

Figure 3-4. Impact Assessment process in the CLEVER cities project lifetime (Tecnalia, 2018)

STEP 6: Disseminating results and achieving policy impact

The last stage of the NBS impact assessment process involves the dissemination of results as well as making provisions to embed them into policy practice. The wider the dissemination, the more benefits it will have: citizens will be informed of the activities of their local government, companies will be made aware of business opportunities, and scientists will be able to continue advising on and researching the best methodologies for NBS impact assessment.

We stress the importance of not only registering and reporting positive results, tempting as that may be, but to do so for all the results obtained. Although it is often tempting to only consider and disseminate positive effects, knowing what has gone wrong or which parts of the implementation are susceptible to improvement in the future are of utmost importance in order to not repeat mistakes or waste resources by implementing the same ineffective strategies and solutions elsewhere. It is also very important to disseminate both outcome and process results. Reporting all results will mean that knowledge and evidence will accumulate, benefitting everyone working with NBS.

Disseminating the knowledge generated by the local team to others not only helps in the replicability of NBS, but also positions city councils as role model. Different collaborative actions can be carried out to help disseminate the data, such as scientific articles, official reports, conference presentations, talks and webinars, or social- and mass-media interviews. It is also very helpful to create integrated and highly visual representations of impacts, and where possible include a spatial or GIS component to the visualization of the data, to support decision-making. The more attractive and easier to navigate these data dissemination platforms are, the more they will enable stakeholder collaboration and evidence-based decision-making in the future.

The creation of NBS impact dashboards by cities or regions, which integrate GIS technology, and allow interaction with different types of data, are gaining

prominence. The following image is an example of the impact dashboard created in the city of Glasgow as part of the Connecting Nature project, as a way to map and represent outcomes of the City's Open Space Strategy and the impacts of NBS implementation in different areas. The dashboard allows viewers to visualize the interplay of different indicators (e.g. health status, social deprivation, green space distribution) in a particular city location, and provides a flexible structure that will be further developed as additional NBS are implemented and additional data becomes available. It is also a useful instrument to identify types of indicators and data that might be missing, thus orienting future impact assessment decisions.

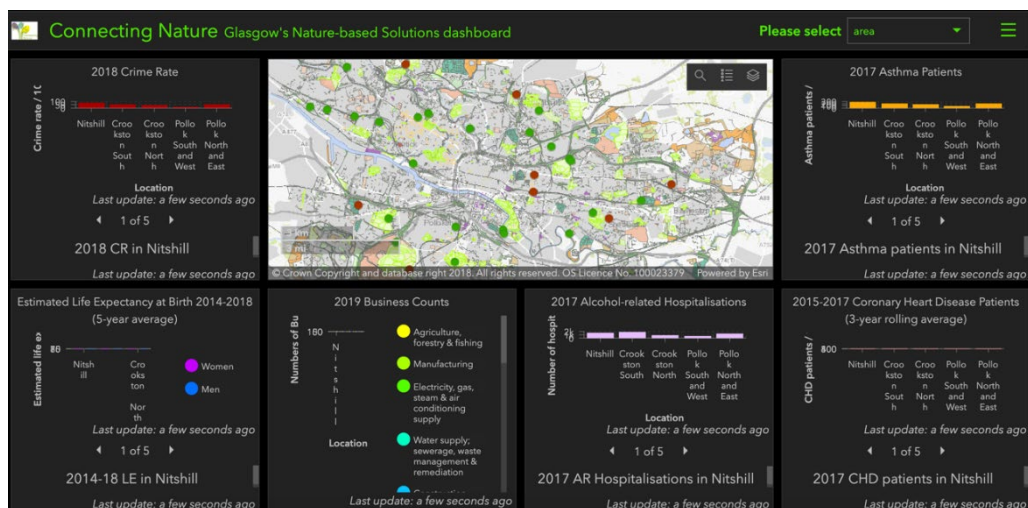

Figure 3-5. Glasgow City Council Dashboard (© Glasgow City Council), the Connecting Nature Project

3.3 Robust impact assessment and co-production: a necessary relationship

The design, implementation and evaluation of nature-based solutions require the collaboration of different stakeholders. Although the design and implementation of monitoring and evaluation plans is often considered the part of the process where most technical and scientific expertise is required, we argue that monitoring and evaluation can also benefit from collaborative, co-productive approaches. The knowledge, expertise and lived experience of many stakeholders is relevant when deciding what outcomes to evaluate, when identifying existing local needs, as well as when implementing monitoring strategies and gathering relevant data. Using well-designed collaborative approaches can also reduce costs and enhance NBS ownership, as, for example, when using citizen science approaches to monitor biodiversity. Even for the most technical parts of monitoring and evaluation, such as deciding on where and when to use certain equipment for data collection, using a collaborative approach can ensure that residents are knowledgeable of the reasons for it, and they can contribute to equipment maintenance and/or safety. Citizen participation in monitoring and

evaluation efforts can enhance socially innovative solutions and accelerate the transition to sustainability (Faivre et al., 2017).

Moreover, the multifunctional nature of nature-based solutions will mean that different administrative departments and agencies will need to be involved in monitoring and evaluation (Calliari et al., 2019). Monitoring NBS impacts in different urban, rural or coastal conditions advances the knowledge acquired by local authorities (Frantzeskaki et al., 2019). Co-production will provide opportunities to change traditional ways of thinking and planning (Bush and Doyon, 2019). Impact assessment might require the use of data collected and kept in the custody of different departments, thus overcoming data and monitoring silos. Changing traditional silo-type modes of operation, where ecological, social and economic objectives are considered separately, the focus needs to shift to a broader conceptualization of urban resilience and regeneration (Dumitru et al., 2020), and to an institutional culture of cooperation (Frantzeskaki et al., 2019). Finally, business sector stakeholders can provide valuable information related to the economic and environmental dimensions of the NBS. Different stakeholders help to highlight weaknesses, to prioritize interventions and to identify the adequacy of assessment tools for diverse locations (Beceiro et al., 2020).

The degree of stakeholder participation will depend on whether their points of view are taken into consideration by local governments and on their proximity to the decision-making process of interventions (Wamsler, 2017). Planners can think of this in terms of a continuum, ranging from centralized, hierarchical decision-making to decentralized, participatory monitoring and evaluation where stakeholders take joint ownership of the process and are actively engaged at each stage. Different models, or positions on this continuum, have their pros and cons. Centralized or hierarchical decision-making models ensure a fast and potentially less expensive process, but can be seen as poor processes by the citizens and generate reactivity, thus undermining acceptability of different NBS strategies and projects. On the other side of the continuum, participatory models require a greater investment of resources (time and budget), but contribute to citizen ownership of the solution, the creation of a culture of collaboration and engagement, as well as a sense of community and belonging, and in the long term might lower costs through good maintenance of the solution by the community. Co-production approaches will also foster greater NBS-related business opportunities through engagement with the business sector, as well as increased network creation and trust-building.

Co-production is different from consultation or information provision, and the key differentiating feature is that stakeholders are involved from the very beginning in the development of monitoring and evaluation plans, in each of the steps described in section 3.2.

We highlight five stages that are important for the co-production of impact assessment plans. Importantly, outlining a co-production strategy and creating specific co-production plans should happen at the very beginning of the process of NBS design and implementation. Co-production stages are also iterative. It is important to continuously reflect, redefine and adapt the process of monitoring and evaluation co-production if and when needed.

It is also important to keep in mind that co-production is not a panacea. Ensuring good quality co-production requires the development and strengthening of new types of skills, resources and relationships to foster exchange and collaboration between stakeholders. It is thus of paramount importance to take time at the outset of the process to establish good relationships with stakeholders from the outset, for which good communication skills and openness to multiple perspectives is helpful. We highlight here the key stages in the planning and implementation of an effective co-production process.

Stage1: Define the goals of, and create space for, the co-production process

The goal of co-production of monitoring and evaluation of nature-based solutions should be clarified from the start, by addressing questions such as: To what ends do stakeholders need to be involved? Which amount of time needs to be allocated to the co-production process? The goals need to be clearly communicated to potential funders as well as participants. People are more likely to become actively engaged when outcomes are clearly visible, and their opinions are authentically considered and appreciated.

Answers to these questions will determine the goals that influence which actors should be involved and in which steps of the process. Depending on the objectives and time availability, the goals of co-production can pertain to each of the steps outlined above, or a choice can be made to involve (different types of) stakeholders in specific steps. For example, in the development of a theory of change (Step 1), cities can benefit from the knowledge of the various stakeholders to understand local needs, desires for change and how the NBS can address them. Shared aspirations for outcomes can be formulated collaboratively from the beginning. Other stakeholders can be involved later on in the collection and interpretation of data (Step 5), as well as in debates and decisions on how to adapt the NBS to improve outcomes.

Co-production requires a high amount of time and resources, openness and trust, as well as (political) support and motivated participants. This needs to be considered in the initial goal setting and time planning to allow and plan for sufficient availability of time for things like initial preparation of the co-production process, mobilisation of stakeholders or processing information for each subsequent monitoring and evaluation step.

Stage 2: Identify and reach out to the actors that will be involved

Secondly, the actors that are sought to be involved need to be identified and contacted. Who should be involved depends on the nature-based solution itself, including where it is located and who is affected. It is important to explicitly go beyond the usual suspects to guarantee greater inclusion and participation of the weakest and give voice to critical perspectives.

Actor mapping tools facilitate the identification of suitable participants. The Quintuple Helix approach helps identify key stakeholders across different audiences to be targeted as part of the co-production process: 1) Academic; 2) Industry, firms, economic system; 3) State, government, local political system;

4) Media-based and culture-based public – local communities, community groups, NGO’s – mainstream and local media, environmental media; 5) Natural environments of society – NGO’s, policy makers, political bodies, experts and opinion leaders on NBS.

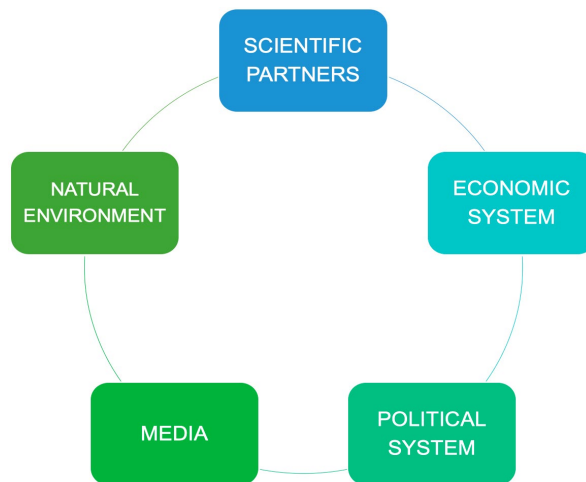

Figure 3-6. Quintuple Helix Stakeholders (adapted from Carayannis, Barth, and Campbell, 2012; Dumitru et al., 2020)

It is important that stakeholders in each of these categories are identified early on, and decisions are made about how they might be engaged, depending on the objectives identified. We should not only consider the type of knowledge these stakeholders can provide at different monitoring and evaluation stages, but also what type of knowledge and expertise might they also acquire through this process, how the process can contribute to building confidence among some of the more vulnerable stakeholders, and empower them for further meaningful participation in the implementation of the NBS.

Mobilising diverse actors requires boosting and tapping into motivation for participation. While people might be intrinsically motivated, co-production requires time, effort and money, and (shared) benefits might only be felt in the long-term. Levers for motivation can include money-related complements (e.g., financial support, training), but also social, cultural and psychological factors including social rewards, feeling part of a group and socialisation of the behaviour of participation and collaboration.

Actively going out to communities and holding regular meetings that are open to all are important conditions for enabling co-production. In addition, adequate follow-up is essential: when participants feel that they have wasted their time, they might become frustrated and disempowered to take up initiative in the next stages. Each meeting and discussion stage should be followed by feedback and the integration of issues raised into the subsequent discussions in a meaningful way (or at least providing reasons for why particular ideas might not be possible, or were not integrated). It is also important to monitor who does (and does not!) benefit from the results.

Additionally, the different roles and responsibilities for organising the co-production process need to be defined. Think of roles and responsibilities in terms of process design, facilitation, aggregating the generated knowledge, communicating results etc. The co-definition of roles and responsibilities in the process gives clarity about what is expected from actors and helps them feel comfortable in and adopting their (new) roles and functions.

One of the challenges of co-production is balancing all the interests and needs. For example, each stakeholder might have a different vision about the objectives to be set in the city's theory of change. Inclusive co-production means that the process format is based on mutuality, reciprocity and equality between different groups (e.g., experts, citizens), for example in terms of considering capabilities and time restrictions of different groups and giving equal voice to everyone. Communication and engagement need to consider the different capabilities, values, languages and resources of participants, as well as potential pre-existing cooperation or contestation between actors and institutional power structures. Ideally, this allows for open discussion and sharing of opinions in a joint learning setting, which builds on the recognition that different views are not exclusive but complementary.

Stage 3: Plan the co-production activities and tools

Thirdly, the co-production activities have to be planned with a timeline of when these are going to happen. The main question to be addressed here is 'how', relating to the right type of formats and tools to engage with the stakeholders. For example: How should different actors be involved in the construction of a theory of change? How will they be involved in the selection of indicators and data collection?

Specific co-production tools facilitate each step of the process towards desired goals. Tools are highly diverse. The choice of tools depends on the goals of the co-production process, on the specific impact monitoring and evaluation step, and on the type of actors involved. For example, visioning exercises serve to generate inspiring future images and ideas; they are particularly useful at the beginning to support the development of a theory of change, as well as to align diverse actors and to create long-term, systemic and normative aspirations. Citizen science approaches can support wide data generation, but need to be complemented with workshops for joint reflection upon the data.

Citizen science refers to public participation in scientific research and projects, not only to collaborate with scientists collecting data but also has the potential to engage the public in research by modifying the knowledge, attitudes and behaviour of citizens (Peter et al., 2019). This participatory research can promote the efficiency and effectiveness of research processes, as well as foster social inclusion, empowerment and sustainability (van de Gevel et al., 2020). Citizen participation through citizen science can provide a wealth of data to create evidence that can address real-world problems, which would otherwise be insurmountable for small teams of professionals (Gildefer et al., 2019)

Performing a classification of citizen science projects, linked to voluntary forms of participation, Follet and Strezov (2015), grouped these projects into: a) contributory projects: citizens participate in data collection and analysis, as well

as in the dissemination of results; b) collaborative projects: in addition to the previous functions, the participants would help in the design of the study and interpretation of the data and conclusions; c) co-created projects: collaboration would be carried out at all stages of the project, from the development of hypotheses to the discussion of results, and the answer to new research questions. Therefore, in the monitoring of the NBS, citizens can be involved from the co-design of the strategic objectives of the local authorities, until the last phases of data collection and transfer of results.

Although citizen science approaches have a lot of potential, they are not appropriate for all types of outcomes assessed, especially those for which specific expertise is required (Wamsler et al., 2020). Although the data collected by citizens may sometimes have levels of accuracy similar to the data collected by experts, participants need to be engaged for long time periods in larger groups and with specific training (Aceves-Bueno et al., 2017).

The co-production activities and tools need to be planned from the outset, following along the steps for impact assessment and monitoring, but also considering that the process will likely need to change and adapt.

After selecting the co-production tools, it is important to identify the materials, skills and other requirements needed to implement the tool. Think for example of the space/room, atmosphere and time needed.

Stage 4: Reflect on the co-production process and results

Co-production processes are never set in stone. They are open processes and evolve over time as learning progresses. They 'go with the flow' of the participants' ideas and needs. This requires continuous reflexivity. Reflexivity helps to identify lessons learned and to adapt the process in light of (changing) objectives. Which goals does the process aim to achieve? Is the process on the way to achieve these, or do we need adaptations? Reflexive monitoring can help to achieve reflexivity (see section 3.4.1).

Stage 5: Communicate about the co-production process

The co-production process and results need to be politically and societally known and accepted. This closely links to Step 6 (dissemination of results and achieving policy impact) of the impact monitoring and evaluation plans. This can be achieved through outreach and awareness raising activities such as campaigns and public events. Communication formats should be accessible, tailored to and inclusive of different target audiences, use innovative techniques (e.g., storytelling, puppet play, etc.), tell an inspiring story and clearly articulate the results. The participants of the process can be actively engaged in such activities.

If the evaluation and monitoring process is broadly known, greater collaboration can be achieved and thus obtain data from more sources, therefore, co-operation with the media can help disseminate the importance of evaluation. Finally, science-practices partners (i.e., universities, research institutes, etc.) serve as guides in cities to carry out each of the steps of the process. Academic entities can establish synergistic collaborations with cities, being able to use the evaluation results to disseminate them internationally, and to accumulate more

evidence on the NBS. Successful approaches can then be transferred between case studies, communities and countries (Raymond et al., 2017a), with the support of the established networks.

3.4 Innovative tools for monitoring and evaluation of nature-based solutions

Monitoring and evaluation of nature-based solutions can benefit significantly from technology-supported innovations. Collaborative technological approaches have been encouraged (Ershad-Sarabi et al., 2019), and the existence of new platforms that facilitate co-production and interaction between citizens and governments, especially in the context of urban development, has been highlighted (Falco and Kleinhans, 2018). We provide a few examples of innovative methodologies for monitoring and evaluation: a collaborative approach to enhance structured reflection and reflexivity regarding monitoring and evaluation; an online tool to create robust monitoring and evaluation plans; and a smartphone-supported, automatized data collection and citizen engagement tool.

3.4.1 Reflexive monitoring - Connecting Nature project

Reflexive monitoring is a participatory and dynamic monitoring and learning process that enables practitioners to gain insight into the progress and direction of their nature-based solution project in real time, and not only retrospectively. Reflexive monitoring stimulates learning, supports the identification of barriers and opportunities and enables flexible responses to changing circumstances and objectives. It is about adopting a reflexive mind set: reflexivity is the ability to interact with and alter the environment within which one operates. This allows practitioners to take actions that influence the context in which they work for the implementation of their nature-based solution. It is a particularly useful process for the nature-based solution core project team, although it can be adapted to involve and stimulate reflexivity among a wider range of stakeholders.

Reflexive monitoring can help for example with continuous reflection about whether indicators fit the outcomes and goals of the project or whether they need adaptation, or the appropriateness of data and data collection. It can also support reflection about the process itself, including whether there needs to be more time for co-production, or whether the right stakeholders are involved.

Within the H2020 Connecting Nature project, the innovative reflexive monitoring tool has supported cities in reflecting on their progress in the planning, delivery, evaluation, and stewardship of NBS, being able to record what actions allowed them to overcome the difficulties encountered. The following section is based on the Reflexive Monitoring Guidebook by Lodder et al (2020). The Connecting Nature cities of Genk (Belgium), Glasgow (Scotland) and Poznan (Poland) have found it is wise to reserve space and time to become familiar with the steps and the tools before proceeding with them. Once the reflexive monitoring process is aligned with your daily activities, you will be able to identify the benefits and act on what you learn.

For the Connecting Nature cities, a six-step procedure (see Figure 3.7) has been developed to implement the reflexive monitoring process. These steps can be applied in parallel to the steps for developing impact monitoring and evaluation plans. Reflexive monitoring should accompany all the steps outlined for robust impact assessment.



Figure 3-7. Steps in the reflexive monitoring process with accompanying tools (source: Lodder et al., 2020)

The reflexive monitoring process outlined below is supported by seven reflexive monitoring tools which may be applied by NBS practitioners. The tools are based on a selection of the tools presented in the Reflexive Monitoring in Action guidebook by Van Mierlo et al (2010).

RM step 1: Rethink what learning process you need to achieve the goals of the Nature-based Solution

When describing the process of co-production, we stressed the importance of clearly defined co-production goals. Beyond the goals of the nature-based solution, and the process of co-production, we also recommend identifying clear learning goals for the different actors involved. It includes how the process of NBS design and implementation is different from other planning processes, and the different departments that need to be involved. Next, it is important to acknowledge that reflexive monitoring is a novel process for all actors involved. For it to be successful you need to plan for space and time to get acquainted with the tools and to include them into your daily activities.

RM step 2: Define the roles within the project team

From the very outset of the reflexive monitoring process, it should be made clear that each actor has a role in the process and that exercising this role will involve collaborating closely and meeting regularly. The level of involvement of each one depends on the steps in the process.

RM step 3: Start with recording important events and translate them into your dynamic learning agenda

Start with recording a timeline of events during one or two months. This is to trace important moments, insights, events, that influence the development of the impact monitoring and evaluation plan. Discuss the timeline of events with your project team and distil important moments in time where something changed that helped or hindered to process. Include the critical turning points to your dynamic learning agenda and add learning questions and follow-up questions for each turning point. This allows for collective reflection on the essence and difficulty of the challenges that are dynamic and change over time. The objective of the dynamic learning agenda is to link long-term aims and learning objectives to concrete actions in the short term. By formulating, recording and tracking challenges in time the learning journey itself can be evaluated as a dynamic process.

RM step 4: Use learning sessions to identify learning outcomes

This step is about supporting the team to improve the learning process and analyse the outcomes. To facilitate this, we recommend the organising of learning sessions with the reflexive monitoring team. During the learning sessions each newly added item on the dynamic learning agenda is discussed. The critical turning points in the development of the project and learning questions are discussed and if needed reformulated to increase their reflexivity. After all items on the dynamic learning agenda are discussed, the expert and team identify learning outcomes. Learning outcomes are innovative ways the team handles the barriers or opportunities captured in the dynamic learning agenda.

We operationalized a framework for reflexive learning outcomes based on Beers and Van Mierlo (2017) that distinguish between the following categories: (1) Rules guiding actors' practices, for example tendering procedures or the way a city department is organised; (2) Relations between actors and between the nature-based solution and its context, for example who is involved in the planning process; (3) Practices concerning common ways of working, for example how the team collaborates internally; and (4) Discourse related to the future of the nature-based solutions, for example the way a mayor talks about the benefits of nature-based solutions for the city. Analysing learning outcomes in detail helps the team to better understand and explain to others what they learnt, identify remaining gaps in knowledge that can be covered through additional stakeholder collaboration or training and capacity building exercises, and highlight innovations in urban planning, including the monitoring and evaluation dimension of NBS.

RM step 5: Communicate about the reflexive monitoring process to peers and project outsiders

Reflexive monitoring is a novel governance process that allows many lessons to be learned. It is valuable to share these lessons, along with tips and tricks, with other actors who might benefit from the method. The following two tools are selected to support this exchange: the eye-opener workshop and the personal learning narrative. The purpose of eye-opener workshops is to share what is learned from co-producing nature-based solutions with people who are not yet involved in your project. For example, colleagues from other departments, the mayor's office or professionals working with co-production or involved in nature-based solutions projects. Personal learning narratives are stories that describe the learning journey of yourself or your team members throughout the co-production process. These may take the form of an experience, a hindering factor, a struggle or a challenge. These personal stories can be shared in different ways to supplement regular reports. For example, a participant records a video about his or her own learning journey and it is shared through social media or played at an eye-opener workshop.

RM step 6: Reflect upon reflexive monitoring as a method for knowledge generation regarding how to educate about the multiple benefits of nature-based solutions and how to adapt the planning process in real-time

In step six, sessions can be organised to reflect upon the effectiveness of the reflexive monitoring method itself and compare and share the learning outcomes. These sessions give practitioners the chance to share their experience of working through the various steps and using the tools of the method, which may in turn be adapted based on the feedback received or changing needs. Peer-to-peer learning events can be used for the sharing and comparing of the learning outcomes of different teams. Think of organising sessions to learn how others dealt with similar challenges and barriers, sharing personal learning narratives and celebrating innovations to inspire each other.

3.4.2 iAPT (Impact Assessment Planning Tool) - Connecting Nature project

Developed within the Connecting Nature Project, iAPT is intended to be a decision-support tool for cities to create their NBS evaluation and monitoring plans. The main objective is that users, mostly urban planners, can obtain their individualized monitoring and evaluation plan adapted to the characteristics of their location, online, easily and intuitively.

The tool supports planners and project teams to go through an abbreviated version of the step by step process described at the beginning of this chapter. After users indicate some characteristics of the location, placing it on an interactive map, they outline their theory of change, by reflecting on the characteristics of their NBS and explicitly relating them to certain outcomes, by choose from a list of possible impacts grouped into different impact categories (e.g., health and wellbeing, social cohesion, greenspace management, etc.).

Once users have made their initial selection of benefits, iAPT provides suggestions regarding relevant indicators to assess identified expected outcomes. Users will be able to consult a series of factsheets regarding methodologies for particular indicators to get a better idea of what they represent and what methods and measurements can be used for them. While users will select which indicators to measure, iAPT will suggest other indicators that are equally important and might not have been considered by the project team, to create a coherent impact assessment framework that reflects the multifunctional character of nature-based solutions.

Subsequently, iAPT will offer various methodological options for each of the indicators. As explained in this chapter, users must make the choice considering three criteria: data quality, temporal adequacy, and the cost-benefit ratio. The tool will be connected to the recently launched Connecting Nature-Based Enterprise platform, to suggest nature-based enterprises or experts that provide support or services for a given monitoring and evaluation step or component.

Finally, users will be able to obtain and download a specific assessment plan for their NBS, adapted to their location. This plan will contain the selected indicators, how to measure them, as well as supplementary material and methodological recommendations. Users can carry out the customization process as many times as they deem convenient. Future developments of this tool could link the evaluation plans with real data of the indicators, to complete the whole process of data analysis and help in the dissemination of results.

3.4.3 Urban GreenUP Tool - Urban GreenUP project

As part of the monitoring strategy of the city of Valladolid, a smartphone application has been developed by GMV, within the Urban GreenUP Project. This is an example of an innovative technology-supported data collection platform, conceived to act as another sensor for the monitoring program of the city, and track both the interest generated by the NBS in citizens, as well as to assess the use of the Green Corridor. The application will allow the collection of various interrelated data relating to a specific user (with an identified profile). Some of these data are collected automatically, by leveraging Smartphone sensor (positioning by GPS/BT; position and time spent in an NBS), and others will be actively filled in by the user (surveys, ratings). All the information provided by the users is treated anonymously.

The smartphone application is also designed to raise awareness and increase nature-based solutions engagement, showing a notification if it detects that the user is near a relevant location, and providing information regarding the purpose of the deployed or planned NBS. It can contribute to data collection for the following challenges: Green space management (Sustainability of green areas; Quality of life for elderly people; Perceptions of connectivity and mobility; Recreational cultural value); Participatory planning and governance (Perceptions of citizens on urban nature); Social justice and social cohesion (Green intelligence awareness); Public health and well-being (Increase in walking and cycling in and around areas of interventions).



Figure 3-8. URBAN GreenUP tool (Source: GMV-S).

Acknowledgements: Fátima López Mateos, Jesús Ortuño Castillo [GMV, URBAN GreenUP partners], Alicia Villazán Cabrero [Valladolid City Council, URBAN GreenUP partners and front-runner city]

Moreover, the smartphone application promotes the use of the green corridor throughout scoreboards and gamification. A scoreboard can serve to motivate the users through the use of rankings, or by providing information on usage scores in general. It also serves as a vehicle for promotions and discounts related to the NBS. The information will be sent to a server platform that will store the actions and information provided by the users (location and information). Data collected will be used to calculate some of the indicators for the Valladolid monitoring program. Currently, the use of the App and data beyond the European project is not foreseen, but could be an option to consider in the future. For the municipality, this data collection is important not only in terms of assessing the impact of the URBAN GreenUP project as a whole but also as an indicator of the degree of citizen acceptance of the re-naturalization actions implemented by the City Council.

The application will allow the collection of various interrelated data relating to a specific user (with an identified profile). Some of these data are collected automatically (position and time spent in an NBS), and others will be actively filled in by the user (surveys, ratings). The information provided by citizens when completing their profile is used to segment the results providing data for monitoring and evaluation by social groups. This segmented analysis of how each social profile uses and perceives NBS can be applied in the design of future urban re-naturalization plans

This monitoring system is a considerable improvement over more traditional monitoring methods. As a main advantage, the use of these technologies encourages the interaction of citizens and their participation in the design of their own town. As a drawback, it should be noted that the population sample studied is only that which handles these technologies and maybe a non-representative population sample.

Although the app is not open source and has been specifically designed for Valladolid city and their specific NBS actions, functionalities can be adapted to other cities.

3.5 Conclusions

Throughout this chapter, the importance of developing robust evaluation and monitoring plans has been emphasized, to assess the processes, outputs and outcomes involved in NBS design and implementation. Also highlighted in this chapter is the idea that NBS impact assessment should not be conducted in isolation by local authorities, but must have the support and active collaboration of multiple stakeholders such as scientists, companies, media, citizens and policy makers. The closer local teams are to the co-production end of the continuum, the richer, more effective and less costly impact assessment will be, while acceptability, empowerment of vulnerable groups and the creation of a culture of NBS evaluation will also be fostered.

Monitoring and evaluation in cities and regions can also have a clear educational role, since it is possible to learn from mistakes and disseminate successes (Pappalardo and La Rosa, 2020). Evaluation contributes to the development of long-term plans and goals for NBS (Kabisch et al., 2016), and leads to new insights and active learning, including failures, to improve future implementations (Connop et al., 2016). Impact assessment should be carried out across multiple categories of impacts, and synergies between outcomes should be considered, as well as NBS evolution over time (Calliari et al., 2019).

Throughout this handbook, you will find descriptions of many different European NBS projects and their monitoring and evaluation frameworks and strategies. They illustrate the step-by-step approach outlined at the beginning of this chapter, and are examples of different co-production strategies for monitoring and evaluation. Many of the difficulties encountered revolved around the lack of an evaluation culture on at local levels, which resulted in monitoring and evaluation not being planned from the beginning, as well as to many misconceptions about indicators, methodologies, costs and efforts. Collaboration between scientists, technical experts, municipalities and other stakeholders contributed to overcoming these barriers and advancing knowledge on conditions for successful and robust impact evaluation for nature-based solutions. Lessons from all these projects have been captured in the principles and approaches described here.

The ultimate goal of the process of creating robust impact assessment plans on a local level is to gather long-term robust evidence regarding NBS performance in particular spatial contexts and for different social groups, and to embed this evidence to support smart policy decisions to foster sustainability, wellbeing, and resilience (Dumitru et al., 2021). By establishing a culture of periodic evaluation, local authorities will be able to learn with each intervention and get as close as possible to achieving their strategic goals and building sustainable and socially just environments.

3.5 References

- Aceves-Bueno, E., Adeleye, A.S., Feraud, M., Huang, Y., Tao, M., Yang, Y., and Anderson, S. E., 'The accuracy of citizen science data: a quantitative review', *Bulletin of the Ecological Society of America*, Vol. 98, No 4, 2017, pp. 278-290.
- Beceiro, P., Brito, R.S., and Galvão, A., 'The Contribution of NBS to Urban Resilience in Stormwater Management and Control: A Framework with Stakeholder Validation', *Sustainability*, Vol. 12, No 6, 2020, Art. no 2537.
- Beers, P.J. and van Mierlo, B., 'Reflexivity and learning in system innovation processes', *Sociologia Ruralis*, Vol.57, No 3, 2017, pp. 415-436.
- Brandsen, T. and Honingh, M., 'Distinguishing different types of coproduction: A conceptual analysis based on the classical definitions', *Public Administration Review*, Vol. 76, No 3, 2016, pp. 427-435.
- Bush, J. and Doyon, A., 'Building urban resilience with nature-based solutions: How can urban planning contribute?', *Cities*, Vol. 95, 2019, Art. no 102483.
- Calliari, E., Staccione, A., and Mysiak, J., 'An assessment framework for climate-proof nature-based solutions', *Science of the Total Environment*, Vol. 656, 2019, pp. 691-700.
- Carayannis, E.G., Barth, T.D., and Campbell, D.F., 'The Quintuple Helix innovation model: global warming as a challenge and driver for innovation', *Journal of Innovation and Entrepreneurship*, Vol. 1, No 1, 2012, pp. 1-12.
- Cardno, *Toolkit for Monitoring and Evaluation Data Collection, Pacific Women Shaping Pacific Development*, Cardno Emerging Markets, Brisbane, 2017.
- CARE Emergency Group, *Monitoring and Evaluation Toolkit*, CARE Emergency Group, 2017. Retrieved from <https://www.careemergencytoolkit.org/management/9-monitoring-and-evaluation/>
- CLES, *Evaluating regeneration projects and programmes*, Centre for Local Economic Strategies, Manchester, 2010.
- Cohen-Shacham, E., Andrade, A., Dalton, J., Dudley, N., Jones, M., Kumar, C., Maginnis, S., Maynard, S., Nelson, C.R., Renaud, F.G., Welling, R., and Walters, G., 'Core principles for successfully implementing and upscaling Nature-based Solutions', *Environmental Science and Policy*, Vol. 98, 2019, pp. 20-29.
- Compass, *How to Develop a Monitoring and Evaluation Plan*, Springboard Compass, 2010. Retrieved from: <https://www.thecompassforsbc.org/how-to-guides/how-develop-monitoring-and-evaluation-plan>
- Connop, S., Vandergert, P., Eisenberg, B., Collier, M.J., Nash, C., Clough, J., and Newport, D., 'Renaturing cities using a regionally-focused biodiversity-led multifunctional benefits approach to urban green infrastructure', *Environmental Science and Policy*, Vol. 62, 2016, pp. 99-111.
- Creswell, J.W. and Creswell, J.D., *Research design: Qualitative, Quantitative, and Mixed Methods Approaches*, SAGE Publications, Thousand Oaks, 2018.
- Djenontin, I.N.S. and Meadow, A.M., 'The art of co-production of knowledge in environmental sciences and management: lessons from international practice', *Environmental Management*, Vol. 61, No 6, 2018, pp. 885-903.
- Dumitru, A., Frantzeskaki, N., and Collier, M., 'Identifying principles for the design of robust impact evaluation frameworks for nature-based solutions in cities', *Environmental Science and Policy*, Vol. 112, 2020, pp. 107-116.
- Dumitru, A., Tomé-Lourido, D., Young, C., Connop, S., Rhodes, M.L., Dick, G., Sermpezi, R., *Impact Assessment Guidebook: Developing robust monitoring and evaluation plans for nature-based solutions*, Connecting Nature Grant Agreement number 730222, 2021.
- Ershad Sarabi, S., Han, Q., Romme, A.G.L., de Vries, B., and Wendling, L., 'Key enablers of and barriers to the uptake and implementation of nature-based solutions in urban settings: a review', *Resources*, Vol. 8, No 3, 2019, Art. no 121.
- European Commission, *Indicative Guidelines on Evaluation Methods: Monitoring and Evaluation Indicators*, Directorate-General: The New Programming Period 2007-2013, 2006.
- Faivre, N., Fritz, M., Freitas, T., de Boissezon, B., and Vandewoestijne, S., 'Nature-Based Solutions in the EU: Innovating with nature to address social, economic and environmental challenges', *Environmental Research*, Vol. 159, 2017, pp. 509-518.
- Falco, E. and Kleinhans, R., 'Digital participatory platforms for co-production in urban development: A systematic review', *International Journal of E-Planning Research*, Vol. 7, No 3, 2019, pp. 52-79.

- Follett, R. and Strezov, V., 'An analysis of citizen science based research: usage and publication patterns', *PLoS One*, Vol. 10, No 11, 2015, Art. no e0143687.
- Frantzeskaki, N. and Kabisch, N., 'Designing a knowledge co-production operating space for urban environmental governance—Lessons from Rotterdam, Netherlands and Berlin, Germany', *Environmental Science and Policy*, Vol. 62, 2016, pp. 90-98.
- Frantzeskaki, N., McPhearson, T., Collier, M.J., Kendal, D., Bulkeley, H., Dumitru, A., Walsh, C., Noble, K., van Wyk, E., Ordóñez, C., Oke, C., and Pintér, L., 'Nature-based solutions for urban climate change adaptation: linking science, policy, and practice communities for evidence-based decision-making', *BioScience*, Vol. 69, No 6, 2019, pp. 455-466.
- Galuszka, J., 'What makes urban governance co-productive? Contradictions in the current debate on co-production', *Planning Theory*, Vol. 18, No 1, 2019, pp. 143-160.
- Geneletti, D., Zardo, L., and Cortinovis, C., 'Promoting nature-based solutions for climate adaptation in cities through impact assessment', *Handbook on biodiversity and ecosystem services in impact assessment*, Edward Elgar Publishing, Cheltenham, 2016, pp. 428-452.
- Gilfedder, M., Robinson, C.J., Watson, J.E., Campbell, T.G., Sullivan, B.L., and Possingham, H.P., 'Brokering trust in citizen science', *Society and Natural Resources*, Vol. 32, No 3, 2019, pp. 292-302.
- Kabisch, N., Frantzeskaki, N., Pauleit, S., Naumann, S., Davis, M., Artmann, M., Haase, D., Knapp, S., Korn, H., Stadler, J., Zaunberger, K., and Bonn, A., 'Nature-based solutions to climate change mitigation and adaptation in urban areas: perspectives on indicators, knowledge gaps, barriers, and opportunities for action', *Ecology and Society*, Vol. 21, No 2, 2016, Art. no 39.
- Kates, R.W., Clark, W.C., Corell, R., Hall, J.M., Jaeger, C.C., Lowe, I., McCarthy, J.J., Schellnhuber, H.J., Bolin, B., Dickson, N.M., Faucheux, S., Gallopin, G.C., Grubler, A., Huntley, B., Jäger, J., Jodha, N.S., Kasperson, R.E., Mabogunje, A., Matson, P., Mooney, H., O'Riordan, T., and Svedin, U., 'Sustainability Science', *Science*, Vol. 292, No 5517, 2001, pp. 641-642.
- Lodder, M., Allaert, K., Hölscher, K., Notermans, I., and Frantzeskaki, N., *Reflexive Monitoring Guidebook: using continuous evaluation techniques to adapt your nature-based solution planning process in real-time*, Connecting Nature Grant Agreement number 730222, 2020.
- Nesti, G., 'Co-production for innovation: the urban living lab experience', *Policy and Society*, Vol. 37, No 3, 2018, pp. 310-325.
- Pappalardo, V. and La Rosa, D., 'Policies for sustainable drainage systems in urban contexts within performance-based planning approaches', *Sustainable Cities and Society*, Vol. 52, 2020, Art. no 101830.
- Peter, M., Diekötter, T., and Kremer, K., 'Participant outcomes of biodiversity citizen science projects: a systematic literature review', *Sustainability*, Vol. 11, No 10, 2019, Art. no 2780.
- Raymond, C.M., Berry, P., Breil, M., Nita, M.R., Kabisch, N., de Bel, M., Enzi, V., Frantzeskaki, N., Geneletti, D., Cardinaletti, M., Lovinger, L., Basnow, C., Monteiro, A., Robrecht, H., Sgrigna, G., Munari, L., and Calfapietra, C., *An impact evaluation framework to support planning and evaluation of nature-based solutions projects. Report prepared by the EKLIPSE Expert Working Group on Nature-Based Solutions to Promote Climate Resilience in Urban Areas*, Centre for Ecology and Hydrology, Wallingford, 2017a.
- Raymond, C.M., Berry, P., Breil, M., Nita, M.R., Kabisch, N., de Bel, M., Enzi, V., Frantzeskaki, N., Geneletti, D., Cardinaletti, M., Lovinger, L., Basnow, C., Monteiro, A., Robrecht, H., Sgrigna, G., Munari, L., and Calfapietra, C., 'A framework for assessing and implementing the co-benefits of nature-based solutions in urban areas', *Environmental Science and Policy*, Vol. 77, 2017b, pp. 15-24.
- United Nations, *Handbook on Planning, Monitoring and Evaluating for Development Results*, United Nations, New York, 2010.
- United Nations, *Transforming our World: The 2030 Agenda for Sustainable Development*. United Nations, New York, 2015.
- van De Gevel, J., van Etten, J., and Deterding, S., 'Citizen science breathes new life into participatory agricultural research. A review', *Agronomy for Sustainable Development*, Vol. 40, No 5, 2020, pp. 1-17.
- van Mierlo, B.C., Regeer, B., van Amstel, M., Arkesteijn, M.C.M., Beekman, V., Bunders, J.F.G., de Cock Buning, T., Elzen, B., Hoes, A.C., and Leeuwis, C., *Reflexive Monitoring in action. A guide for monitoring system innovation projects*, Communication and Innovation Studies, WUR; Athena Institute, VU, Wageningen/Amsterdam, 2010.
- Wamsler, C., 'Stakeholder involvement in strategic adaptation planning: Transdisciplinarity and co-production at stake?', *Environmental Science and Policy*, Vol. 75, 2017, pp. 148-157.

- Wamsler, C., Alkan-Olsson, J., Björn, H., Falck, H., Hanson, H., Oskarsson, T., Simonsson, E., and Zelmerlow, F., 'Beyond participation: when citizen engagement leads to undesirable outcomes for nature-based solutions and climate change adaptation', *Climatic Change*, Vol. 158, No 2, 2020, pp. 235-254.
- Xing, Y., Jones, P., and Donnison, I., 'Characterisation of nature-based solutions for the built environment', *Sustainability*, Vol. 9, No 1, 2017, Art. no 149.
- Zorita, S., García-Pérez, I., Murphy-Evans, N., Rödl, A., and Barone, E., *Deliverable 4.3 Monitoring strategy in the FR interventions*, Clever Cities, Grant Agreement number 776604, 2020.

Drawing on knowledge from projects funded by the European Union

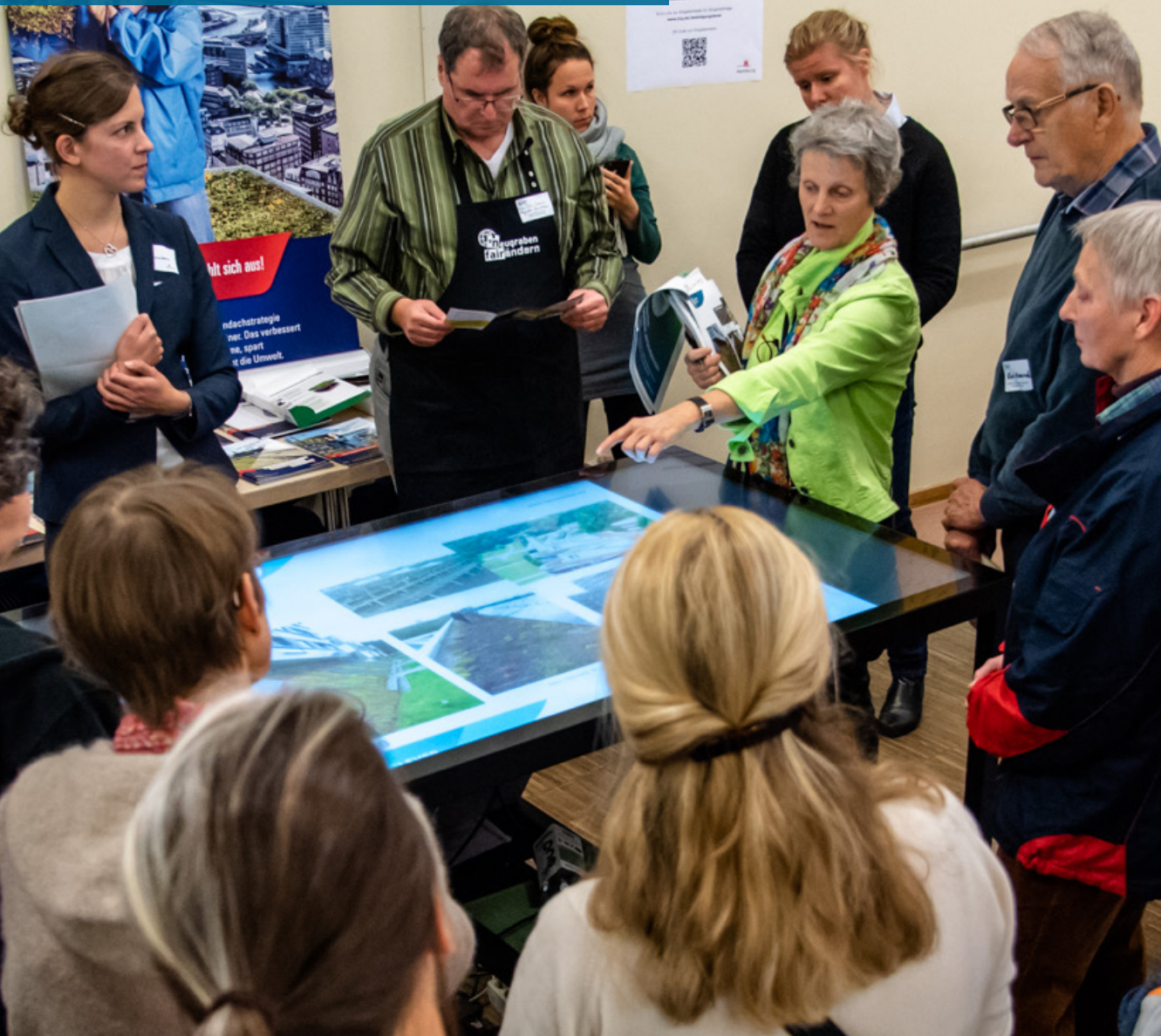

CLEVER Cities

Hamburg (DE)

London (GB)

Milan (IT)

Belgrade (RS)

Larissa (GR)

Madrid (ES)

Malmö (SE)

Sfântu Gheorghe (RO)

CLEVER Cities aims to drive a new kind of nature-based urban transformation for sustainable and socially inclusive cities across Europe, South America and China. Its local teams including citizens, businesses, knowledge partners and local authorities are co-creating nature-based interventions in Hamburg, London and Milan to regenerate cities, improve the environment, generate economic opportunities and make deprived urban districts healthier places to live. Through multi-disciplinary learning, exchange and collaboration with Fellow cities Belgrade, Larissa, Madrid, Malmö, Sfântu Gheorghe and Quito, the project is developing a CLEVER Solutions Basket with innovative technological, business, financing and governance solutions to adapt nature-based interventions for the needs of towns and cities around the world.

Approach to Impact Assessment

The decision-making process for the development of the project's monitoring framework was iterative and collaboratively designed with Front-runner cities and stakeholders involved in their local Urban Innovation Partnerships (UIPs). A first framework to guide local impact assessment processes was developed using a Theory of Change model. The second phase involved cross-comparing the Theory of Change model against the baseline data of each city, then conducting a SMART model analysis in order to prioritize the most salient themes for impact monitoring. Afterwards, Local Monitoring Plans were developed for each city based on four macro-areas of indicators, namely: environmental, human health and well-being, safety and security, and economic prosperity. For each thematic area, a performance model was developed for identifying who is doing what, how, with which tools and at what point of the project's lifetime.

Involved Stakeholders and roles

All relevant stakeholders are integrated in the process of co-defining the monitoring KPIs, including strategic leads, operational leads, technical and academic advisors and community members. A highly collaborative approach was developed between thematic experts in the project and local monitoring teams to coordinate the KPIs co-development and data gathering. By emphasizing the importance of community building, the project has created the necessary conditions for potential co-management of NBS by citizens.

Municipal Administrations

Regional/national statistics authority

Citizen

Scientists / Academia

NGOs

Schools and Kindergartens

Housing Associations

Main Challenges addressed

1. Climate Resilience

2. Water Management

3. Natural and Climate Hazards

4. Green Space Management

5. Biodiversity

6. Air Quality

7. Place Regeneration

8. Knowledge and Social Capacity Building

9. Participatory Planning and Governance

10. Social Justice and Social Cohesion

11. Health and Wellbeing

12. New Economic Opportunities & Green Jobs

Lessons learned

In order to apply Theory of Change models to monitoring processes, technical support is needed to help cities identify the outcomes and impacts that they expect from NBS. The project team found it challenging to define monitoring KPIs, especially those related to social outcomes such as health and wellbeing or social cohesion. Iterative feedback from thematic experts was required to help cities overcome this challenge. This highlights the need of including a robust scientific methodology in the process of co-defining KPIs. For urban regeneration projects that expect to monitor NBS co-benefits to well-being and health, it is key to create community-driven processes and consider stakeholders' different expectations.

Learn more
www.clevercities.eu



Drawing on knowledge from projects funded by the European Union



proGIreg

productive Green Infrastructure for post-industrial urban regeneration with and for citizens

Dortmund (DE)

Turin (IT)

Zagreb (HR)

Ningbo (CN)

Cascais (PT)

Cluj-Napoca (RO)

Piraeus (GR)

Zenica (BA)

ProGIreg uses nature for urban regeneration with and for citizens. The project is funded by the European Commission under the Horizon 2020 programme and runs from June 2018 until 2023. In proGIreg's front-runner cities' Living Labs, eight different nature-based solutions (NBS) are harnessed to create productive green infrastructure that not only helps improve living conditions and reduce vulnerability to climate change, but also provides measurable economic benefits to citizens and entrepreneurs in post-industrial urban districts. The follower cities learn from the front runners through mutual exchange and replicate successful approaches. All the work done in the Living Labs is characterized by an inclusive approach, whereby local citizens, governments, businesses, NGOs, and universities co-create the nature-based solutions together, from planning to implementation. To ensure replication beyond the project cities, proGIreg develops self-sustaining business models for nature-based solutions, based on scientific assessment of the multiple benefits they provide for social, health, ecological, and economic regeneration.

Approach to Impact Assessment

The impact of the implemented NBS is evaluated over four assessment domains: social aspects, health, environment and economy. Benefits are evaluated at both district and NBS level. At the district level, spatial data from existing administrative databases and GIS-derived data are used to evaluate indicators in the four domains all along the project, on a yearly basis. A general population survey aimed at collecting data on social, health, and economic indicators at the district level is performed before and after the implementation of the NBS and compared with analogous results obtained in a control district, having similar characteristics with respect to the Living Lab, but where no NBS (or minimal NBS) are planned. Ten tools and specific monitoring plans have been developed to monitor the impact of the single NBS (e.g., life-cycle assessments, NBS-users' questionnaires, or observational tools), taking into account cost-effectiveness and gathering comparable data.

Involved Stakeholders and roles

In proGIreg, the so-called quadruple-helix model has been adopted throughout the project, from co-design to impact evaluation. The quadruple-helix approach represents the core team in each Living Lab consisting of four key stakeholder groups: civil society (NGOs and individual citizens), academia (universities and research institutions), governmental institutions (local governments and other public authorities) and the private sector (especially SMEs). In the development of the impact evaluation, the approach has resulted in collaboration with a broad variety of actors: administrative support, coordination and data collection from local authorities; scientific support in planning and conducting the monitoring activities, and interpretation of the outcomes with academic partners; advice on the economic and innovation impact and support in data collection from the industry; social engagement and support in data collection through citizen science approaches.

Municipal Administrations

Scientists / Academia

NGOs

Green Businesses

Schools and Kindergartens

Main Challenges addressed

1. Climate Resilience

2. Water Management

3. Natural and Climate Hazards

4. Green Space Management

5. Biodiversity

6. Air Quality

7. Place Regeneration

8. Knowledge and Social Capacity Building

9. Participatory Planning and Governance

10. Social Justice and Social Cohesion

11. Health and Wellbeing

12. New Economic Opportunities & Green Jobs

Lessons learned

The planning of monitoring activities should closely involve researchers, local administration and people responsible for the data collection, since planned activities should take into account administrative barriers and availability of sufficiently trained staff. Moreover, co-designing the monitoring activity could help focusing on the real expectations of the involved population. To avoid potential pitfalls, stakeholders should get involved at an early stage, which also ensures scientific robustness and social significance of the collected data. The monitoring activities should be cost-effective in correlation with expected results. In case the implemented NBS are not suitable to produce effects that can be evaluated by the recommended indicators (for instance, because the NBS is too small or close to several other NBS), specific NBS-level tools and appropriately scaled indicators need to be developed. This will ensure data reliability, but limits cross-site comparability.

Learn more
www.progireg.eu



The proGIreg project has received funding from the European Union's Horizon 2020 innovation action programme under grant agreement no. 776528.

This work was financially supported by the National Key Research and Development Programme of China (2017YFE0119000).

EdiCitNet

Edible Cities Network: Integrating Edible City Solutions for social, resilient and sustainably productive cities

Andernach (DE) **Berlin (DE)** **Havana (CU)** **Oslo (NO)** **Rotterdam (NL)**

Carthage (TN) **Guangzhou (CN)** **Lomé (TG)** **Montevideo (UY)**

Sant Feliu de Llobregat (ES) **Šempeter-Vrtojba (SI)**

The Edible Cities Network focuses on Edible City Solutions (ECS), defined as Nature-Based Solutions related to urban food production, distribution and use. ECS can include, for example, neighbourhood gardens, bee keeping, sheep breeding, innovative distribution channels, green facades or high-tech indoor farming services, joint cooking and eating, and provision of locally produced food to shops and restaurants. The project shall demonstrate that ECS can make cities healthier, greener and more enjoyable, can create new green businesses and jobs, and can empower local communities to overcome social problems. EdiCitNet implements, monitors and transfers ECS in close cooperation with city authorities and other local stakeholders. It thereby aims to increase social, environmental and economic sustainability of cities.



Drawing on knowledge from projects funded by the European Union

Approach to Impact Assessment

A long list of potential indicators for measuring social, environmental or economic performance of ECS is provided based on an extensive review of scientific literature. Indicators that are expected to be relevant for many ECS have been included in the EdiCitNet Toolbox (developed in another work package). For more specific, detailed examples of monitoring, the EdiCitNet impact assessment takes its point of departure in the ECS that are defined in the implementation plans for the Living Labs in the Front-Runner Cities. Indicators are selected according to the expressed goals and possibly anticipated side-effects of each ECS. Methods are chosen or adapted and agreed upon under consideration of scientific soundness and human resources locally available. Data will be stored as part of the online open access EdiCitNet database developed in the EdiCitNet Toolbox.

Involved Stakeholders and roles

The EdiCitNet impact assessment team is centred around the work package “Documentation and Monitoring”. Members of the work package are city administrations of Front-Runner Cities and an interdisciplinary group of research partners from a broad variety of scientific disciplines. The city administrations are responsible for data collection in practice, either through own staff or delegated to other stakeholders, volunteers, students, ECS participants, etc. The researchers’ role is to assist the city administrations in selecting meaningful indicators, and appropriate and feasible methods for data collection and storage. Experts of different fields need to be matched with relevant cities. The scientists also facilitate dialogue among cities, and ensure that comparable data is produced in different Living Labs as far as applicable.

Municipal Administrations (FR/FL)

Citizens

Scientists / Academia

NGOs

Green businesses

Main Challenges addressed

1. Climate Resilience
2. Water Management
3. Natural and Climate Hazards
4. Green Space Management
5. Biodiversity
6. Air Quality
7. Place Regeneration
8. Knowledge and Social Capacity Building
9. Participatory Planning and Governance
10. Social Justice and Social Cohesion
11. Health and Wellbeing
12. New Economic Opportunities & Green Jobs

Lessons learned

Implementation of Edible City Solutions through co-creation can be very time-consuming, and local actors do not necessarily perceive impact assessment as a priority at an early stage. Meaningful delimitations of ECS may vary depending upon local contexts, such as geography, target group, type of produce, etc. It is of utmost importance that assessment indicators are seen to be meaningful by the local actors who are responsible for data collection. Scientists must facilitate to match intended aims of an ECS with suitable indicators, and assist stakeholders in selecting or developing methods for data collection that are both scientifically sound and feasible in the light of local personnel, knowledge, time and financial resources. Successful impact assessment further depends on ECS coordinators and participants having access to convenient tools for data collection, storage and management.

Learn more
www.edicitnet.com



Drawing on knowledge from projects funded by the European Union



URBiNAT

Urban innovative & inclusive Nature

Porto (PT)

Nantes (FR)

Sofia (BG)

Siena (IT)

Brussels (BE)

Nova Gorica (SI)

Høje-Taastrup (DK)

Khorramabad (IR)

Shenyang (CN)

URBiNAT challenges the conventional nature-based solutions definitions by not only integrating solutions inspired by nature, as the territorial and technological solutions, comprising products and infrastructures, but also including the participatory and social and economic solutions, comprising processes and services, that reinforce put their dialogue between the physical structure and the social dimension of the public space. The goal is to bring these two plans of the public space to a living interaction, building collective awareness on commonalities, both material and immaterial and, by raising the collective understanding of the human and non-human urban dimensions, promoting the co-creation, co-development, co-implementation and co-evaluation of solutions inspired by nature and in human-nature.

Approach to Impact Assessment

To analyse the effects of those implementations (and the participation process) URBiNAT measures the status quo before the participation process and after some month of use of the new clustered NBS at district level with mixed methods. (1) A Neighbourhood Survey asks about physical activity, social activity, wellbeing, health and the satisfaction/dissatisfaction with the environment at district level. A control group helps to filter out effects that are not attributable to the implemented changes. (2) Open Spaces are observed with the technique of behavioural mapping, while (3) sample measures capture environmental quality. (4) Spatial GIS analysis and statistical data complete those quantitative set of indicators. In addition, a number of qualitative methods like interviews, walkthrough and photo voice enriches the understanding of the district, the people living there and accompanies the entire process of implementation.

Involved Stakeholders and roles

In URBiNAT transdisciplinary local taskforces are implemented which are based on municipal administrations and local universities as key stakeholders. Local participation and planning experts cover the implementation process. Through Schools, kindergartens, NGOs and housing associations the connection to citizen is established and maintained. In addition, scientific expertise on the tackled challenges is brought in by academic partners within the project. Finally, linkages to regional and national statistics authorities are established by the cities to access existing data sets. Together these transdisciplinary group of stakeholders are the foundation for the local living labs in URBiNAT and ensure a flow of data for monitoring and impact evaluation. This data and it's analysis is shared within the project and beyond via the observatory platform (www.urbinatobservatory.eu).

Municipal Administrations

Regional/national statistics authority

Citizen

Planning experts

Scientists / Academia

NGOs

Schools and kindergartens

Housing associations

Main Challenges addressed

1. Climate Resilience
2. Water Management
3. Natural and Climate Hazards
4. Green Space Management
5. Biodiversity
6. Air Quality
7. Place Regeneration
8. Knowledge and Social Capacity Building
9. Participatory Planning and Governance
10. Social Justice and Social Cohesion
11. Health and Wellbeing
12. New Economic Opportunities & Green Jobs

Lessons learned

As a highly participatory innovation action URBiNAT needed to define an Impact Assessment without knowing what NBS the people living in those neighbourhoods would choose. Thus, the impact assessment strategy focused on the healthy corridor as a cluster of NBS which opened the perspective to assess the benefits for the whole district. To transform the districts into study areas which ensure an efficient flow of necessary data several hurdles have to be taken. The transdisciplinary team has to overcome barriers in language and knowledge between stakeholders. It is important to come to a common understanding and agreement on the effects of interest and a realistic timing when they will occur. There are several effects that will not be immediately visible, thus the differences between short-, middle- and long-term effects need to be taken carefully into account. It is therefore essential to allocate a realistic amount of time and resources to set up the team itself as well as to develop and conduct the impact assessment strategy before and after the implementation phase. In addition, it is important to underline the role of participatory activities which can give a perception of change and immediate benefits for the community.

Learn more
www.urbinat.eu



04

Indicators of NBS performance and impact

Appendix of Methods

What constitutes NBS monitoring?

How do I develop a robust NBS monitoring plan?

How can I execute monitoring and impact assessment activities?

What indicators of NBS impact can I use?

How do I select appropriate indicators of NBS impact?

Why is it important to evaluate the impacts of NBS?

How can I ensure NBS work for Disaster Risk Reduction?

What kinds of NBS monitoring data can I gather, and how should I manage these data?

4 INDICATORS OF NBS PERFORMANCE AND IMPACT

Coordinating Lead authors

Wendling, L., Dumitru, A.

Lead authors

Arnbjerg-Nielsen, K., Baldacchini, C., Connop, S., Dubovik, M., Feroso, J., Hölscher, K., Nadim, F., Pilla, F., Renaud, F., Rhodes, M. L., San José, E., Sánchez, R., Skodra, J., Tacnet, J.-M., Zulian, G.

Contributing authors

Allaert, K., Almassy, D., Ascenso, A., Babí Almenar, J., Basco, L., Beaujouan, V., Benoit, G., Bockarjova, M., Bode, N., Bonelli, S., Bouzouidja, R., Butlin, T., Calatrava, J., Calfapietra, C., Cannavo, P., Capobianco, V., Caroppi, G., Ceccherini, G., Chancibault, K., Cioffi, M., Coelho, S., Dadvand, P., de Bellis, Y., de Keijzer, C., de la Hera, A., De Vreese, R., Decker, S., Djordjevic, S., Dowling, C., Dushkova, D., Eiter, S., Faneca, M., Fatima, Z., Ferracini, C., Fjellstad, W., Fleury, G., Freyer, B., García, I., García-Alcaraz, M., Gerundo, C., Gil-Roldán, E., Giordano, R., Giugni, M., Goličnik Marušić, B., Gómez, S., González, M., Gonzalez-Ollauri, A., Guidolotti, G., Haase, D., Heredida, J., Hermawan, T., Herranz-Pascual, K., Jermakka, J., Jones, L., Kiss, M., Kraus, F., Körmöndi, B., Laikari, A., Laille, P., Lemée, C., Llorente, M., Lodder, M., Macinga, I., Maes, J., Maia, S., Manderscheid, M., Manzano, M., Martelli, F., Martins, R., Mayor, B., McKnight, U., Mendizabal, M., Mendonça, R., Mickovski, S.B., Miranda, A.I., Moniz, G.C., Munro, K., Nash, C., Nolan, P., Oen, A., Olsson, P., Olver, C., Ozturk, E.D., Paradiso, F., Petuccio, C., Pisani, N., Piton, G., Pugliese, F., Rasmussen, M., Ravnikar, Ž, Reich, E., Reichborn-Kjennerud, K., Rinta-Hiiro, V., Robles, V., Rodriguez, F., Roebeling, P., Ruangpan, L., Rugani, B., Rödl, A., Sánchez, I., Sánchez Torres, A., Sanesi, G., Sanz, J.M., Scharf, B., Silvestri, F., Spano, G., Stanganelli, M., Szkordilis, F., Tomé-Lourido, D., Vay, L., Vela, S., Vercelli, M., Villazán, A., Vojinovic, Z., Werner, A., Wheeler, B., Young, C., Zorita, S., Zandersen, M., zu-Castell Rüdhenhausen, M.

Summary

What is this chapter about?

This chapter introduces 12 categories of societal challenges that NBS can address (Section 4.1). These are conceptually mapped against the UN Sustainable Development Goals. For each of the 12 societal challenge areas, Section 4.2 outlines and lists indicators to evaluate the performance and impact of NBS. It reviews the different types of NBS, gives examples of each NBS type, and lists the indicators related to the particular societal challenge in a series of tables. Associated methodologies are compiled in the related Appendix of Methods. To help navigate, the indicators are classified as structural, process-based or outcome-oriented. *Structural indicators* are particularly useful during the NBS planning process and can help identify where resources may be lacking or highlight policy and/or procedural gaps that require attention. *Process-based* indicators can provide information about the value or impacts of the collaborative processes that underpin NBS (co-creation, co-implementation and co-management). The *outcome-oriented* indicators are useful to understand NBS performance by establishing an understanding of baseline (pre-NBS) conditions and following changes to these conditions after NBS implementation. We distinguish between recommended and additional indicators. Recommended indicators are considered the most important ones to monitor NBS impact. Additional indicators can provide highly valuable information, depending on local context and particular data needs. The chapter concludes with a reflection on the importance of critical thinking to select the right indicators for a holistic assessment of NBS and the development of emerging indicators (Section 4.3).

How can I use this chapter in my work with NBS?

This chapter helps to select the most appropriate indicators to assess the performance and impact of a given NBS. As resources are limited and it is simply not possible to monitor every single indicator, this buffet-style approach enables tailoring of a monitoring programme to address a specific context, both with respect to the challenges addressed and the NBS implemented in response.

When should I use this knowledge in my work with NBS?

Selection of indicators can occur at any time during the cycle of adaptive management of NBS. The initial monitoring and assessment plan identifies “must-have” outcomes that can be linked to specific indicators. For example, if the primary objective of a given NBS is to attenuate flooding then indicators related to the impacts of floods (extent of flooded land, duration of flooding, number of buildings and/or persons affected, etc.) are critical to evaluate NBS impact. During the NBS co-creation process, review of planned NBS impact indicators can help to identify potential additional benefits and inform NBS design. Indicators can be added or replaced at any time in response to observed changes or new challenges (adaptive monitoring).

How does this chapter link with the other parts of the handbook?

The previous chapters have detailed the concept of NBS and briefly described how NBS can support relevant public policies, why it is important to monitor NBS performance and evaluate their impacts, and how to develop a monitoring and evaluation strategy. This chapter focuses on which indicators to use in different local contexts in order to understand NBS performance and impacts. Chapter 4 should be read in conjunction with the Appendix of Methods, where the specific details of each indicator are further clarified, along with a brief methodology. The following Chapters 5 and 6 expand upon the list of indicators presented here by illustrating the application of selected indicators to NBS in different contexts, including NBS specifically designed for disaster risk reduction (DRR). Chapter 7 describes the different types of NBS monitoring data and provides detailed information about how to acquire and evaluate the quality these data.

4.1 Societal challenge areas addressed by NBS

The 2017 EKLIPSE Expert Working Group impact evaluation framework report (Raymond et al., 2017) identified ten challenge areas related to climate resilience in urban areas. The present report expands these original ten challenge areas to 12 separate societal challenge areas that can potentially be addressed by NBS (Figure 4-1). In addition to presenting a suite of indicators applicable to each challenge area, methods of indicator determination are presented in the separate report *Evaluating the Impact of Nature-based Solutions: Appendix of Methods* to support the application of impact indicators. The overarching objective of this *Handbook* and the accompanying *Appendix of Methods* is to provide standardized guidance and methods of indicator determination to support establishment of a robust European evidence base on NBS performance and impact. In order to compare different types of NBS, implemented in different environments and at varying scale we need to measure the same variables, using the same methods and report these outcomes using the same units of measure.

The 12 challenge areas elaborated herein are:

1. Climate Resilience
2. Water Management
3. Natural and Climate Hazards
4. Green Space Management
5. Biodiversity Enhancement
6. Air Quality
7. Place Regeneration
8. Knowledge and Social Capacity Building for Sustainable Urban Transformation
9. Participatory Planning and Governance
10. Social Justice and Social Cohesion
11. Health and Wellbeing
12. New Economic Opportunities and Green Jobs

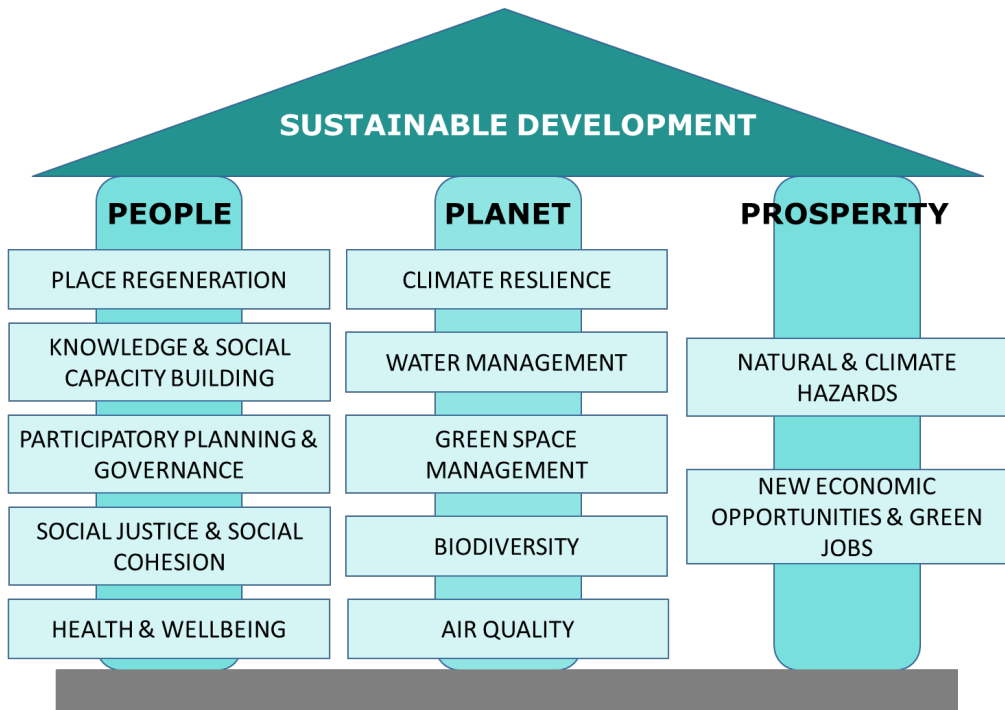

Figure 4-1. Conceptual mapping of societal challenge areas that can be addressed by NBS onto the triad of People, Planet, Prosperity pillars of sustainable development

Climate Resilience: Nature-based solutions are capable of providing resilience to the impacts of climate change through the provision of ecosystem services, and by enhancing social awareness and actions to combat climate change. The co-benefits delivered by NBS support climate change mitigation and adaptation efforts, particularly in urban areas, contributing to the liveability of cities.

Water Management: Nature-based solutions provide an excellent opportunity to address a diversity of issues associated with anthropogenic impacts on the water cycle. These include poor water quality, water availability for extraction, groundwater and surface water levels, recharging of aquifers, stormwater management, water treatment, wetland habitat management, soil water management, and ecological quality.

Natural and Climate Hazards: Risk is a combination of hazard and (negative) consequences. Nature-based solutions employed for disaster risk reduction are expected to reduce risk level (i.e., influence risk components corresponding to hazard or vulnerability). At the same time, NBS deliver further social, human, and environmental co-benefits. This challenge category was expanded based upon the further development of the “Coastal Resilience” challenge area described in the EKLIPSE Expert Working Group impact evaluation framework (Raymond et al., 2017) to include a wider array of climate-related and natural hazards.

Green Space Management: Green space management refers to the planning, establishment and maintenance of green and blue infrastructure in urban areas. Green and blue infrastructure (abbreviated as urban green infrastructure, UGI) are a type of NBS that refers specifically to the strategically managed network of natural and semi-natural ecosystems within urban boundaries. UGI provides a range of ecological and socio-economic benefits (Raymond et al., 2017) and, if correctly managed, contributes to solutions for numerous challenges such as air and noise pollution, heat waves, flooding and concerns regarding public well-being (Maes et al., 2019). NBS support the wider deployment of green and blue infrastructure (EC, 2019a; EC, 2019b), thus supporting the *EU Green Infrastructure Strategy* (EC, 2013) and the *EU Biodiversity Strategy for 2030* (EC, 2020).

Biodiversity Enhancement: Biodiversity loss and ecosystem collapse are among the greatest threats society faces in the near term. There are five primary direct drivers of biodiversity loss: changes in land and sea use, overexploitation, climate change, pollution, and invasive alien species. The link between climate change and biodiversity loss involves a feedback loop whereby climate change accelerates loss of natural capital, which is in turn a key driver of climate change. NBS support the *EU Biodiversity Strategy for 2030* (EC, 2020) through the purposeful establishment of protected areas and restoration of degraded ecosystems. The enhancement and/or conservation of biodiversity was considered as part of the Green Space Management challenge in the EKLIPSE Expert Working Group impact evaluation framework (Raymond et al., 2017). Here, we consider Biodiversity Enhancement as a separate challenge area.

Air Quality: NBS based on the creation, enhancement, or restoration of ecosystems in human-dominated environments play a relevant role in removing air pollutants and carbon dioxide, reducing the air temperature (which slows down the creation of secondary pollutants) and increasing oxygen concentration, contributing to a beneficial atmospheric composition for human life.

Place Regeneration: Urbanisation has a lasting impact on the natural environment of towns and cities, not only visible through dereliction, but also through increasing environmental footprint fuelled by economic growth and unsustainable patterns of consumption. Nature-based solutions hold the potential to contribute to the aim of ensuring successful achievement of sustainable place regeneration by way of enhancing the green space and people-nature connection, as well as using fewer environmental resources, enhancing place resilience to natural disasters, fostering collective participation and social cohesion, and improving individual wellbeing (Korkmaz and Balaban, 2020; Roberts and Sykes, 2000; Xiang et al., 2017).

Knowledge and Social Capacity Building for Sustainable Urban Transformation: Sustainable urban transformation delineates sustainable urban structures and environments, as well as radical social, economic, cultural, organizational, governmental, and physical change processes (Ernst et al., 2016; McCormick et al., 2013). Knowledge and social capacity building through educational initiatives can contribute to the complex enterprise of amassing resources for sustainable urban places. This challenge area is a new addition to

the original ten challenges described in the EKLIPSE Expert Working Group impact evaluation framework (Raymond et al., 2017).

Participatory Planning and Governance: Nature-based solutions demand approaches to planning and governance frameworks that support accessibility to green spaces, while maintaining their quality for ecosystem services provision. Urban environmental transformation is a highly complex undertaking that requires open collaborative governance and robust capacities for participatory planning. Nature-based solutions already implemented and functional across Europe have contributed a wealth of knowledge in the area of participatory planning and governance, indicating, for instance, that successful outcomes call for openness to learning and experimenting along other urban actors so as to co-create and co-maintain nature-based solutions while shaping institutional spaces in cities that allow for this co-creation, social innovation and collaboration to continue (Frantzeskaki, 2019). Significantly, open collaborative governance and participatory planning invested in nature-based solution strategies bring forward opportunities for social transformation and increased social inclusiveness in cities (Wendling et al., 2018).

Social Justice and Social Cohesion: Nature-based solutions have been linked to the notion of environmental justice across studies that explore the role of supporting urban processes involving equal access to neighbourhood green space in fostering social cohesion (e.g., bridging and bonding social capital) towards the cultural integration of typically-excluded social groups, like elderly, immigrants, persons with disabilities, etc. (i.e., recognition-based justice) (Ibes, 2015; Kweon et al., 1998; Raymond et al., 2017; Raymond et al., 2016; van Den Berg et al., 2017). Recently, Gentin et al. (2019) analysed the premises for a nature-based integration of immigrants in Europe and urged on researchers to set aside descriptions and analyses of immigrants' perceptions or use of nature, and turn their focus towards exploring and developing nature-based solutions for the purposes of social integration.

Health and Wellbeing: Critical social and environmental determinants of health, including clean air, safe drinking water, sufficient food and secure shelter, are impacted by climate change⁴⁴. More than half of the world's population lives in urban areas (towns and cities), and this number is projected to increase to two in three people by 2050⁴⁵. Climate change and other environmental issues affect all categories of population, however it is most threatening in urban areas where the majority of the population live. This means that the consequences of climate change, poor air quality and other current concerns are often very obvious and disruptive to urban living, and can affect services such as sanitation leading to public health issues.

New Economic Opportunities and Green Jobs: Key criteria of NBS are their cost-effectiveness, and their capacity to simultaneously provide environmental, social and economic benefits in support of resilience building. The adoption and implementation of NBS has the potential to create new economic opportunities

⁴⁴ <https://www.who.int/news-room/fact-sheets/detail/climate-change-and-health>

⁴⁵ <http://www.un.org/en/development/desa/news/population/world-urbanization-prospects-2014.html>

and jobs in the green sector by enabling low-carbon, resource-efficient and socially inclusive economic growth. Within this paradigm, economic growth is driven by public and private investment in activities, infrastructure and assets that support reduced emissions of carbon and pollutants, and increased energy and resource efficiency whilst enhancing biodiversity and the provision of ecosystem services.

4.2 Recommended and Additional indicators for NBS impact assessment

The NBS impact evaluation relies strongly on the adoption of quantitative and qualitative impact markers – the performance and impact indicators. These serve as means for assessing the progress of an adopted pathway targeted at achieving specific objectives, including those of various temporal and spatial scales. The Recommended indicators for each of the twelve societal challenge areas presented herein serve as a ‘starting point’ for evaluating the NBS impact, and they are considered as the primary indicators to be addressed when creating NBS monitoring and evaluation schemes. The Recommended indicators listed herein represent a foundation of performance and impact indicators to be considered for all NBS projects and that they should also provide sufficient flexibility to be applicable to all NBS scenarios.

The list of Additional indicators comprise the remaining NBS performance and impact indicators adopted by the H2020 NBS project teams involved in the production of this Handbook (see Chapter 1), and can be used to complement the list of Recommended indicators for a more holistic assessment. The selection of Additional indicators aligns with specific NBS project objectives. Some examples of Additional indicator selection are presented in the following chapter (Chapter 5).

A suite of Recommended and Additional indicators for each of the twelve identified societal challenge areas are outlined in the following sub-sections. Indicators of NBS impact have been classified as structural, process or outcome based (Donabedian, 1966) to support the selection of a suite of indicators that holistically address the process of NBS co-creation, co-implementation and co-management.

- **Structural indicators (S)** – refer to supporting infrastructure and resources in place to achieve the desired goals (people, material, policies and procedures)
- **Process indicators (P)** – refer to the efficiency, quality, or consistency of specific procedures employed to achieve the desired goals
- **Outcome indicators (O)** – refer to accomplishments or impacts

Whilst this classification does not explicitly refer to the timing of indicator use, it follows that the structural indicators may be most useful during the planning of NBS, i.e., to determine what resources or supporting policies may be needed to ensure the success of the proposed NBS action. The process indicators are useful

to evaluate the methods used to co-create, co-implement and co-manage NBS, and so can be applied throughout the adaptive management cycle but are most relevant during periods of intense activity. A large proportion of the NBS impact indicators listed herein are primarily focused on the impact or end result of NBS actions.

Note that nearly all of the indicators listed here can be used prior to NBS implementation to establish an understanding of pre-NBS, or 'baseline', conditions as well as during and following NBS actions. Comparison of pre-NBS measures with additional measurements during or following NBS implementation will show how conditions change with time. Measurements collected over time can be used to illustrate the longer-term impacts of NBS and how different outcomes are realised with time. It is important to be careful interpreting data, as not all observed changes can necessarily be directly attributed to NBS actions. In some cases the impacts of NBS may be more clear when comparing measurements taken at the same time at two different sites, i.e., the NBS site and an analogous location without NBS (a 'control site'). This is particularly important when there are multiple changes to an area or there are external influences on the system, such as significant changes to hydrologic regime from the original 'baseline' condition.

The following tables also show the applicability of each indicator to different types of NBS. Nature-based solutions can be broadly grouped based upon their primary objective or function and by the level of ecosystem intervention. The following NBS typology proposed by Eggermont et al. (2015) has been widely adopted (Figure 4-2):

- **Type 1 NBS** – minimal or no intervention in ecosystems, with objectives related to maintaining or improving delivery of ecosystem services within and beyond the protected ecosystems
- **Type 2 NBS** – extensive or intensive management approaches seeking to develop sustainable, multifunctional ecosystems and landscapes in order to improve delivery of ecosystem services relative to conventional interventions
- **Type 3 NBS** – characterised by highly intensive ecosystem management or creation of new ecosystems

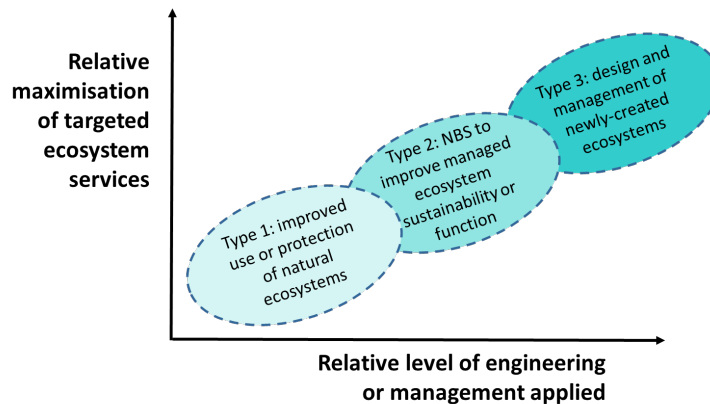

Figure 4-2. Schematic representation of NBS typology (adapted from Eggermont et al., 2015)

Type 1 NBS include protection and conservation strategies, urban planning strategies, and (environmental) monitoring strategies. Due to their nature, Type 1 NBS fall largely within the domain of governance, with implementation of Type 1 NBS strategies potentially limited or driven by a range of biophysical, social and institutional factors. Type 2 NBS are comprised of various sustainable management practices. Type 3 NBS are newly-created ecosystems, and therefore are the most “visible” solutions. **Examples** of Types 1-3 NBS may include (Cohen-Shacham et al., 2016; Eggermont et al., 2015; EC, 2015; Somarakis et al., 2019):

Type 1 NBS

- **Protection and conservation strategies**
 - Establishment of protected areas or conservation zones
 - Limitation or prevention of specific land use and/or practices
 - Ensuring of continuity of ecological networks (protection from fragmentation)
 - Maintenance or enhancement of natural wetlands
- **Urban planning strategies**
 - Ensuring of continuity of ecological network
 - Controlling urban expansion
- **Monitoring**
 - Regular monitoring of physical, chemical or biological indicators

Type 2 NBS

- **Sustainable management protocols**
 - Integrated pest/weed management
 - Spatial and/or time and frequency aspects of integrated and ecological management plans
 - Creation and preservation of habitats and shelters to support biodiversity (e.g., insect hotels for wild bees, next boxes for native bats and birds, stopover habitat/“rest stops” for migratory birds)

- Installation of apiaries
- Sustainable fertiliser use
- Control of erosion through management of grazing animal stocking density and exclusion of grazing animals from riparian areas
- Composting of organic wastes and reuse of composted material
- Integrated water resource management
- Protection of plant resources from pest and disease
- Aquifer protection from pollution and sustainable management of withdrawals

Type 3 NBS

- **Green space** - multifunctional open space characterised by natural vegetation and permeable surfaces
 - Urban parks and gardens of all sizes
 - Heritage park
 - Botanical garden
 - Community garden
 - Cemetery
 - Schoolyards and sports fields
 - Meadow
 - Green strips
 - Green transport track
 - “Multifunctional” dry detention pond or vegetated drainage basin
- **Trees and shrubs**
 - Forests (including afforestation)
 - Orchards
 - Vineyards
 - Hedges/shrubs/green fences
 - Street trees
- **Soil conservation and quality management**
 - Slope revegetation
 - Cover crops
 - Windbreaks
 - Conservation tillage practices
 - Permaculture
 - Deep-rooted perennials
 - Organic matter enrichment (manure, biosolids, green manure, compost, etc.)
 - Inorganic soil conditioners and amendments (biochar, vermiculite, etc.)
- **Blue-green space establishment or restoration**
 - Riparian buffer zones
 - Mangroves
 - Saltmarsh/seagrass
 - Intertidal habitats
 - Dune structures
- **Green built environment**
 - Green roof

- Green-blue roof
 - Green wall/façade
 - Green alley
 - Infiltration planters and tree boxes
 - Temporary and/or small-scale interventions including green furniture, green living rooms, etc.
- **Natural or semi-natural water storage and transport structures**
 - Surface wetland
 - Floodplains, floodplain reconnection with rivers
 - Restoration of degraded waterbodies
 - Restoration of degraded waterways, including re-meandering of streams and river daylighting
 - Retention pond/wet detention pond
- **Infiltration, filtration, and biofiltration structures**
 - Infiltration basin
 - Vegetated filter strip
 - Rain garden
 - Wet/dry vegetated swale, with or without check dams
 - Subsurface wetland or filtration system
 - Bioretention basin/bioretention cell

The preceding list of NBS is non-exhaustive and is intended only to provide examples of different types of NBS per the Type 1-3 classification system. The tables in this chapter indicate in general whether a particular indicator is applicable to Type 1, 2 or 3 NBS; however, the wide variety of NBS actions make consideration of all possible combinations of NBS and indicator application quite challenging. The NBS type 1-3 indicator applicability shown in the following tables should be considered a guide.

4.2.1 *Climate Resilience*

Indicators in the *Climate Resilience* challenge area primarily address:

- Direct impacts of NBS on greenhouse gas emissions via carbon storage and sequestration in vegetation and soil;
- Indirect impacts of NBS on avoided greenhouse gas emissions from various activities, through the provision of passive cooling, insulating and/or water treatment; and,
- Impacts of NBS on temperature and human comfort

Primary among the Recommended indicators for the *Climate Resilience* challenge area is carbon sequestration. Accounting for C stored in soil and vegetation, particularly in an urban area, can provide a tangible evaluation of local climate change mitigation and

the impacts of local land use, planning and decision-making. This is reflected by *the total quantity of carbon removed or stored in soil and vegetation* (indicator 1.1) as it provides a measure for direct carbon sequestration by NBS. In contrast, the *quantity of avoided greenhouse gas emissions due to reduced building consumption* (indicator 1.2) reflects the cooling and/or insulating capacity of NBS, resulting in lesser energy use for building cooling or heating.

Nature-based solutions can be an effective means to combat urban heat islands. Although NBS cannot alter the weather, the presence of (large-scale) NBS may provide sufficient cooling to locally mitigate high temperatures during heat wave events. NBS can support reduced energy use and improved thermal comfort by moderating the urban microclimate (Demuzere et al., 2014), which is reflected by *monthly mean daily maximum* (TX_x, indicator 1.3) and *minimum* (TN_n, indicator 1.4) *temperature*, which provide a measure of the local cooling or warming effect of NBS. These indicators are related both to building energy use as well as human comfort. Indicator 1.5, *heatwave incidence*, reflects prolonged periods of abnormally high temperatures, and can be used to measure the local impact of NBS on ambient temperatures during these periods,

Additional indicators are listed that can be employed to quantify specific parameters generally related to NBS-provided ecosystem services in support of climate resilience. They can further be utilised to complement the assessment of the Recommended indicators for generating a more holistic picture of the local NBS performance.

Table 4-1. Indicators related to Climate Resilience classified as structural (S), process focused (P) or outcome-based (O) indicators and their general applicability to different types of NBS

No.	Indicator	Units	Class	Applicability to NBS [†]		
				Type 1	Type 2	Type 3
RECOMMENDED						
1.1	Total carbon removed or stored in vegetation and soil per unit area per unit time	kg/ha/y	O	●	●	●
1.2	Avoided greenhouse gas emissions from reduced building energy consumption	t CO ₂ e/y	O		●	●
1.3	Monthly mean value of daily maximum temperature (TX _x)	°C	O	●		●
1.4	Monthly mean value of daily minimum temperature (TN _n)	°C	O	●		●

1.5	Heatwave incidence: Days with temperature >90 th percentile, TX90p	No./y	0	●		●
ADDITIONAL						
2.1.1 2.1.2	Total carbon stored in vegetation	kg/ha/y	0	●	●	●
2.1.3	Total leaf area	m ²	0	●	●	●
2.1.4	Carbon storage score	kg/day	0	●	●	●
2.1.5 2.1.6	Soil carbon content	ton/ha	0	●	●	●
2.1.7	Rate of soil carbon decomposition	% p.a.	0	●	●	●
2.2	Energy use savings due to NBS implementation	kWh/y	0		●	●
2.3	Carbon emissions due to building cooling	t CO ₂ e/y	0			●
2.4	Carbon emissions due to treatment of runoff water (combined sewers)	t CO ₂ e/y	0	●	●	●
2.5	Soil temperature	°C	0	●	●	●
2.6	Total surface area of wetlands	ha	0	●	●	●
2.7	Surface area of restored and/or created wetlands	ha	0	●	●	●
2.8	Aboveground tree biomass	t/ha	0	●	●	●
2.9.1	Human comfort: Universal Thermal Climate Index	°C	0	●		●
2.9.2	Thermal Comfort Score	unitless	0	●		●
2.9.3	Human comfort: Physiological Equivalent Temperature	°C	0	●		●

2.9.4	Mean or peak daytime temperature – Predicted Mean Vote-Predicted Percentage Dissatisfied	unitless	O	●		●
2.10.1	Urban Heat Island (incidence)	°C	O	●		●
2.10.2	Number of combined tropical nights and hot days	No.	O	●		●
2.10.3	Thermal Storage Score	J	O	●		●
2.10.4	Thermal Load Score	°C	O	●		●
2.11	Peak summer temperature (GI-Val)	°C	O	●		●
2.12	Maximum surface cooling	°C	O	●		●
2.13.1 2.13.2	Mean local daytime temperature	°C	O	●		●
2.13.1 2.13.2	Peak local daytime temperature	°C	O	●		●
2.14	Daily temperature range	°C	O	●		●
2.15 2.15.1 2.15.2	Air cooling	°C	O	●		●
2.16	Tree shade for local heat reduction	m ²	O	●	●	●
2.17	Rate of evapotranspiration	mm/day	O	●	●	●
2.18	Land surface temperature	°C	O	●	●	●
2.19	Surface reflectance - albedo	unitless	O	●		●
2.20	Carbon emissions from vehicle traffic	t C/y	O	●		●

[†] **Type 1 NBS** – minimal or no intervention in ecosystems, with objectives related to maintaining or improving delivery of ecosystem services within and beyond the protected ecosystems

Type 2 NBS – extensive or intensive management approaches seeking to develop sustainable, multifunctional ecosystems and landscapes in order to improve delivery of ecosystem services relative to conventional interventions

Type 3 NBS – characterised by highly intensive ecosystem management or creation of new ecosystems

4.2.2 Water Management

The diversity of potential benefits, co-benefits, and trade-offs related to NBS use for water management is reflected in the comprehensive list of Recommended indicators presented. These Recommended indicators were selected by members of a range of EU H2020 NBS projects working across urban, peri-urban, and rural areas. The Recommended list is representative of this diversity of approaches.

From the comprehensive list of Water Management indicators proposed by the H2020 NBS project teams, the list of Recommended Indicators was selected based on those that were considered to be the key drivers of nature-based solution implementation, and thus those that were relevant to the highest proportion of nature-based solution initiatives. The indicators selected as Recommended address the potential benefits, co-benefits, and trade-offs associated with changes to surface water runoff volume (3.1) and to water quality (3.2-3.6).

The Additional indicators address a wide range of applicable metrics for the assessment of NBS impact from a broad perspective, further exploring potential impacts on soil-water interactions, additional aspects of stormwater and excess runoff management, and actions pertinent to the implementation of the Water Framework Directive⁴⁶, including quantitative, hydromorphological, ecological and physico-chemical status of surface and groundwaters.

Table 4-2. Indicators related to Water Management classified as structural (S), process focused (P) or outcome-based (O) indicators and their general applicability to different types of NBS

No.	Indicator	Units	Class	Applicability to NBS [†]		
				Type 1	Type 2	Type 3
RECOMMENDED						
3.1	Surface runoff in relation to precipitation quantity	mm/%	O	●	●	●
3.2	Water quality: general urban	various	O	●	●	●
3.3	Water quality: TSS content	mg/L	O	●	●	●
3.4	Nitrogen and phosphorus concentration or load	%	O	●	●	●

⁴⁶ Directive 2000/60/EC, OJ L 327, 22.12.2000

3.5	Metal concentration or load	%	O	●	●	●
3.6	Water quality: total faecal coliform bacteria content of NBS effluents	No.	O	●	●	●
ADDITIONAL						
4.1 4.2	Infiltration rate	% or mm/h	O	●	●	●
4.1 4.2	Infiltration capacity	mm/d	O	●	●	●
4.3	Rate of evapotranspiration	mm/m ² day	O	●	●	●
4.4	Peak flow variation	%	O	●	●	●
4.5	Flood peak reduction	%	O	●	●	●
4.5	Flood peak delay	h	O	●	●	●
4.6	Height of flood peak	m ³ /s	O	●	●	●
4.6	Time to flood peak	h	O	●	●	●
4.7	Flood Excess Volume	m ³	O	●	●	●
4.8	Rainfall interception of NBS	mm/h	O	●	●	●
4.9	Runoff rate for different rainfall events	m ³ /s	O	●	●	●
4.10	Run-Off Score (ROS)	unitless	O	●	●	●
4.11	Rainfall storage capacity of NBS	mm/%	O	●	●	●
4.12	Quantitative status of groundwater	Good or Poor	O	●	●	●
4.13	Depth to groundwater	m	O	●	●	●
4.14	Chemical status of groundwater	Good or Poor	O	●	●	●

4.15	Trend in piezometric levels	m ³ /y	O	●	●	●
4.16	Groundwater Exploitation Index	%	O	●	●	●
4.17	Aquifer surface ratio with excessive nitrate	%	O	●	●	●
4.18	Aquifer surface ratio with excessive arsenic	%	O	●	●	●
4.19	Rainwater or greywater use for irrigation purposes	m ³ /y	O	●	●	●
4.20	Water Exploitation Index	%	O	●	●	●
4.21	Water dependency for food production	m ³	O	●	●	●
4.22	Calculated drinking water provision	m ³ /ha/y	O	●	●	●
4.23	Net surface water availability	m ³ /y	O	●	●	●
4.24	Volume of water removed from wastewater treatment system	m ³ /y	O	●	●	●
4.25	Volume of water slowed down entering sewer system	m ³ /s	O	●	●	●
4.26	Total surface area of wetlands	ha	O	●	●	●
4.27	Surface area of restored and/or created wetlands	ha	O		●	●
4.28	Soil water saturation	%	O	●	●	●
4.29	Soil water retention capacity	m ³ /m ³	O	●	●	●
4.30	Stemflow rate	mm/h	O	●	●	●
4.31	Percolation rate under different rainfall events	mm/d	O	●	●	●

4.32	Dissolved oxygen content of NBS effluents	mg/L	O	●	●	●
4.33	Eutrophication	unitless	O	●	●	●
4.34	pH of NBS effluents	unitless	O	●	●	●
4.35	Electrical conductivity of NBS effluents	μS/cm	O	●	●	●
4.36	Physico-chemical quality of surface waters	High, Good, Moderate, Poor, Bad	O	●	●	●
4.37	Total pollutant discharge to local waterbodies	unitless	O	●	●	●
4.38	Water quality: basic physical parameters	various	O	●	●	●
4.39	Total PAH content of NBS effluents	ng/L	O	●	●	●
4.40	Total organic carbon content of NBS effluents	mg/L C	O	●	●	●
4.41	General ecological status of surface waters	High, Good, Moderate, Poor, Bad	O	●	●	●
4.42	Ecological potential for heavily modified or artificial water bodies	Maximum, Good, Moderate, Poor, Bad	O	●	●	●
4.43	Biological quality of surface waters	High, Good, Moderate, Poor, Bad	O	●	●	●
4.44	Extended Biotic Index: total number and species richness of aquatic macroinvertebrates	unitless	O	●	●	●
4.45	Morphological Quality Index	unitless	O	●	●	●
4.46	Hydromorphological quality of surface waters	High, Good, Moderate, Poor, Bad	O	●	●	●

4.47	Fluvial Functionality Index	unitless	0	●	●	●
------	-----------------------------	----------	---	---	---	---

† **Type 1 NBS** – minimal or no intervention in ecosystems, with objectives related to maintaining or improving delivery of ecosystem services within and beyond the protected ecosystems

Type 2 NBS – extensive or intensive management approaches seeking to develop sustainable, multifunctional ecosystems and landscapes in order to improve delivery of ecosystem services relative to conventional interventions

Type 3 NBS – characterised by highly intensive ecosystem management or creation of new ecosystems

4.2.3 Natural and Climate Hazards

Indicators of NBS impact with respect to natural and climate hazards provided in this list are expected to be useful to measure the effectiveness of NBS. Application of these indicators will enable measurement of the effects of NBS on risk due to natural and climatic hazards (reduction of risk, effect on one risk component). Recommended indicators relate to three main categories and correspond to several levels of integration ranging from global policy objectives to hazard specific indicators.

Recommended indicators are more integrated and can be used to assess NBS effectiveness:

- Global policy (5.1, 5.2): These integrated indicators correspond to the way risk perception/culture is affected by the measure. Indicator 5.1 is itself the result of a lengthy assessment process and aggregation of several criteria.
- Vulnerability (5.3, 5.4, 5.5)
- Hazard and threat (5.6)

Additional indicators are mainly basic, unitary indicators primarily related to hazard intensity. They are broadly listed by types of hazard (e.g., floods, coastal erosion, landslides, water availability, and heat waves). It should be noted that this list is non-exhaustive; however, the indicators provided herein can provide the basis for a comprehensive NBS performance and impact monitoring scheme focused on evaluating NBS with respect to disaster risk.

Table 4-3. Indicators related to Natural and Climate Hazards classified as structural (S), process focused (P) or outcome-based (O) indicators and their general applicability to different types of NBS

No.	Indicator	Units	Class	Applicability to NBS [†]		
				Type 1	Type 2	Type 3
RECOMMENDED						
5.1	Disaster Resilience	unitless	S	●	●	●
5.2	Disaster-risk informed development	unitless	S	●		
5.3	Mean annual direct and indirect losses due to natural and climate hazards	€	O	●	●	●
5.4	Risk to critical urban infrastructure	%	O	●	●	●
5.5	Number of people adversely affected by natural disasters each year	unitless	O	●	●	●
5.6	Multi-hazard early warning	unitless	S	●		
ADDITIONAL						
6.1.1	Urban/residential areas exposed to risks	ha	O	●	●	●
6.1.2	Productive areas exposed to risks	ha	O	●	●	●
6.2	Natural Areas, Site of Community Importance (SCI), Special Protection Areas (SPA) exposed to risks	ha	O	●		
6.3.1	Inhabitants exposed to risks	No./ha	O	●	●	●
6.3.2	Area exposed to flood risk	ha	O	●	●	●
6.3.2	Local population exposed to flood risk	No./ha	O	●	●	●

6.3.3	Other people (workers, tourists, homes) exposed to risk	No./ha	O	●	●	●
6.3.4	Elderly, children, disabled exposed to risk	No./ha	O	●	●	●
6.4 6.4.1	Population vulnerable to risks	No./ha	O	●	●	●
6.5.1	Housing potentially exposed to risks	No.	O	●	●	●
6.5.2	Agricultural and industrial buildings potentially exposed to risks	No.	O	●	●	●
6.5.3	Strategic buildings exposed to risk	No.	O	●	●	●
6.6.1	Roads exposed to risk	m/km ²	O	●	●	●
6.6.2	Railways exposed to risk	m/km ²	O	●	●	●
6.6.3	Lifelines exposed to risk	m/km ²	O	●	●	●
6.7.1	Buildings vulnerable to risks	No./km ²	O	●	●	●
6.7.2	Transportation infrastructure and lifelines vulnerable to risks	m/km ²	O	●	●	●
6.8	Insurance against catastrophic events	%	P	●		
6.9	Flood hazard	unitless	O	●	●	●
6.10	Flooded area	ha	O	●	●	●
6.11	Height of flood peak	m ³ /s	O	●	●	●
6.11	Time to flood peak	h	O	●	●	●
6.12	Peak flow rate	m ³ /s	O	●	●	●
6.13	Peak flood volume	m ³	O	●	●	●

6.14	Flood Excess Volume	m ³	O	●	●	●
6.15	Moisture Index	unitless	O	●	●	●
6.16	Flammability Index	unitless	O	●	●	●
6.17	Soil type	unitless, qualitative	S		●	
6.18	Soil shear strength	kPa	S		●	
6.18	Soil cohesion	kPa	S		●	
6.19	Soil temperature	°C	O	●	●	●
6.20	Level of groundwater table	m below ground surface	O	●	●	●
6.21	Slope stability factor of safety	unitless	O	●	●	●
6.22	Landslide safety factor	unitless	O	●	●	●
6.23	Landslide risk – history of instability on site	unitless; binominal (yes/no)	S	●		
6.24	Occurred landslide area	%	S	●		
6.25	Landslide risk	%	O	●	●	●
6.26	Soil mass movement	kg/ha	O	●	●	●
6.27	Velocity of occurred landslide	m/s	O	●		
6.28	Erosion risk	m ³ /year	O	●	●	●
6.29	Total predicted soil loss	t/ha/y	O	●	●	●
6.30	Days with temperature >90 th percentile, TX90p	%	O	●	●	●
6.31	Warm Spell Duration Index	unitless	O	●	●	●

6.32	Heatwave incidence	No./y	O	●	●	●
6.33	Human comfort: Universal Thermal Climate Index	°C	O	●	●	●
6.34	Human comfort: Physiological Equivalent Temperature	°C	O	●	●	●
6.35	Mean or peak daytime temperature – Predicted Mean Vote-Predicted Percentage Dissatisfied	unitless	O	●	●	●
6.36	Urban Heat Island (incidence)	°C	O	●	●	●
6.37	Effective Drought Index	unitless	O	●	●	●
6.38	Standardised Precipitation Index	unitless	S	●		
6.39	Quantitative status of groundwater	Good or Poor	O	●	●	●
6.40	Trend in piezometric levels	m ³ /y	O	●	●	●
6.41	Groundwater exploitation index	%	O	●	●	●
6.42	Calculated drinking water provision	m ³ /ha/y	O	●	●	●
6.43	Water Exploitation Index	%	O	●	●	●
6.44	Net surface water availability	m ³ /y	O	●	●	●
6.45	Rainwater or greywater use for irrigation purposes	m ³ /y	O	●	●	●
6.46	Avalanche risk: Snow cover map	unitless	S	●		

[†] **Type 1 NBS** – minimal or no intervention in ecosystems, with objectives related to maintaining or improving delivery of ecosystem services within and beyond the protected ecosystems

Type 2 NBS – extensive or intensive management approaches seeking to develop sustainable, multifunctional ecosystems and landscapes in order to improve delivery of ecosystem services relative to conventional interventions

Type 3 NBS – characterised by highly intensive ecosystem management or creation of new ecosystems

4.2.4 Green Space Management

The management of UGI interventions has impact at a range of scales, from building and street level to district, urban, regional, national and transnational level. Green spaces, or UGI, are a key component of many urban planning and climate change adaptation and mitigation strategies. Related actions are included in several transnational initiatives including, for example, the EU Strategy on Green Infrastructure and the EU Biodiversity strategy (EC, 2013; EC, 2019b; EC, 2020). Section 2.2.8. *Greening urban and peri-urban areas* of the EU Biodiversity Strategy to 2030 makes explicit reference to UGI, stating: '*... This strategy aims to ... stop the loss of green urban ecosystems. The promotion of healthy ecosystems, green infrastructure and nature-based solutions should be systematically integrated into urban planning, including in public spaces, infrastructure, and the design of buildings and their surroundings*' (EC, 2020, p. 13).

Urban green spaces provide a broad range of benefits through the maintenance of ecological function and by contributing to the enhancement of biodiversity (Benedict et al., 2006; Maes et al., 2020). Strategically deployed and managed UGI can be multi-functional, providing a wide range of regulating and provisioning ecosystem services alongside a range of cultural and social values. Some of the ecosystem services provided by green space that are particularly relevant in urban areas include air quality and microclimate regulation, protection against flooding, pollination, recreation and other cultural services (Haase et al., 2014).

The quantity, quality and distribution of green-blue areas is particularly important for urban ecosystems, human well-being and social cohesion (Raymond et al., 2017; Sinnet, 2017; Tzoulas et al., 2017). The benefits provided by UGI are strongly related to other challenge areas. The objective of the Green Space Management indicators identified herein is to provide a means to assess the quantity, quality and distribution of green space within cities and their availability for citizens. Quantity and distribution of UGI are measured considering different typologies of urban green areas and using as a reference value the total surface of the city or the total population. The quality of UGI is reported using indicators related to soil, vegetation, water condition, capacity to provide local food.

The availability of UGI for citizens is measured in terms of accessibility and can be combined with other indicators to understand users' preferences and behaviours, and the availability of facilities that support nature-based activities. Numerous methods are available to evaluate green space accessibility (Handy and Niemeier, 1997; Páez et al., 2012). Herein, we propose two approaches:

- A relatively simple method that can be easily applied at district and municipal level and implements parameters recommended by the World Health Organisation (WHO, 2016; WHO, 2017); and,
- A more complex potential accessibility measure which considers the cumulative opportunities for nature based recreation and the probability to reach them according to a function of the distance (Páez et al., 2012).

Other important indicators of Green Space Management, shown herein under Additional indicators, provide an overview of urban land use intensity considering,

for example, land use types and changes, surface sealing (Maes et al., 2019) and local networks of pedestrian and bicycle paths.

Table 4-4. Indicators related to Green Space Management classified as structural (S), process focused (P) or outcome-based (O) indicators and their general applicability to different types of NBS

No.	Indicator	Units	Class	Applicability to NBS ⁺		
				Type 1	Type 2	Type 3
RECOMMENDED						
7.1	Green space accessibility	%	O	●		●
7.2	Share of green urban areas	Number (0-1)	O	●		●
7.3	Soil organic matter content	%	O	●	●	●
7.3.1	Soil organic matter index	Number (0-1)	O	●	●	●
ADDITIONAL						
8.1	Ecosystem services provision	N/A; descriptive	O	●	●	●
8.2	Annual trend in vegetation cover in urban green infrastructure	%	O			●
8.3	Edge density	m/ha	O	●		●
8.4	Public green space distribution	ha per capita	O	●		●
8.5	Distribution of blue space	%	O	●		●
8.6	Effective green infrastructure at the urban-rural interface	%	S	●		
8.7	Hot spot in peri-urban green infrastructure	%	S	●		●

8.8	Biotope Area Factor	%	0	●	●	●
8.9	Total vegetation cover	%	0	●	●	●
8.9.1	Woody vegetation cover	%	0	●	●	●
8.9.2	Non-woody vegetation cover	%	0	●	●	●
8.9.3	Total leaf area	m ²	0	●	●	●
8.10	Diversity of green space	unitless	0	●	●	●
8.11	Stages of forest stand development -Number of class diameter	No. of individuals	0	●	●	●
8.12	Tree regeneration	number	0	●	●	●
8.13	Canopy gaps	dychotomic (Yes/No)	0	●	●	●
8.14	Tree biomass stock change	t/ha/y	0	●	●	●
8.15.1	Measured soil carbon content	t/ha/y	0	●	●	●
8.15.2	Modelled carbon content	t/ha	0	●	●	●
8.15.3	Soil carbon to nitrogen ratio	unitless	0	●	●	●
8.15.4	Soil carbon decomposition rate	%	0	●	●	●
8.16	Soil matric potential	kPa	0	●	●	●
8.17	Soil temperature	°C	0	●	●	●
8.18	Soil water holding capacity	mm/cm depth	0	●	●	●
8.19.1	Plant-available water	mm/cm depth	0	●	●	●

8.19.2	Soil Available Water (SAW) for plant uptake	mm/cm depth	O	●	●	●
8.20	Vegetation wilting point	%	O		●	
8.21	Degree of soil saturation	%	O	●	●	●
8.22	Stemflow funnelling ratio	unitless	O	●	●	●
8.23	Soil erodibility	mm ³ /ha	O	●	●	●
8.24	Total predicted soil loss	t/ha/y	O	●	●	●
8.25	Soil ecotoxicological factor	Number (0-1)	O	●	●	●
8.26	Soil structure	unitless	S		●	
8.27	Soil chemical fertility/ cation exchange capacity	meq/100 g	O		●	
8.28	Flammability Index	unitless	O		●	
8.29	Community garden area	m ² per capita	O		●	●
8.30	Food production in urban allotments and NBS	t/ha/y	O		●	●
8.31	Recreational opportunities provided by green infrastructure	Interactions/week	O	●	●	●
8.31.1	ESTIMAP nature-based recreation	%	O	●	●	●
8.31.2 8.31.3	Number of visitors to recreational areas	No.	O	●	●	●
8.31.3	Purpose of visits to recreational areas	unitless	O	●	●	●
8.31.4	Frequency of use of green and blue spaces	h/week	O	●	●	●

8.31.5	Activities allowed in recreational areas	No.	S	●		
8.32	Visual access to green space	Number (0-4)	O	●		●
8.32	Time spent viewing green space from residence each day	Number (0-3)	O	●		●
8.32.1	Viewshed	km ²	O	●		●
8.32	Satisfaction with green and blue spaces	Number (1-5)	O	●	●	●
8.34	Betweenness centrality	unitless	O	●		●
8.35	Proportion of road network dedicated to pedestrians and/or bicyclists	%	S	●		
8.35.1	New pedestrian, cycling and horse paths	km	O	●		●
8.35.2	Sustainable transportation modes allowed	Number	S	●		
8.36	Links between urban centres and NBS	Number	S	●		
8.37	Walkability	Number	O	●	●	●
8.38	Land composition	% use class A, N, D, M	O	●		●
8.39	Land use change and green space configuration	various	O	●		●
8.40	Soil sealing	%	O	●		●
8.41	Ambient pollen concentration	Number	O	●	●	●

[†] **Type 1 NBS** – minimal or no intervention in ecosystems, with objectives related to maintaining or improving delivery of ecosystem services within and beyond the protected ecosystems

Type 2 NBS – extensive or intensive management approaches seeking to develop sustainable, multifunctional ecosystems and landscapes in order to improve delivery of ecosystem services relative to conventional interventions

Type 3 NBS – characterised by highly intensive ecosystem management or creation of new ecosystems

4.2.5 Biodiversity Enhancement

The fragmentation of green space is a significant impact of urbanisation and can reduce intra- and inter-species connectivity, leading to a loss of biodiversity. Thus, the *structural and functional connectivity of natural areas (green and blue spaces)* are key among Recommended indicators of biodiversity (indicators 9.1.1 and 9.1.2). Several indicators are recommended related to the *presence of native non-native or alien invasive species* (e.g., 9.2, 9.3 and 9.3.1). These indicators strongly support biodiversity initiatives focused on the re-introduction or maintenance of local fauna and flora.

Both the *Shannon Diversity Index (9.4)* and *Shannon Evenness Index (9.5)* are recommended indicators of biodiversity. The Shannon Diversity Index is commonly used to evaluate species diversity within a defined area. Whilst the Shannon Diversity Index does not qualify whether the species present are native, non-native or alien invasive, it accounts for the number of different species observed within a given space and their relative abundances. The Shannon Evenness Index provides information about the relative number of individuals of each species in a given area.

Numerous additional indicators of biodiversity can support evaluation of the complexity and multidimensionality of local ecosystems in order to underpin spatial planning, prioritise sites for interventions and assess the impacts of NBS initiatives on existing green networks.

Table 4-5. Indicators related to Biodiversity Enhancement classified as structural (S), process focused (P) or outcome-based (O) indicators and their general applicability to different types of NBS

No.	Indicator	Units	Class	Applicability to NBS [†]		
				Type 1	Type 2	Type 3
RECOMMENDED						
9.1 9.1.1	Structural connectivity of urban green and blue spaces	various	O	●		●
9.1 9.1.2	Functional connectivity of urban green and blue spaces	various	O	●	●	●
9.2	Number of native species	Number	O	●	●	●
9.3	Number of non-native species introduced	Number	O	●	●	●
9.3.1	Number of invasive alien species	Number	O	●	●	●

9.4	Species diversity within a defined area	Number	O	●	●	●
9.5	Number of species within a defined area	Number	O	●	●	●
ADDITIONAL						
10.1	Proportion of natural areas within a defined urban zone	%	O	●		●
10.2	Area of habitats restored	ha	O	●	●	●
10.3	Shannon Diversity Index of habitats	Number (unitless)	O	●	●	●
10.3.1	Abundance of ecotones/ Shannon diversity	unitless	O	●	●	●
10.4	Length of ecotones	km	O	●	●	●
10.5	Publicly accessible green space connectivity	%	O	●	●	●
10.6	Ecological integrity	%	O	●	●	●
10.7	Proportion of protected areas	%	O	●		
10.7.1	Sites of community importance and special protection areas	ha	O	●		
10.7.2	Article 17 habitat richness	No./grid	O	●	●	●
10.8	Number of veteran trees per unit area	No./ha	O	●	●	●
10.9	Quantity of dead wood per unit area	m ³ /ha	O	●	●	●
10.10	Forest habitat fragmentation – effective mesh density	1/ha	O	●	●	●
10.11	Extent of habitat for native pollinator species	ha	O	●	●	●

10.12	Polluted soils	ha	O		●	●
10.13	Food web stability	unitless	O	●	●	●
10.14	Carbon and nitrogen cycling in soil	t/ha/y	O	●	●	●
10.15	Equivalent used soil	m ³	O			●
10.16	Number of conservation priority species	No.	O	●	●	●
10.17	Article 17 species richness	No./grid	O	●	●	●
10.18	Number of native bird species within a defined urban area	No./ha	O	●	●	●
10.19	Species diversity - general	No.	O	●	●	●
10.19.1	City Biodiversity Index	%	O	●	●	●
10.20	Bird species richness	No./grid	O	●	●	●
10.21	Animal species potentially at risk	No./ha	O	●	●	●
10.22	Typical vegetation species cover	%	O	●	●	●
10.23	Pollinator species presence	No./ha or %	O	●	●	●
10.24	Biodiversity conservation	various	O	●	●	●
10.25	Metagenomic mapping	unitless	O	●	●	●
10.25.1	Abundance of functional groups	Number (unitless)	O	●	●	●
10.25.2	Diversity of functional groups	Number (unitless)	O	●	●	●
10.25.3	Diversity of functional groups	Number (unitless)	O	●	●	●

† **Type 1 NBS** – minimal or no intervention in ecosystems, with objectives related to maintaining or improving delivery of ecosystem services within and beyond the protected ecosystems

Type 2 NBS – extensive or intensive management approaches seeking to develop sustainable, multifunctional ecosystems and landscapes in order to improve delivery of ecosystem services relative to conventional interventions

Type 3 NBS – characterised by highly intensive ecosystem management or creation of new ecosystems

4.2.6 Air Quality

A number of factors threaten the quality of life in European cities and in most of the world. The drivers include increasing pollution levels, urban heat islands, flooding and extreme events related to climate change, as well as decreased biodiversity (Grimm et al., 2008). These can have detrimental effects for human health and well-being.

Air quality is a major concern worldwide, particularly in urban areas, due to its direct consequences on **human health, plants, animals, infrastructure and historical buildings** (among others). In the political agenda, air quality issues can be coupled with climate change mitigation policies, since many actions aimed at air quality improvement involve a concurrent reduction of greenhouse gas (GHG) emissions. This is the case, for example, of reductions of fossil fuel combustion since its derived emissions contain CO₂ and other GHGs and pollutants directly affecting human health. Nevertheless, measures to improve urban air quality and mitigate climate change tend to be considered separately even though many pollutants affect both environmental impacts.

The emission of the traditional air quality pollutants (AQPs) either direct or indirectly as a result of atmospheric chemistry, affect the concentrations of several climate pollutants. At the same time, the increase of air temperature due to global warming affects the concentrations of the AQPs. Some AQPs, such as ozone (O₃), are also GHGs. These interactions between them are complex and can both enhance and mitigate global warming. Accordingly, a large number of abatement measures are beneficial for mitigating both impacts; however, there are some measures that may be beneficial for mitigating climate change but increase emissions of the key urban air pollutants, or vice versa.

Policies to reduce climate change and improve urban air quality have generally been considered in isolation, with more importance being paid to the mitigation of climate change than to urban air quality over recent years. In the long term, large reductions in both AQPs and GHGs are necessary to mitigate climate change and improve public health. Therefore, priority should be given to measures where there are clear co-benefits such as energy conservation measures. However, large emissions reductions from this type of measures can be difficult to achieve and there will continue to be a need to use legislation to force the adoption of low AQP emitting technologies despite some CO₂ penalties.

Fuel switching to renewable fuels offers a huge potential for co-benefits, with only biomass and biofuels being problematic in terms of indirect GHG emissions from land use changes and higher emissions of particulate matter (PM) from solid biomass and gaseous pollutants from some liquid biofuel blends (Querol et al., 2016).

Air pollution is a local, pan-European and hemispheric issue. Air pollutants released in one country may be transported in the atmosphere, contributing to or resulting in poor air quality elsewhere.

Particulate matter, nitrogen dioxide and ground-level ozone, are now generally recognised as the three pollutants that most significantly affect **human**

health. Long-term and peak exposures to these pollutants range in severity of impact, from impairing the respiratory system to premature death. Around 90% of city dwellers in Europe are exposed to pollutants at higher concentrations than the air quality levels deemed harmful to health. For example, fine particulate matter (PM_{2.5}) in air has been estimated to reduce life expectancy in the EU by more than eight months. European Union legislation sets both short-term (hourly/daily) and long-term (annual) air quality standards⁴⁷ (Directive 2008/50/EU). This is reflected in and addressed by the Recommended indicators (11.1–11.3).

Air pollution also **damages our environment.** Problems such as acidification was substantially reduced between 1990 and 2010 in Europe's sensitive ecosystem areas that were subjected to acid deposition of excess sulphur and nitrogen compounds. Less progress was made in environmental problematics such as eutrophication, which is caused by the input of excessive nutrients into ecosystems. The area of sensitive ecosystems affected by excessive atmospheric nitrogen diminished only slightly between 1990 and 2010. High ozone concentrations also cause crop damage is caused. Most agricultural crops are exposed to ozone levels that exceed the EU long-term objective intended to protect vegetation. This notably includes a significant proportion of agricultural areas, particularly in southern, central and eastern Europe.

The Additional indicators of Air Quality focus more specifically on ambient air pollutant concentration, and the related aspects, such as pollutant removal by vegetation and associated health aspects.

Table 4-6. Indicators related to Air Quality classified as structural (S), process focused (P) or outcome-based (O) indicators and their general applicability to different types of NBS

No.	Indicator	Units	Class	Applicability to NBS [†]		
				Type 1	Type 2	Type 3
RECOMMENDED						
11.1	Number of days during which ambient air pollution concentrations in the proximity of the NBS (PM _{2.5} , PM ₁₀ , O ₃ , NO ₂ , SO ₂ , CO and/or PAHs expressed as concentration of benzo[a]pyrene) exceeded threshold	No. of days	O	●	●	●

⁴⁷ <http://ec.europa.eu/environment/air/quality/standards.htm>;
http://ec.europa.eu/environment/basics/health-wellbeing/noise/index_en.htm

	values during the preceding 12 months					
11.2	Proportion of population exposed to ambient air pollution (PM _{2.5} , PM ₁₀ , O ₃ , NO ₂ , SO ₂ , CO and/or PAHs expressed as concentration of benzo[a]pyrene) in excess of threshold values during the preceding 12 months	%	0	●	●	●
11.3	European Air Quality Index	Good, Fair, Moderate, Poor, Very Poor, Extremely Poor	0	●	●	●
ADDITIONAL						
12.1	Removal of atmospheric pollutants by vegetation (leaves, stems and roots)	kg/ha/y	0	●	●	●
12.2	Total particulate matter removed by NBS vegetation	kg/ha/y	0	●	●	●
12.3	Modelled O ₃ , SO ₂ , NO ₂ and CO capture/removal by vegetation	kg/ha/y	0	●	●	●
12.3.1	Total leaf area	m ²	0	●	●	●
12.4	NO _x and PM in gaseous releases	PM- µg/m ³ NO _x - ppb	0			●
12.5	Ambient pollen concentration	Number	0	●	●	●
12.6	Trends in emissions of NO _x and SO _x	µg/m ³	0	●	●	●
12.7	Concentration of particulate matter (PM ₁₀ and PM _{2.5}), NO ₂ , and O ₃ in ambient air	µg/m ³	0	●	●	●

12.8	Concentration of particulate matter (PM _{2.5} and PM ₁₀) at respiration height along roadways and streets	µg/m ³	O	●	●	●
12.9	Mean level of exposure to ambient air pollution	µg/m ³	O	●	●	●
12.10	Morbidity due to poor air quality	No./y	O	●	●	●
12.10	Mortality due to poor air quality	No./y	O	●	●	●
12.10	Years of Life Lost due to poor air quality	y	O	●	●	●
12.11	Avoided costs for air pollution control measures	€	O	●	●	●

[†]**Type 1 NBS** – minimal or no intervention in ecosystems, with objectives related to maintaining or improving delivery of ecosystem services within and beyond the protected ecosystems

Type 2 NBS – extensive or intensive management approaches seeking to develop sustainable, multifunctional ecosystems and landscapes in order to improve delivery of ecosystem services relative to conventional interventions

Type 3 NBS – characterised by highly intensive ecosystem management or creation of new ecosystems

4.2.7 Place Regeneration

Urban expansion and growth bring countless opportunities and challenges for cities, rendering place regeneration a significant priority while bringing the notions of environmental quality and sustainable development to the forefront. Urban regeneration is seen as a response to the forces pressuring cities to adapt by addressing decline and increasing the resources for sustainable growth. Urban regeneration reflects a comprehensive and integrated vision and action which leads to the resolution of urban problems and which seeks to bring about a lasting improvement in the economic, physical, social and environmental condition of an area that has been subject to change (Roberts and Sykes, 2000).

In line with the state-of-the-art in the field of sustainable place regeneration, all indicators listed here – both recommended and Additional - should be analysed and applied with consideration for the specific context that defines regeneration actions at city level, at any given time, the history of a city or area, previous nature-based initiatives and their impact, as well as other particular issues and opportunities presented by a town or city.

Table 4-7. Indicators related to Place Regeneration classified as structural (S), process focused (P) or outcome-based (O) indicators and their general applicability to different types of NBS

No.	Indicator	Units	Class	Applicability to NBS [†]		
				Type 1	Type 2	Type 3
RECOMMENDED						
13.1	Derelict land reclaimed for NBS	ha	O			●
13.2	Quantity of blue-green space (as a ratio to built form)	Number (0-1)	O	●		●
13.3	Perceived quality of urban blue-green spaces (accessibility, amenities, natural features, incivilities and recreational facilities)	various	O	●		●
13.4	Place attachment: Place identity or "sense of place"		O	●	●	●
13.5	Recreational value of public green space	various	O	●	●	●
13.6	NBS incorporated in building design / incorporation of environmental design in buildings	Number (0-5)	P			●
13.7	Cultural heritage protection	Number (0-5)	P	●		
ADDITIONAL						
14.1	Share of green urban areas	%	O	●		●
14.2	Land composition	% use class A, N, D, M	O	●	●	●
14.3	Land take index	%	O			●
14.4	Area devoted to roads	Number (0-1)	O	●		●

14.5	Traditional knowledge and uses reclamation	Yes/No	O	●	●	●
14.6	Traditional events organised in NBS areas	No.	O	●		●
14.7	Social active associations	No.	S	●	●	●
14.8	Direct economic activity: Retail and commercial activity in proximity to green space	%	O	●		●
14.9	Direct economic activity: Number of new businesses created and gross value added to local economy	No. of businesses and €	O	●		●
14.10	Social return on investment	€/€	O			●
14.11	Population mobility	%	O	●	●	●
14.12	Population growth	%	O	●	●	●
14.13	Proportion of elderly residents	%	O	●	●	●
14.14	Areal sprawl	m ² /m ²	O	●		
14.15	Access to public amenities	various	O	●		●
14.16	Average distance of natural resources from urban centres/ train station/ public transport	km	O	●		●
14.17	Natural and cultural site availability	km ²	O	●		●
14.18	Historical and cultural meaning	unitless	O	●	●	●
14.19	Cultural value of blue-green spaces	various	O	●		●
14.20	Opportunities for tourism	No./year	O	●		●

14.21	Building structure – Urban form	Dimensionless (0-140)	P	●		
14.22	Material used coherence	Yes/No	P			●
14.23	Techniques used coherence	Yes/No	P			●
14.24	Design for sense of place	Number (0-5)	P	●		●
14.25	Viewshed	km ²	O	●		●
14.26	Scenic routes and landmarks created	No.	O	●		●
14.27	Scenic paths created	km	O	●		●

† **Type 1 NBS** – minimal or no intervention in ecosystems, with objectives related to maintaining or improving delivery of ecosystem services within and beyond the protected ecosystems

Type 2 NBS – extensive or intensive management approaches seeking to develop sustainable, multifunctional ecosystems and landscapes in order to improve delivery of ecosystem services relative to conventional interventions

Type 3 NBS – characterised by highly intensive ecosystem management or creation of new ecosystems

4.2.8 Knowledge and Social Capacity Building for Sustainable Urban Transformation

Environmental education opportunities are envisioned as a significant indicator of urban resources for associational involvement in nature-based solutions, and of communal contexts for building trust. Although not all environmental education programs have the potential to generate social capital among participants (e.g., classroom instruction), there are forms that can foster social connectivity, trust, and associational and volunteer involvement. Examples of such programs include those that incorporate collective opportunities for volunteer and associational involvement around stewardship, like community gardening and tree planting, or those that incorporate opportunities for intergenerational learning and collective decision-making, like place-based learning, school-community partnership for sustainability, environmental action, action competence, community-based natural resource management, social-ecological systems resilience) (Krasny et al., 2015).

The Recommended indicators listed here have been extensively researched as significant dimensions playing a role in green and pro-environmental behaviour, NBS impact, and foreseeable sustainability (Derr, 2017; Hedefalk et al., 2015; Kudryavtsev et al., 2012; Varela-Candamio et al., 2018). The Additional indicators provide further the means and methods to explore various dimensions of sustainable urban societal transformation.

Table 4-8. Indicators related to Knowledge and Social Capacity Building for Sustainable Urban Transformation classified as structural (S), process focused (P) or outcome-based (O) indicators and their general applicability to different types of NBS

No.	Indicator	Units	Class	Applicability to NBS [†]		
				Type 1	Type 2	Type 3
RECOMMENDED						
15.1	Citizen involvement in environmental education activities	No. of people	O	●	●	●
15.2	Social learning regarding ecosystems and their functions	Qualitative data (dimensionless)	O	●	●	●
15.3	Pro-environmental identity		O	●	●	●
15.4	Pro-environmental behaviour	Number (0-168)	O	●	●	●
ADDITIONAL						
16.1	Children involved in educational activities	No./y	O	●	●	●
16.2	Engagement with NBS sites and projects	Qualitative data (dimensionless)	P	●	●	●
16.3	Mindfulness	Number (0-3)	O	●	●	●
16.4	Proportion of schoolchildren involved in gardening	%	O			●
16.5	Citizens' awareness regarding urban nature and ecosystem services	Number (0-5)	O	●	●	●
16.6	Green intelligence awareness	No. activities; No. attendees; No. publications	O	●	●	●
16.7	Positive environmental		S, O	●	●	●

	attitudes motivated by contact with NBS					
16.8	Urban farming educational and/or participatory activities	Qualitative data (dimensionless)	0		●	●

[†]**Type 1 NBS** – minimal or no intervention in ecosystems, with objectives related to maintaining or improving delivery of ecosystem services within and beyond the protected ecosystems

Type 2 NBS – extensive or intensive management approaches seeking to develop sustainable, multifunctional ecosystems and landscapes in order to improve delivery of ecosystem services relative to conventional interventions

Type 3 NBS – characterised by highly intensive ecosystem management or creation of new ecosystems

4.2.9 Participatory Planning and Governance

The implementation and scaling of nature-based solutions requires new forms of planning and governance approaches. In particular, nature-based solutions’ planning and governance need to embrace experimental approaches for innovation and continuous learning, institutional space for cross-sectoral dialogue and collaboration and citizen participation (Davies and Laforteza, 2019; Frantzeskaki et al., 2019; Kabisch et al., 2017). Citizen participation in environmental decision-making is extremely valuable, underscoring the importance of careful consideration of dynamic participation processes through all the stages of an urban greening project in order to harness the individual and collective empowering potential of participatory practices (Feldman and Westphal, 2000). Participatory planning and governance are advocated to enhance social, political and financial support of the nature-based solution (EC, 2016; Frantzeskaki and Kabisch, 2016; Pauleit et al., 2017).

The recommended indicators capture these cardinal dimensions and processes, paving the way for a dynamic assessment framework that accounts for processual variables (e.g., empowerment, trust in decision-making) as well as changes in existing planning and governance approaches (e.g., new partnerships and policy learning) (see also Calliari et al., 2019). The additional indicators further explore relevant participatory processes by examining citizen/stakeholder participation in NBS planning and implementation, additionally considering the involvement of under-represented groups. Further dimensions of innovative governance and financing actions can be explored alongside the adoption of the climate resilience strategies that highlight the importance of integrated approaches and stakeholder involvement.

Table 4-9. Indicators related to Participatory Planning and Governance classified as structural (S), process focused (P) or outcome-based (O) indicators and their general applicability to different types of NBS

No.	Indicator	Units	Class	Applicability to NBS [†]		
				Type 1	Type 2	Type 3
RECOMMENDED						
17.1	Openness of participatory processes	Number (1-5)	P	●	●	●
17.1.1	Proportion of citizens involved in participatory processes	%	P	●	●	●
17.2	Sense of empowerment: perceived control and influence over decision-making		O	●	●	●
17.3	Adoption of new forms of participatory governance: PPPs activated	No.	O	●	●	●
17.4	Policy learning for mainstreaming NBS: Number of new policies instituted	No.	S	●	●	●
17.5	Trust in decision-making procedure and decision-makers	Number (1-5)	O	●	●	●
ADDITIONAL						
18.1	Community involvement in planning	Number (0-5)	P	●	●	●
18.1.1	Citizen involvement in co-creation/ co-design of NBS	No.	P			●
18.1.2	Stakeholder involvement in co-creation/ co-design of NBS	No.	P			●
18.2	Community involvement in implementation	Number (0-5)	P		●	●

18.3	Involvement of citizens from traditionally under-represented groups	Number (0-5)	P	●	●	●
18.4	Active engagement of citizens in decision-making	%	P	●	●	●
18.5	Consciousness of citizenship	Number (0-5)	O	●	●	●
18.6	Number of governance innovations adopted	Number (0-5)	S	●	●	●
18.7	Adoption of new forms of NBS (co-)financing	Number (0-5)	O	●	●	●
18.8	Development of a climate resilience strategy (extent)	Number (0-7)	O	●	●	●
18.9	Alignment of climate resilience strategy with UNISDR-defined elements	Number (0-5) across 117 categories	O	●	●	●
18.10	Adaptation of local plans and regulations to include NBS	Number (0-5)	O	●	●	●
18.11	Perceived ease of governance of NBS	Number (0-5)	O	●	●	●
18.12	Diversity of stakeholders involved	%	P	●	●	●
18.13	Transparency of co-production	Number (1-5)	P	●	●	●
18.14	Activation of public-private collaboration	No.	O	●	●	●
18.15	Reflexivity: identified learning outcomes	No.	P	●	●	●
18.16	Facilitation skills for co-production	Number (1-5)	P	●	●	●
18.17	Procedural fairness	Number (1-5)	P	●	●	●
18.18	Strategic alignment	Number (1-5)	P	●	●	●

18.19	Reflexivity: time for reflection	No.	P	●	●	●
-------	----------------------------------	-----	---	---	---	---

† **Type 1 NBS** – minimal or no intervention in ecosystems, with objectives related to maintaining or improving delivery of ecosystem services within and beyond the protected ecosystems

Type 2 NBS – extensive or intensive management approaches seeking to develop sustainable, multifunctional ecosystems and landscapes in order to improve delivery of ecosystem services relative to conventional interventions

Type 3 NBS – characterised by highly intensive ecosystem management or creation of new ecosystems

4.2.10 Social Justice and Social Cohesion

Social cohesion has been long proved to represent an important resource for long-term environmental sustainability in that socially cohesive communities tend to be more supportive of environmentally sustainable attitudes and behaviours compared with those communities where social cohesiveness is weaker (Uzzell et al., 2002). Bridging social capital's (indicator 19.1.1) impact on collective initiatives like nature-based solutions can be far-reaching, as it allows different groups to share and exchange information, ideas and innovation and builds consensus among the groups representing otherwise diverse interests. Conversely, bonding social capital (indicator 19.1.2) fulfils an important social function by providing the norms and trust that facilitate the kind of collaborative action required by initiatives like NBS.

Trust, solidarity, tolerance, and respect are generally understood as manifestations of a cohesive society, one that works towards the well-being of all the members, that is, towards the common good. While the benefits of communitarian social capital depend upon basic structural factors (of which inequality, level of education of the population and its ethnic-racial composition are considered most important), trust, solidarity, tolerance, and respect (indicators 19.3-19.5) are cardinal dimensions of the process of creating or building social capital which enables people to expect good from others (reciprocity) and to act on behalf of others in order to create a better future for all (Cloete, 2014).

Moreover, whilst good governance has a significant impact on social cohesion by increasing trust, tolerance, and acceptance of diversity, creating trust and guaranteeing reciprocity through concurrent values and abiding to norms that guide the process of participation in networks are, in fact, acts that fall into the realm of individual responsibility. It seems that people with values like honesty, trustworthiness, integrity, who care for their fellow humans, are likely to create social capital that could lead to the formation of public good (Cloete, 2014). Therefore, trust, solidarity, tolerance, and respect are considered fundamental resources in the inception, implementation, and potential success of any collective initiatives like nature-based solutions.

All things considered, the Recommended indicators included here address the main dimensions pertinent to state-of-the-art research of nature-based solution and their role in creating social capital and fostering global priorities oriented

towards social cohesion and social justice. The Additional indicators focus on the supplementary details, including perceived social interactions, safety and inclusion, and crime.

Table 4-10. Indicators related to Social Justice and Social Cohesion classified as structural (S), process focused (P) or outcome-based (O) indicators and their general applicability to different types of NBS

No.	Indicator	Units	Class	Applicability to NBS [†]		
				Type 1	Type 2	Type 3
RECOMMENDED						
19.1.1	Bridging– quality of interactions within and between social groups		O	●	●	●
19.1.2	Bonding – quality of interactions within and between social groups		O	●	●	●
19.2	Inclusion of different social groups in NBS co-co-co processes	Number (0-5)	P	●	●	●
19.3	Trust within the community		O	●	●	●
19.4	Solidarity among neighbours		O	●	●	●
19.5	Tolerance and respect		O	●	●	●
19.6	Availability and equitable distribution of blue-green space	map	O	●	●	●
ADDITIONAL						
20.1	Linking social capital		O	●	●	●
20.2	Perceived social interaction	Number (0-5) across 4 categories	O	●	●	●
20.3	Quantity and quality of social interaction	Frequency	O	●	●	●

20.4.1	Perception of socially supportive network	Number (0-5) across 5 categories	0	●	●	●
20.4.2	Perceived social support	Number (0-4)	0	●	●	●
20.5	Perceived social cohesion	Number (0-4)	0	●	●	●
20.6	Perceived ownership of space and sense of belonging to the community	Number (0-5) across 2 categories	0	●	●	●
20.7	Proportion of community who volunteer	Number (0-5)	0		●	●
20.8	Proportion of target group reached by an NBS project	%	0	●	●	●
20.9	Perceived personal safety	Number (0-5)	0	●	●	●
20.10	Perceived safety of neighbourhood		0	●	●	●
20.11	Number of violent incidents, nuisances and crimes per 100 000 population	No. per 100 000	0	●	●	●
20.12	Realised safety		0	●	●	●
20.13	Area easily accessible for people with disabilities	km ²	0	●	●	●
20.14	Change in property incomes	%	0	●	●	●

[†] **Type 1 NBS** – minimal or no intervention in ecosystems, with objectives related to maintaining or improving delivery of ecosystem services within and beyond the protected ecosystems

Type 2 NBS – extensive or intensive management approaches seeking to develop sustainable, multifunctional ecosystems and landscapes in order to improve delivery of ecosystem services relative to conventional interventions

Type 3 NBS – characterised by highly intensive ecosystem management or creation of new ecosystems

4.2.11 Health and Wellbeing

The effects of climate change, such as heatwaves, lead to urban areas becoming increasingly uncomfortable, with vulnerable members of society feeling such impacts

the most⁴⁸. In the heat wave of summer 2003 in Europe for example, more than 70 000 excess deaths were recorded (Robine et al., 2008).

High temperatures also raise the levels of ozone and other pollutants in the air that exacerbate cardiovascular and respiratory disease⁴⁹. Air quality (see section 4.2.6) is also a major concern worldwide, particularly in urban areas, due to its direct consequences on human health, plants, animals, infrastructure and historical buildings (among others). Increasing evidence supports the idea that ecological features such as the diurnal cycles of light and day, sunlight exposure, seasons, and geographic characteristics of the natural environment such as altitude, latitude, and green spaces are important determinants of cardiovascular health and cardiovascular disease (CVD) risk (Bhatnagar, 2017). Some of the beneficial cardiovascular effects of greenery might relate to a decrease in the levels of local air pollution, increased proximity to walking spaces, or lower levels of mental stress (Bhatnagar, 2017). With an abundance of convenient, palatable, energy dense foods and increasingly fewer demands for physical activity in usual lifestyles, the contemporary environment enables the energy balance to be tipped in favour of weight gain (obesogenic environment) (Bhrem and D'Alessio, 2014). In adults, obesity is associated with increasing risk of cardiovascular disease, type 2 diabetes, and all-cause mortality. Most of the associated mortality and morbidity is mediated through major chronic diseases related to obesity, such as cardiovascular disease, diabetes, and cancer (Bhrem and D'Alessio, 2014). Overweight children face a greater risk of a host of problems, including type 2 diabetes, high blood pressure, high blood lipids, asthma, sleep apnoea, chronic hypoxemia (too little oxygen in the blood), early maturation, and orthopaedic problems (Samuels, 2004). They also suffer psychosocial problems, including low self-esteem, poor body image, and symptoms of depression (Samuels, 2004). This is highlighted by Recommended indicators (21.1, 21.5, 21.6).

Climate change means that floods are also increasing in frequency and intensity, and the frequency and intensity of extreme precipitation is expected to continue to increase throughout the current century (IPCC, 2014). A decrease in experienced nature is one aspect of urbanisation that has drawn researchers' attention with the purpose of developing methodologies to explore the affective and cognitive benefits of nature experience, and demonstrate the psychological benefits of our exposure to/engagement with nature (Bratman et al., 2015). The mental health benefits of urban green space have been highlighted by a growing body of knowledge and empirical evidence attesting to the complex interplay among stress responses, neighbourhood conditions, and health outcomes (Beyer et al., 2014; Frumkin et al., 2017; Hartig et al., 2014). More greenery in the neighbourhood was linked to lower levels of depression, anxiety, and stress (Beyer et al., 2014; Pope et al., 2015). Moreover, mental restoration and relaxation from leisure activities (e.g., walks in parks vs. walks in urban settings, gardening) pursued in the nature and green space have been studied as strong evidence of mental health benefits consequent to nature experience (Aspinall et al., 2013; Bratman et al., 2015; Braubach et al., 2017;; Hartig et al., 2014; van der Berg and Custers, 2011). These aspects are addressed in Recommended indicators 21.2–21.4, and 21.6.

⁴⁸ Climate change, justice and vulnerability. <http://bit.ly/16STKqy>

⁴⁹ <http://www.who.int/news-room/fact-sheets/detail/climate-change-and-health>

Numerous authors emphasize that modern urban wellbeing challenged by chronic stress (indicator 21.2) and insufficient physical activity can be healthily nurtured by natural environment exposure, which promotes mental and physical health and reduces morbidity and mortality in urban residents by providing psychological relaxation (indicators 21.3, 21.4) and stress alleviation, enhancing immune function, stimulating social cohesion, supporting physical activity (indicator 21.1), and reducing exposure to air pollutants, noise and excessive heat (Braubach et al., 2017; Hartig et al., 2014).

These health and wellbeing benefits are important not just at the individual level, but if implemented widely they could save expenditure on health care. Increasing the extent and improving the quality of green spaces in areas of cities where health outcomes are poor could also play an important role in addressing multiple deprivations.

Research on complex/multi-dimensional relationship between nature connectedness/nature affiliation (i.e., affective, cognitive and experiential factors related to our belonging to the natural world) and wellbeing indicate that exposure to elements of the natural world affects our well-being by boosting our positive affect, by eliciting feelings of ecstasy, respect, and wonder, by fostering feelings of comfort and friendliness, by heightening our intrinsic aspirations and generosity, and by increasing our vitality (Capaldi et al., 2014; Howell and Passmore, 2013), highlighted in Recommended indicators 21.3 and 21.4, and Additional indicators 22.11, 22.13, and 22.15.

The Additional indicators of NBS impacts on Health and Wellbeing focus on evaluating health and wellbeing aspects in relation to noise, heat and air pollution, and exploring psychological and chronic stress changes, including anxiety, in greater depth.

Table 4-11. Indicators related to Health and Wellbeing classified as structural (S), process focused (P) or outcome-based (O) indicators and their general applicability to different types of NBS

No.	Indicator	Units	Class	Applicability to NBS [†]		
				Type 1	Type 2	Type 3
RECOMMENDED						
21.1	Level of outdoor physical activity		O	●		●
21.2	Level of chronic stress (perceived stress)	Number (0-4)	O	●	●	●
21.3	General wellbeing and happiness	Number (0-7)	O	●	●	●

21.4	Self-reported mental health and wellbeing	Number (1-6)	0	●	●	●
21.5	Prevalence of cardiovascular disease	%	0	●		●
21.5	Incidence of cardiovascular disease	% per year	0	●		●
21.6	Quality of life	Number (1-5)	0	●	●	●

ADDITIONAL

22.1	Self-reported physical activity	Minutes per week	0	●		●
22.2	Observed physical activity within NBS	% over three levels of physical activity (sedentary, walking, or vigorous)	0	●		●
22.3	Encouraging a healthy lifestyle	Number (1-5)	0	●		●
21.5	Morbidity due to cardiovascular disease	No./y	0	●		●
21.5	Mortality due to cardiovascular disease	No./y	0	●		●
22.4	Incidence of obesity	% per year	0	●		●
22.5	Heat-related discomfort: Universal Thermal Climate Index (UTCI)	°C	0	●		●
22.6	Hospital admissions due to high temperature during extreme heat events	No. per 100 000	0	●		●
22.7	Heat-related mortality	No. per 1 000 000 per year	0	●		●
22.8	Exposure to noise pollution	%	0	●		●

22.9	Perceived chronic loneliness	Number (1-3) across 3 categories	0	●	●	●
22.10	Somatisation	Low, Moderately high, Very high	0	●	●	●
22.11	Mindfulness	Number (0-4) across 12 categories	0	●	●	●
22.12	Visual access to green space	Number (0-4)	0	●		●
22.12	Time spent viewing green space from residence each day	Number (0-3)	0	●		●
22.13	Perceived restorativeness of public green space/ NBS	Number (0-10) across 4 categories	0	●	●	●
22.14	Perceived social support	Number (0-4)	0	●	●	●
22.15	Connectedness to nature	Number (1-5) across 14 categories	0	●	●	●
22.16	Prevalence of attention deficit hyperactivity disorder (ADHD)	%	0	●		●
22.17	Exploratory behaviour in children		0	●		●
22.18	Self-reported anxiety	Mild, Moderate, Severe	0	●	●	●
22.19	Prevalence of respiratory diseases	%	0	●	●	●
22.19	Incidence of respiratory diseases	% per year	0	●	●	●
22.19	Morbidity of respiratory diseases	No./y	0	●	●	●
22.19	Mortality of respiratory diseases	No./y	0	●	●	●

22.20	Morbidity due to poor air quality	No./y	0	●	●	●
22.20	Mortality due to poor air quality	No./y	0	●	●	●
22.20	Years of life lost (YoLL) due to poor air quality	No. of years	0	●	●	●
22.21	Prevalence of autoimmune diseases	%	0	●	●	●
22.21	Incidence of autoimmune diseases	% per year	0	●	●	●
22.22	Prevalence of chronic stress	%	0	●	●	●
22.22	Incidence of chronic stress	% per year	0	●	●	●
22.22	Morbidity due to chronic stress	No./y	0	●	●	●

† **Type 1 NBS** – minimal or no intervention in ecosystems, with objectives related to maintaining or improving delivery of ecosystem services within and beyond the protected ecosystems

Type 2 NBS – extensive or intensive management approaches seeking to develop sustainable, multifunctional ecosystems and landscapes in order to improve delivery of ecosystem services relative to conventional interventions

Type 3 NBS – characterised by highly intensive ecosystem management or creation of new ecosystems

4.2.12 New Economic Opportunities and Green Jobs

The economic opportunities that are created by the adoption and implementation of NBS as a consequence of their social attractiveness and restorative value can be evaluated using the Recommended indicators 23.2, 23.4–23.6. Indicator 23.2 and related sub-indicators 23.2.1-23.2.3 provide several different metrics to evaluate changes in mean land or property value attributable to the implementation of local NBS. Indicator 23.4 specifically evaluates the use of ground floor building space for retail, commercial or public purposes in the proximity of NBS, whilst indicator 23.5 examines the gross value added (GVA) to the local economy each year in the area near implemented NBS. The value of recreational activities occurring in NBS is addressed by indicator 23.6.

Indicators of new economic opportunities are supported by assessment of the value of new jobs created per annum (23.3) as a result of new business opportunities and new jobs in the green sector. Green jobs are those that contribute environmental benefit. The International Labour Organization (ILO) defines green jobs within three categories: primary green activities (i.e., organic agriculture, sustainable forestry), secondary activities (i.e., renewable energy, clean industry, sustainable

construction) and tertiary activities (i.e., recycling, sustainable tourism, and sustainable transport).

There has been a great deal of research on the valuation of the benefits provided by the natural environment using a wide range of techniques. Indicators supporting the valuation of urban nature (23.1.1 and 23.1.2) and its ecosystem services enable quantification of NBS benefits translated into monetary terms. Economic valuation of NBS benefits provides a much-needed means to inform decision-making.

Additional indicators within the New Economic Opportunities and Green Jobs challenge area examine indirect economic activity in the area surrounding NBS, elements of NBS cost-benefit analysis (including the value of hydro-meteorological risk reduction), social return on investment, the value of NBS-based tourism, and the impact of local innovation, among others. The indicators identified for the New Economic Opportunities and Green Jobs challenge area address a relatively broad range of actions and potential or realised economic consequences.

Table 4-12. Indicators related to New Economic Opportunities and Green Jobs classified as structural (S), process focused (P) or outcome-based (O) indicators and their general applicability to different types of NBS

No.	Indicator	Units	Class	Applicability to NBS [†]		
				Type 1	Type 2	Type 3
RECOMMENDED						
23.1.1	Valuation of NBS: Value of NBS calculated using GI-Val	€	O	●	●	●
23.1.2	Economic value of urban nature	€	O	●	●	●
23.2	Mean land and/ or property value in proximity to green space	€	O	●		●
23.2.1	Change in mean house prices/ rental markets	€	O	●		●
23.2.2	Average land productivity and profitability	€/ha	O	●	●	●
23.2.3	Property betterment and visual amenity enhancement	€/m ²	O	●		●

23.3	Direct economic activity: Number of new jobs created	€/year	0	●	●	●
23.4	Direct economic activity: Retail and commercial activity in proximity to green space	%	0	●		●
23.5	Direct economic activity: Gross value added to local economy from new business creation	€/year	0	●	●	●
23.6	Recreational monetary value	€/year	0	●		●
23.7	Overall economic, social and health well-being	Human Development Index	0	●	●	●
ADDITIONAL						
24.1	Indirect economic activity: number of new businesses established in proximity to NBS	No./year	0	●		●
24.2	Indirect economic activity: Value of rates paid by businesses in proximity to NBS	€/year	0	●		●
24.3	Indirect economic activity: New customers to businesses in proximity to NBS	Mean No./day per quarter	0	●		●
24.4	Indirect economic activity: local economy GDP in proximity to NBS	€/year	0	●		●
24.5	NBS cost/benefit analysis: Initial costs	€	0	●	●	●
24.6	NBS cost/benefit analysis: Maintenance costs	€/year	0	●	●	●
24.7	NBS cost/benefit analysis: Replacement costs	€	0	●	●	●

24.8	NBS cost/benefit analysis: Avoided costs	€	O	●	●	●
24.9	NBS cost/benefit analysis: Payback period	year	O	●	●	●
24.10	Reduced/ avoided damage costs from hydro meteorological risk reduction	€/year	O	●	●	●
24.11	Social return on investment (SROI)	€/€	O	●	●	●
24.12	Income generated via application of green administrative policies within Living Lab district	€/year	O	●	●	●
24.13	Subsidies applied for private NBS measures	€/year	O	●	●	●
24.14	Private finance attracted to the NBS site/ private investment in the bioeconomy	€/year	O	●	●	●
24.15	Increase in tourism	Mean no. visitors/day per year	O	●		●
24.16	New activities in the tourism sector	Number (1-5)	O	●		●
24.17	Gross profit from nature-based tourism	€/year per km ²	O	●		●
24.18	Number of new jobs in green sector	%	O	●	●	●
24.19	Number of new jobs related to NBS construction and maintenance	Number (1-5)	O	●	●	●
24.20	New employment in the tourism sector	Number (1-5)	O	●		●
24.21	Turnover in the green sector	%	O	●	●	●
24.22	Employment in agriculture	No./ha	O	●	●	●

24.23	Rural Productivity Index	€/ha	O	●	●	●
24.24	Economic value of the productive activities vulnerable to risks	€/km ²	O	●	●	●
24.25	Innovation impact	No. innovations	O	●	●	●
24.26	Income per capita	€/year per person	O	●	●	●
24.26 24.26.1	Disposable income per capita	€/year per person	O	●	●	●
24.27	Upskilling and related earnings increase	Increase in employment earnings per person per year	O	●	●	●
24.28	Population mobility	% in 1 y % in 2 y % in 5 y	O	●		●
24.29	Avoided cost of run-off treatment	€/y	O	●	●	●
24.30	Correction cost of groundwater quality	€/m ³	O	●	●	●
24.31	Dissuasive cost of water abstraction	€/m ³	O	●	●	●
24.32	Average water productivity	€/m ³	O	●	●	●
24.33	New areas made available for traditional productive uses	km ²	O	●	●	●
24.34	Value of food produced in NBS	€/y	O		●	●
24.35	Renewable energy produced in NBS	kWh/y	O			●

† **Type 1 NBS** – minimal or no intervention in ecosystems, with objectives related to maintaining or improving delivery of ecosystem services within and beyond the protected ecosystems

Type 2 NBS – extensive or intensive management approaches seeking to develop sustainable, multifunctional ecosystems and landscapes in order to improve delivery of ecosystem services relative to conventional interventions

Type 3 NBS – characterised by highly intensive ecosystem management or creation of new ecosystems

4.3 Conclusions

4.3.1 *Summary of the indicator framework presented*

The Recommended indicators, taken together, are designed to provide a holistic assessment of the multiple potential co-benefits of NBS. Practitioners are encouraged to adopt as many of these Recommended indicators as practicable. Depending upon the specific context, some Recommended indicators may not be entirely applicable or may require adaptation to the local conditions or to overcome resource (personnel, equipment, finance) limitations. In such cases, the Additional indicators presented herein may serve as support, providing opportunity for monitoring and evaluation framework adaptation and tailoring to local conditions as necessary.

Critical thinking is required to select the indicators that suit the purpose and the scope of the NBS assessment strategy. Detailed information regarding the applicability and requirements for each indicator analysis are presented in the Appendix.

4.3.2 *Emerging concerns and further development needs*

There were a number of indicators initially discussed by the members of the H2020 NBS projects involved in producing this handbook that were ultimately not included herein due to a lack of consensus regarding assessment methodology. In many cases, further work is required to validate evaluation methods for a variety of the NBS forms and functions in order to establish a standardised procedure for assessment of NBS impact. Outcomes of on-going and future NBS projects are expected to deliver novel indicators of NBS impact across all societal challenge areas identified here.

Greater confidence in techniques for evaluation are needed, particularly for carbon flux measurements from natural ecosystems and heterogeneous urban areas. Reduction in price of monitoring equipment with technological advances should make monitoring more accessible and applicable.

Concerning the water management challenge, one of the main concerns is the identification and development of synergic strategies to safeguard and properly support ecosystem services. The effective detection of spatial and temporal scales allows assessing and fostering the ecosystem resilience and sustainability. Attention should be paid to investigating alternations to flow regime to account for the uncertainty and non-stationarity of the hydrologic methodologies. Technological advancement will make monitoring more accessible and applicable, particularly in relation to automated sampling and analysis, and in-pipe measurements of low flowrates. Advances in the accessibility of high-resolution imagery will yield more monitoring options.

For biodiversity assessment, greater standardisation of approaches is needed, this may come through increased requirement for reporting through legislative

and planning processes. There is also a need for indicators that capture the complexity and diversity of biodiversity evaluation beyond the usual suspects.

Additionally, a wide variety of indicators and methodologies are presented in this manual, not all of which have been validated to assess large-scale NBS interventions. In this sense, the results obtained in the current H2020 projects will serve to guide future projects and implementations in the selection of the most appropriate in each case. Likewise, it is necessary to consider the impacts of the COVID-19 pandemic on some of the assessment methodologies presented in this handbook and Appendix of Methods as some KPIs may require modifications to the way they are evaluated (e.g., changes to how use of green spaces is assessed due to local restrictions on movement). In some cases, the units of the KPIs may be modified to better apply to a specific case study or to improve the understanding of results.

4.4 References

- Aspinall, P., Mavros, P., Coyne, R., and Roe, J., 'The urban brain: Analyzing outdoor physical activity with mobile EEG', *British Journal of Sports Medicine*, Vol. 49, No 4, 2013, pp. 272-276.
- Benedict, M.A. and McMahon, E.T., '*Green infrastructure*', Island, Washington, D.C., 2006.
- Beyer, K.M., Kaltenbach, A., Szabo, A., Bogar, S., Nieto, F.J., and Malecki, K.M., 'Exposure to neighborhood green space and mental health: Evidence from the Survey of the Health of Wisconsin', *International Journal of Environmental Research and Public Health*, Vol. 11, No 3, 2014, pp. 3453-3472.
- Bhatnagar A., 'Environmental Determinants of Cardiovascular Disease', *Circulation Research*, Vol. 121, No 2, 2017, pp. 162-180.
- Brehm, B.J. and D'Alessio, D.A., 'Environmental factors influencing obesity', *Endotext*, MDText.com, Inc., South Dartmouth, 2014, pp. 2000. Retrieved from <https://www.ncbi.nlm.nih.gov/books/NBK278977/>
- Bratman, G.N., Hamilton, J.P., Hahn, K.S., Daily, G.C., and Gross, J.J., 'Nature experience reduces rumination and subgenual prefrontal cortex activation', *Proceedings of the National Academy of Sciences of the United States of America*, Vol. 112, No 28, 2015, pp. 8567-8572.
- Braubach, M., Egorov, A., Mudu, P., Wolf, T., Ward Thompson, C., and Martuzzi, M., 'Effects of Urban Green Space on Environmental Health, Equity and Resilience', *Nature-Based Solutions to Climate Change Adaptation in Urban Areas: Linkages between Science, Policy and Practice*, SpringerOpen, Cham, 2017, pp. 187-205.
- Calliari, E., Staccione, A., and Mysiak, J., 'An assessment framework for climate-proof nature-based solutions', *Science of the Total Environment*, Vol. 656, 2019, pp. 691-700.
- Capaldi, C.A., Dopko, R.L., and Zelenski, J.M., 'The relationship between nature connectedness and happiness: a meta-analysis', *Frontiers in Psychology*, Vol. 5, 2014, pp. 976.
- Cloete, A., 'Social cohesion and social capital: Possible implications for the common good', *Verbum et Ecclesia*, Vol. 35, No 3, 2014, Art. no 1331, 6 pp.
- Cohen-Shacham, E., Walters, G., Janzen, C., and Maginnis, S. (Eds.), *Nature-based Solutions to address global societal challenges*, International Union for the Conservation of Nature, Gland, Switzerland, 2016.
- Davies, C. and Laforteza, R., 'Transitional path to the adoption of nature-based solutions', *Land Use Policy*, Vol. 80, 2019, pp. 406-409.
- Demuzere, M., Orru, K., Heidrich, O., Olazabal, E., Geneletti, D., Orru, H., and Faehnle, M., 'Mitigating and adapting to climate change: Multi-functional and multi-scale assessment of green urban infrastructure', *Journal of Environmental Management*, Vol. 146, 2014, pp. 107-115.
- Derr, V., 'Urban green spaces as participatory learning laboratories', *Proceedings of the Institution of Civil Engineers-Urban Design and Planning*, Vol. 171, No 1, 2017, pp. 25-33.

- Donabedian, A., 'Evaluating the quality of medical care', *The Millbank Memorial Fund Quarterly*, Vol. 44, 1966, pp. 166-203.
- Eggermont, H., Balian, E., Azevedo, J.M.N., Beumer, V., Brodin, T., Claudet, J., Fady, B., Grube, M., Keune, H., Lamarque, P., Reuter, K., Smith, M., van Ham, C., Weisser, W.W., and Le Roux, X., 'Nature-based solutions: New influence for environmental management and research in Europe', *GAIA*, Vol. 24, No 4, 2015, pp. 243-248.
- Ernst, L., de Graaf-Van Dinther, R.E., Peek, G.J., and Loorbach, D.A., 'Sustainable urban transformation and sustainability transitions; conceptual framework and case study', *Journal of Cleaner Production*, Vol. 112, 2016, pp. 2988-2999.
- European Commission, *Green Infrastructure (GI) — Enhancing Europe's Natural Capital*, COM(2013) 249 final, 2013.
- European Commission, *Towards an EU Research and Innovation policy agenda for Nature-Based Solutions & Re-Naturing Cities. Final Report of the Horizon 2020 Expert Group on 'Nature-Based Solutions and Re-Naturing Cities'*, Publications Office of the European Union, Luxembourg, 2015.
- European Commission, *Commission Staff Working Document: Guidance on a strategic framework for further supporting the deployment of EU-level green and blue infrastructure*, SWD(2019) 193 final, 2019a.
- European Commission, *Report from the Commission to the European Parliament, the Council, the European Economic and Social Committee and the Committee of the Regions: Review of progress on implementation of the EU green infrastructure strategy*, COM(2019) 236 final, 2019b.
- European Commission, *EU Biodiversity Strategy for 2030: Bringing Nature Back into Our Lives*, COM(2020) 380 Final, 2020.
- Feldman, R.M. and Westphal, L.M., 'An agenda for community design and planning: Participation and empowerment practice', *Sustaining human settlement: a challenge for the new millennium*, Urban International Press, North Shields, Great Britain, 1999, pp. 105-139.
- Frantzeskaki, N., 'Seven lessons for planning nature-based solutions in cities', *Environmental Science and Policy*, Vol. 93, 2019, pp. 101-111.
- Frantzeskaki, N. and Kabisch, N., 'Designing a knowledge co-production operating space for urban environmental governance—Lessons from Rotterdam, Netherlands and Berlin, Germany', *Environmental Science and Policy*, Vol. 62, 2016, pp. 90-98.
- Frumkin, H., Bratman, G.N., Breslow, S.J., Cochran, B., Kahn, P.H., Jr., Lawler, J.J., Levin, P.S., Tandon, P.S., Varanasi, U., Wolf, K.L., and Wood, S.A., 'Nature Contact and Human Health: A Research Agenda', *Environmental Health Perspectives*, Vol. 125, No 7, 2017, pp. 075001.
- Gentin, S., Pitkänen, K., Chondromatidou, A.M., Præsthholm, S., Dolling, A., and Palsdottir, A.M., 'Nature-based integration of immigrants in Europe: A review', *Urban Forestry and Urban Greening*, Vol. 43, 2019, pp. 1-8.
- Grimm, N.B., Faeth, S.H., Golubiewski, E.N., Redman, C.L., Wu, J., Bai, X., and Briggs, J.M., 'Global change and the ecology of cities', *Science*, Vol. 319, 2008, pp. 756-760.
- Haase, D., Larondelle, N., Andersson, E., Artmann, M., Borgström, S., Breuste, J., Gomez-Baggethun, E., Gren, Å., Hamstead, Z., Hanson, R., Kabisch, N., Kremer, P., Langemeyer, J., Lorance Rall, E., McPhearson, T., Pauleit, S., Qureshi, S., Schwartz, N., Voigt, A., Wurster, S., and Elmqvist, T., 'A Quantitative Review of Urban Ecosystem Service Assessments: Concepts, Models, and Implementation', *AMBIO*, Vol. 43, No 4, 2014, pp. 413-433.
- Handy, S.L. and Niemeier, D.A., 'Measuring accessibility: an exploration of issues and alternatives', *Environment and Planning A*, Vol. 29, No 7, 1997, pp. 1175-1194.
- Hartig, T., Mitchell, R., de Vries, S., and Frumkin, H., 'Nature and Health', *Annual Review of Public Health*, Vol. 35, 2014, pp. 207-228.
- Hedefalk, M., Almqvist, J., and Östman, L., 'Education for sustainable development in early childhood education: a review of the research literature', *Environmental Education Research*, Vol. 21, No 7, 2015, pp. 975-990.
- Howell, A.J. and Passmore, H.-A., 'The nature of happiness: Nature affiliation and mental well-being', *Mental well-being: International contributions to the study of positive mental health*, Springer, New York, 2013, pp. 231-257.
- Ibes, D.C., 'A multi-dimensional classification and equity analysis of an urban park system: A novel methodology and case study application', *Landscape and Urban Planning*, Vol 137, 2015, pp. 122-137.

- IPCC, 'Summary for Policymakers', *Climate Change 2014: Mitigation of CC. Contribution of Working Group III to the 5th Assessment Report of the IPCC*, New York, Cambridge University Press, 2014.
- Jahn, T., Bergmann, M., and Keil, F., 'Transdisciplinarity: Between mainstreaming and marginalization', *Ecological Economics*, Vol. 79, 2012, pp.1-10.
- Kabisch, N., Korn, H., Stadler, J., and Bonn, A. (Eds.), 'Nature-Based Solutions to Climate Change Adaptation in Urban Areas', *Theory and Practice of Urban Sustainability Transitions*, Springer, Cham, 2017.
- Korkmaz, C. and Balaban, O., 'Sustainability of urban regeneration in Turkey: Assessing the performance of the North Ankara Urban Regeneration Project', *Habitat International*, Vol. 95, 2020, pp. 1-14.
- Kudryavtsev, A., Krasny, M.E., and Stedman, R.C., 'The impact of environmental education on sense of place among urban youth', *Ecosphere*, Vol. 3, No 4, 2012, pp. 1-15.
- Kweon, B.S., Sullivan, W.C., and Wiley, A.R., 'Green common spaces and the social integration of inner-city older adults', *Environment and Behavior*, Vol. 30, No 6, 1998, pp. 832-858.
- Maes, J., Zulian, G., Günther, S., Thijssen, M., and Raynal, J., *Enhancing Resilience of Urban Ecosystems through Green Infrastructure. Final Report, EUR 29630 EN*, Luxembourg, Publications Office of the European Union, 2019.
- Maes, J., Zulian, G., Thijssen, M., Castell, C., Baró, F., Ferreira, A.M., Melo, J., Garrett, C.P., David, N., Alzetta, C., Geneletti, D., Cortinovis, C., Zwierchowska, I., Louro Alves, F., Souto Cruz, C., Blasi, C., Alós Ortí, M.M., Attorre, F., Azzella, M.M., Capotorti, G., Copiz, R., Fusaro, L., Manes, F., Marando, F., Marchetti, M., Mollo, B., Salvatori, E., Zavattero, L., Zingari, P.C., Giarratano, M.C., Bianchi, E., Duprè, E., Barton, D., Stange, E., Perez-Sob, M., van Eupen, M., Verweij, P., de Vries, A., Kruse, H., Polce, C., Cugny-Seguín, M., Erhard, M., Nicolau, R., Fonseca, A., Fritz, M., and Teller, A., *Mapping and Assessment of Ecosystems and their Services, Urban Ecosystems*, Publications Office of the European Union, Luxembourg, 2016.
- Maes, J., Teller, A., Erhard, M., Conde, S., Vallecillo Rodriguez, S., Barredo Cano, J.I., Paracchini, M., Abdul Malak, D., Trombetti, M., Vigiak, O., Zulian, G., Addamo, A., Grizzetti, B., Somma, F., Hagyo, A., Vogt, P., Polce, C., Jones, A., Marin, A., Ivits, E., Mauri, A., Rega, C., Czucz, B., Ceccherini, G., Pisoni, E., Ceglar, A., De Palma, P., Cerrani, I., Meroni, M., Caudullo, G., Lugato, E., Vogt, J., Spinoni, J., Cammalleri, C., Bastrup-Birk, A., San-Miguel-Ayanz, J., San Román, S., Kristensen, P., Christiansen, T., Zal, N., De Roo, A., De Jesus Cardoso, A., Pistocchi, A., Del Barrio Alvarellós, I., Tsiamis, K., Gervasini, E., Deriu, I., La Notte, A., Abad Viñas, R., Vizzarri, M., Camia, A., Robert, N., Kakoulaki, G., Garcia Bendito, E., Panagos, P., Ballabio, C., Scarpa, S., Montanarella, L., Orgiazzi, A., Fernandez Ugalde, O., and Santos-Martín, F., *Mapping and Assessment of Ecosystems and their Services: An EU ecosystem assessment, EUR 30161 EN*, Publications Office of the European Union, Luxembourg, 2020.
- McCormick, K., Anderberg, S., Coenen, L., and Neij, L., 'Advancing sustainable urban transformation', *Journal of Cleaner Production*, Vol. 50, 2013, pp. 1-11.
- Páez, A., Scott, D.M., and Morency, C., 'Measuring accessibility: positive and normative implementations of various accessibility indicators', *Journal of Transport Geography*, Vol. 25, 2012, pp. 141-153.
- Pauleit, S., Zölch, T., Hansen, R., Randrup, T.B., and van den Bosch, C.K., 'Nature-based solutions and climate change—four shades of green', *Nature-Based Solutions to Climate Change Adaptation in Urban Areas*, Springer, Cham, 2017, pp. 29-49.
- Pope, D., Tisdall, R., Middleton, J., Verma, A., Van Ameijden, E., Birt, C., and Bruce, N.G., 'Quality of and access to green space in relation to psychological distress: results from a population-based cross-sectional study as part of the EURO-URHIS 2 project', *European Journal of Public Health*, Vol. 28, No 1, 2015, pp. 35-38.
- Querol, X., Karanasiou, A., Amato, F., Vasconcelos, C., Alastuey, A., Viana, M., Moreno, T., Plana, F., Perez, N., Cabañas, M., Bartoli, R., Martinez, S., Sosa, M., Montfort, E., Celades, I., Escrig, A., Sanfelix, V., Gomar, S., Harrison, R., Holman, C., Beddows, D., Harding, M., Eleftheriadis, K., Diapouli, L., Vratoulis, S., Gini, M., Bairaktari, E., Dalaina, S., Galifianakis, V., Lucarelli, F., Nava, S., Calzolari, G., Udristi, R., Becagli, S., Traversi, R., Severi, M., Borselli, S., Giannoni, M., Alves, C., Pio, C., Nunes, T., Tarelho, L., Duarte, M., Cerqueira, M., Vicente, E., Custódio, D., Pinto, H., Gianelle, V.L., and Colombi, C., 'Air Quality and Climate Change Abatement: Synergies and Conflicts, Report 23, 12/2016', LIFE AIRUSE (LIFE11 ENV/ES/584), 2016.
- Raymond, C.M., Frantzeskaki, N., Kabisch, N., Berry, P., Breil, M., Nita, M.R., Geneletti, D., and Calfapietra, C., 'A framework for assessing and implementing the co-benefits of nature-based solutions in urban areas', *Environmental Science and Policy*, Vol. 77, 2017, pp. 15-24.
- Raymond, C.M., Gottwald, S., Kuoppa, J., and Kyttä, M., 'Integrating multiple elements of environmental justice into urban blue space planning using public participation geographic information systems', *Landscape and Urban Planning*, Vol. 153, 2016, pp. 198-208.

- Roberts, P. and Sykes, H. (Eds.), *Urban regeneration: a handbook*, London, SAGE Publications Ltd, 2000.
- Robine, J.-M., Cheung, S.L.K., Le Roy, S., Van Oyen, H., Griffiths, C., Michel, J.-P., and Herrmann, F.R., 'Death toll exceeded 70,000 in Europe during the summer of 2003 / Plus de 70 000 décès en Europe au cours de l'été 2003', *Comptes Rendes Biologies*, Vol. 331, No 2, 2008, pp. 171-178.
- Samuels, S.E., *Environmental strategies for preventing childhood obesity, Acceleration Meeting Memo, January 8 and 9, 2004*, Berkeley Media Studies Group, Berkeley, 2004.
- Shanahan, D.F., Fuller, R.A., Bush, R., Lin, B.B., and Gaston, K.J., 'The Health Benefits of Urban Nature: How Much Do We Need?', *BioScience*, Vol. 65, 2015, pp. 476-485.
- Shanahan, D.F., Bush, R., Gaston, K.J., Lin, B.B., Dean, J., Barber, E., Fuller, R.A., 'Health Benefits from Nature Experiences Depend on Dose', *Scientific Reports*, Vol. 6, Art. no 28551, 2016.
- Sinnett, D., Smith, N., and Burgess, S. (Eds.), *Handbook on Green Infrastructure: Planning, design and implementation*, Edward Elgar Publishing Ltd, Cheltenham, 2015.
- Somarakis, G., Stavros, S., Chrysoulakis, N. (Eds.), *ThinkNature Nature-Based Solutions Handbook*, ThinkNature project funded by the EU Horizon 2020 research and innovation programme under grant agreement No 730338, 2019, doi:10.26225/ jerv-w202.
- Tzoulas, K., Korpela, K., Venn, S., Yli-Pelkonen, V., Kaźmierczak, A., Niemela, J., and James, P., 'Promoting ecosystem and human health in urban areas using Green Infrastructure: A literature review', *Landscape and urban planning*, Vol. 81, No 3, 2007, pp. 167-178.
- Uzzell, D., Pol, E., and Badenas, D., 'Place identification, social cohesion, and environmental sustainability', *Environment and Behavior*, Vol. 34, No 1, 2002, pp. 26-53.
- van den Berg, M.M., van Poppel, M., van Kamp, I., Ruijsbroek, A., Triguero-Mas, M., Gidlow, C., Nieuwenhuijsen, M.J., Gražulevičiene, R., van Mechelen, W., Kruize, H., and Maas, J., 'Do physical activity, social cohesion, and loneliness mediate the association between time spent visiting green space and mental health?', *Environment and Behavior*, Vol. 51, No 2, 2017, pp. 144-166.
- Van Den Berg, A.E. and Custers, M.H.G., 'Gardening Promotes Neuroendocrine and Affective Restoration from Stress', *Journal of Health Psychology*, Vol. 16, No 1, 2011, pp. 3-11.
- Varela-Candamio, L., Novo-Corti, I., and García-Álvarez, M.T., 'The importance of environmental education in the determinants of green behavior: A meta-analysis approach', *Journal of Cleaner Production*, Vol. 170, 2018, pp. 1565-1578.
- Vujcic, M., Tomicevic-Dubljevic, J., Grbic, M., Lecic-Tosevski, D., Vukovic, O., and Toskovic, O., 'Nature-based solution for improving mental health and well-being in urban areas', *Environmental Research*, Vol. 158, 2017, pp. 385-392.
- Wendling, L.A., Huovila, A., zu Castell-Rüdenhausen, M., Hukkalainen, and M., Airaksinen, M., 'Benchmarking nature-based solution and Smart City assessment schemes against the Sustainable Development Goal indicator framework', *Frontiers in Environmental Science*, Vol. 6, Art. no 69, 2018, 18 pp.
- World Health Organisation, *Urban green spaces and health*, WHO Regional Office for Europe, Copenhagen, 2016.
- World Health Organisation, *Urban Green Space Interventions and Health: A review of impacts and effectiveness*, WHO Regional Office for Europe, Copenhagen, 2017.
- Xiang, P., Wang, Y., and Deng, Q., 'Inclusive nature-based solutions for urban regeneration in a natural disaster vulnerability context: A case study of Chongqing, China', *Sustainability*, Vol. 9, No 7, 2017, pp. 1-13.

Drawing on knowledge from projects funded by the European Union



CLEARING HOUSE

Collaborative LEArning in Research, Information-sharing and Governance on How Urban forests as nature-based solutions support Sino-European futures

Barcelona (ES)

Beijing (CN)

Brussels (BE)

Krakow (PL)

Leipzig (DE)

Gelsenkirchen (DE)

Hangzhou (CN)

Hong Kong - Guangzhou - Shenzhen (CN)

Huaibei (CN)

Xiamen (CN)

CLEARING HOUSE addresses a global challenge that unites European and Chinese cities in their quest to develop more resilient cities and liveable societies. Our main focus is on tree-based green infrastructure which is the basis for "urban forests as nature-based solutions". Urban Forests as nature-based solutions (UF-NBS) are nature-based solutions that build on tree-based urban ecosystems to address societal challenges, simultaneously providing ecosystem services for human well-being and biodiversity benefits. UF-NBS include peri-urban and urban forests, forested parks, small woods in urban areas, and trees in public and private spaces. CLEARING HOUSE will analyse and develop the potential of UF-NBS- across China and Europe - in order to enhance the resilience of cities facing major ecological, socio-economic, and human wellbeing challenges.

SCOPE Trees are the solution - Implementing and managing tree-based ecosystems as nature-based solutions for sustainable urbanization

Approach to Impact Assessment

CLEARING HOUSE is focusing on the impact created by tree-based ecosystems in an urban and peri-urban context. CLEARING HOUSE is using innovative approaches and innovative tools to assess the impact of trees, woods and forests to the urban environment, based on a holistic and interdisciplinary analytical framework. CLEARING HOUSE is developing a citizen science UF-NBS monitoring tool, that citizens can use to map, assess and monitor UF-NBS and their socio-ecological impacts. A benchmarking tool will allow to compare UF-NBS in different settings, and will be used as a quick scan to assess UF-NBS designs. The scenario evaluator will allow to optimize UF-NBS planning, design and management at the local and regional level.

Involved Stakeholders and roles

The tools that CLEARING HOUSE is developing are aimed towards citizens, local and regional authorities, landscape architects, environmental planners, urban planners, architects, decision-makers, politicians and natural resource managers. But also experts from public health and social work will be able to use our tools, to support UF-NBS as a tool to combat social injustice and health inequality. Citizens and citizen groups will be able to use the citizen science tool, by mapping existing resources and having their impacts assessed by the tool. The scenario evaluator and benchmarking tools are more focused towards experts, decision-makers, and planners: planners and experts can design solutions and create diverging scenarios; decision-makers can make informed decisions based on the assessment of the diverging scenarios by the scenario evaluator and the benchmarking tool.

Municipal Administrations

Citizen

Planning experts

Scientists / Academia

NGOs

Landscape businesses

Schools and kindergartens

politicians

Natural resource managers

Main Challenges addressed

1. Climate Resilience

2. Water Management

3. Natural and Climate Hazards

4. Green Space Management

5. Biodiversity

6. Air Quality

7. Place Regeneration

8. Knowledge and Social Capacity Building

9. Participatory Planning and Governance

10. Social Justice and Social Cohesion

11. Health and Wellbeing

12. New Economic Opportunities & Green Jobs

Lessons learned

We have learned that people and trees have an intense relationship. This is helpful to find support and funding for designing, planting and managing trees, woods and forests in and around towns and cities. The COVID-19 pandemic – and its resulting restrictions – have showed that urban green spaces are very important to the public, and that they offer space for finding peace and to recover, places for recreation and physical activity, but also to meet other people in a socially distant way.

However, tree-based impacts are difficult to assess completely, as they provide a range of benefits – but also disbenefits. Disbenefits tend to be overlooked, which in the end can lead to tensions related to trees in the urban area.

Learn more
www.clearinghouseproject.eu



The CLEARING HOUSE project has received funding from the European Union's Horizon 2020 research and innovation programme under grant agreement No 821242.

Drawing on knowledge from projects funded by the European Union



REGREEN

Fostering nature-based solutions for equitable, green and healthy urban transitions in Europe and China

Aarhus (DK) Paris Region (FR) Velika Gorica (HR)
Beijing (CN) Ningbo (CN) Shanghai (CN)

REGREEN aims to substantially advance evidence and tools by systematically modelling ecosystem services and biodiversity, and examining synergies and trade-offs between them. This forms the basis for guiding city authorities in effective planning and implementation of urban NBS in Europe and China. This includes policy experimental learning, strategies for depavement, education and citizen science in schools, valuation of benefits and costs and the development of business models for realising spatially relevant NBS that provide multiple ecosystem services and wellbeing.

Approach to Impact Assessment

By creating new ecosystem service models which take into account local situations, the project will produce new tools and guidance which can be used in the planning stage of NBS design. A strength of the tools is to help city authorities find the optimum location for any intervention, which can satisfy multiple outcomes. The potential impact of new NBS can be assessed through scenarios, using the models to evaluate before and after situations at the planning stage. The metrics produced by the models allow assessment against physical metrics (amount of noise mitigated, pollution removed, biodiversity enhanced) and societal, health and economic metrics where appropriate (such as number of people experiencing reduced heat-stress, economic value of carbon sequestered). Metrics of success in the project include the number of new NBS projects where scientific outcomes from REGREEN have helped inform the design or location at the planning stage.

Involved Stakeholders and roles

In REGREEN, Urban Living Labs (ULLs) are formed by municipal administrations, a regional development agency and network of local and regional governments in Europe and China together with local universities and SMEs. Together, they work on uncovering, mapping and engaging a whole ecosystem of local stakeholders in order to advance the agenda of greening cities. For instance, ULL transition workshops in Europe and China will enable sharing of experience between ULLs and with local stakeholders; experimental policy learning in the ULLs among the public, stakeholders and city authorities aims to nurture innovative and novel governance approaches to NBS; and co-creation with children, schoolteachers, park managers and landscape architect students will enhance children's play and learning activities.

Municipal Administrations

Citizen

Planning experts

Scientists / Academia

NGOs

Green businesses

Schools and kindergartens

Main Challenges addressed

1. Climate Resilience

2. Water Management

3. Natural and Climate Hazards

4. Green Space Management

5. Biodiversity

6. Air Quality

7. Place Regeneration

8. Knowledge and Social Capacity Building

9. Participatory Planning and Governance

10. Social Justice and Social Cohesion

11. Health and Wellbeing

12. New Economic Opportunities & Green Jobs

Lessons learned

Although still at an early stage in the project, there is genuine interest from city authorities in how REGREEN can help design and optimize locations for new planned NBS initiatives. To this end, REGREEN co-creates with city authorities comprehensive scenarios of NBS interventions that form the basis for assessing the multiple impacts of NBS in ecosystem models. Impacts cover air pollution, urban heat islands, noise, flooding, water quality and biodiversity. Valuation of benefits to society and costs of implementation and maintenance will further help city authorities prioritise and plan NBS interventions.

Learn more
www.regreen-project.eu



05

Illustration of NBS impact indicator selection and application

Appendix of Methods

What constitutes NBS monitoring?

How do I develop a robust NBS monitoring plan?

How can I execute monitoring and impact assessment activities?

What indicators of NBS impact can I use?

How do I select appropriate indicators of NBS impact?

Why is it important to evaluate the impacts of NBS?

How can I ensure NBS work for Disaster Risk Reduction?

What kinds of NBS monitoring data can I gather, and how should I manage these data?

5 APPLICATION OF THE NBS IMPACT EVALUATION FRAMEWORK: NBS PERFORMANCE AND IMPACT EVALUATION CASE STUDIES

Coordinating Lead authors

Dubovik, M., Dumitru, A., Wendling, L.

Lead authors

Briega, P., Capobianco, V., Connop, S., Crespo, L., Feroso, J., Giannico, V., Gómez, S., González, M., Kakoulaki, G., Kumar, P., Leppänen, S., Marijuan, R., Pablo, S., Pérez, J.A., Pilla, F., Rinta-Hiiri, V., Riquelme, H., Sánchez, E., Sánchez, I., Sánchez, J.C., Sánchez, R., San José, E., Sanz, J.M., Sanz, N., Serramia, J., Spano, G., Särkilähti, M., Tomé-Lourido, D., van de Sijpe, K., Verdugo, F., Villazán, A., Vos, P., Zulian, G.

Contributing authors

Allaert, K., Almenar, J.B., Arnbjerg-Nielsen, K., Baldacchini, C., Basco, L., Beaujouan, V., Benoit, G., Bockarjova, M., Bonelli, S., Bouzouidja, R., Butlin, T., Calatrava, J., Calfapietra, C., Cannavo, P., Caroppi, G., Chancibault, K., Cioffi, M., Dadvand, P., de Bellis, Y., de Keijzer, C., de la Hera, A., Decker, S., Djordjevic, S., Dushkova, D., Faneca, M., Fatima, Z., Ferracini, C., Fleury, G., García, I., García-Alcaraz, M., Gerundo, C., Gil-Roldán, E., Giordano, R., Giugni, M., Gonzalez-Ollauri, A., Guidolotti, G., Haase, D., Heredida, J., Hermawan, T., Herranz-Pascual, K., Hölscher, K., Jermakka, J., Kiss, M., Kraus, F., Körmöndi, B., Laikari, A., Laille, P., Lemée, C., Llorente, M., Lodder, M., Lourido, D.T., Macsinga, I., Manzano, M., Martelli, F., Martins, R., Mayor, B., McKnight, U., Mendizabal, M., Mendonça, R., Mickovski, S.B., Nash, C., Nadim, F., Nolan, P., Oen, A., Olsson, P., Olver, C., Paradiso, F., Petucco, C., Pisani, N., Piton, G., Pugliese, F., Rasmussen, M., Munro, K., Reich, E., Reichborn-Kjennerud, K., Renaud, F., Rhodes, M.L., Robles, V., Rodriguez, F., Roebeling, P., Ruangpan, L., Rugani, B., Rödl, A., Sánchez Torres, A., Sanesi, G., Scharf, B., Silvestri, F., Skodra, J., Stanganelli, M., Szkordilis, F., Tacnet, J.-M., Vay, L., Vella, S., Vercelli, M., Vojinovic, Z., Werner, A., Wheeler, B., Young, C., Zorita, S., zu-Castell Rüdénhausen, M.

Summary

What is this chapter about?

Selecting appropriate indicators of NBS performance and impact can be challenging, and is context-dependent. In this chapter, we present case studies from a variety of NBS demonstrations across Europe and Asia that illustrate the application of the NBS indicators and methods presented in Chapter 4 and thoroughly described in *Evaluating the Impact of Nature-Based Solutions: Appendix of Methods*. Each case study presents a brief NBS description, reasons for the selection of specific indicators for that particular NBS and a brief overview of the ways the indicators are applied and/or monitored. The case studies describe the stakeholders involved in co-design and co-monitoring of NBS and discuss the barriers and lessons learned during or after the process. Each case study provides key references for further reading.

The case studies in this chapter focus on the selection of recommended indicators for NBS performance and impact, which are generally of primary importance when creating NBS monitoring and evaluation plans. The case studies further demonstrate how and why additional indicators can be selected to reflect particular objectives of projects and local challenges.

How can I use this chapter in my work with NBS?

The examples of indicator application illustrate the practice of selecting the appropriate indicators from the pool of indicators presented in Chapter 4. This information will aid in understanding *why* and *how* to select indicators for evaluating NBS performance and impact.

Information from the case studies presented in Chapter 5 can be used to support planning, indicator selection, execution and monitoring of NBS.

When should I use this knowledge in my work with NBS?

We recommend consulting the case studies during the early stages of NBS planning and deployment, and well before selecting indicators and establishing NBS monitoring.

How does this chapter link with the other parts of the handbook?

Chapter 5 complements the presentation of NBS indicators (Chapter 4 and Appendix of Methods) by presenting explicit examples tied to concrete NBS actions. This chapter assists in making a selection of the indicators listed under Chapter 4. It provides insights into NBS monitoring approaches described in Chapters 2, 3 and 6, and alludes to data generation techniques discussed in Chapter 7.

5.1 Introduction to holistic NBS impact assessment using the framework of recommended indicators

A series of concrete examples of the application of Recommended indicators are provided here to illustrate the type of narrative it is possible to develop from the gathered evidence. Specific messages regarding NBS outcomes can be tailored for different stakeholders, e.g., citizens, investors, policy-makers, etc. The Recommended indicators illustrated in the following examples reflect the multi-functionality of NBS and highlight synergies between outcomes in different societal challenge areas.

For the sake of demonstrating the importance of each individual indicator, the case studies presented herein describe only the basis for the selection of one, or in some cases several, either Recommended or Additional indicators (Chapter 4). This approach was adopted to highlight the importance of the Recommended indicators as the primary indicators to be addressed when creating NBS monitoring and evaluation plans, and to emphasise the value of selecting unique and complementing Additional indicators based on projects' objectives and the local challenges NBS aim to address. The case studies were selected per projects' suggestions given their relative advancement in NBS and their monitoring strategy implementation. It should be noted that although the case studies present indicators associated with a specific impact (e.g., water quality or air quality), the NBS exhibit a much greater number of impacts and co-benefits (e.g., on biodiversity, health and well-being), which must be considered when designing a monitoring strategy.

It is important to note that selected indicators of NBS impact should capture not only the range of different NBS co-benefits, but should also shed light on trade-offs for different social groups and between different challenge areas. For example, issues of gentrification, social justice and similar should be carefully considered in order to gain an understanding of both benefits and trade-offs, and to identify potential issues in order to develop effective mitigation strategies.

This Chapter is presented as a series of case studies related to the selection of [Recommended indicators](#) and [Additional indicators](#). Table 6-1 lists the Recommended and Additional indicators illustrated in the case studies.

Table 5-1. Case studies illustrating the selection of Recommended and Additional indicators.

Challenge	Recommended indicator case study	Additional indicator case study
Climate Resilience	Carbon storage	Urban Heat Island incidence
Water Management	Water quality: total suspended solids (TSS) content; Nitrogen and phosphorus concentration or load	-
Natural and Climate Hazards	-	Flood risk
Green Space Management	Green space accessibility	Walkability; Annual trend in vegetation cover; Nature-based recreation; Land composition
Biodiversity Enhancement	Green infrastructure connectivity	Number of conservation priority species
Air Quality	PM₁₀ and PM_{2.5} concentrations	Trends in NO_x and SO_x emissions
Knowledge and Social Capacity Building for Sustainable Urban Transformation	-	Connectedness to nature
Social Justice and Social Cohesion	-	Perceived social support
Health and Wellbeing	Level of outdoor physical activity (min/week); Level of chronic stress ("Perceived stress"); Self-reported general wellbeing	Prevalence, incidence, morbidity of chronic stress; Perceived chronic loneliness

5.1.1 Recommended indicators case study from Tampere, Finland

NBS Name and Location	Vuores stormwater management system (incl. retention pond, biofilter, alluvial meadows) Tampere (Finland)
<p>Brief description of NBS</p>	<p>The Vuores district is a new district in the City of Tampere (Finland), featuring an extensive stormwater management system (in Virolainen- and Tervaslampi Parks) comprising of several NBS, including the retention pond, biofilter, and alluvial meadows. The Vuores catchment drains to the Lake Koipijärvi, so preservation of the lake water quality was the main driver for creating a comprehensive urban runoff management (quality and quantity) system.</p> <p>Virolainen Park:</p> <ul style="list-style-type: none"> - Biofilter (with sand as a filtering media): Treatment of urban runoff and runoff from a dog park <p>Tervaslampi Park:</p> <ul style="list-style-type: none"> - Retention pond: Treatment (retention and sedimentation) of urban runoff from new housing area - Alluvial meadows: Space for retention of the urban runoff at times of heavy rainfall <p>Useful links: https://unalab.eu/en/our-cities/city-tampere www.tampere.fi/unalab (in Finnish)</p>
<p>Indicators of relevance</p>	<p>3.2 Water quality: total suspended solids (TSS) content 3.3 Nitrogen and phosphorus concentration or load</p>
<p>Explanation for selection of Indicators in this case</p>	<p>Due to the densification and urbanisation of the newly built areas, stormwater quality management was the main priority for the City of Tampere to prevent the water quality deterioration of the local waterbodies. TSS content and nutrient (N and P) concentrations comprise the critical water quality constituents determining the urban runoff quality entering the surface waterbodies and their possible adverse effects on the aquatic environment (e.g., eutrophication). The NBS addressing water quality further aid in delivering a variety of co-benefits, including water quantity management, enhancement of local biodiversity, and contributing to increased local environmental awareness.</p>
<p>Description of Indicator Application</p>	<p>Multiple NBS across the Vuores district are equipped with the online water quality sensors continuously measuring a variety of water quality parameters. Each sensor is capable of measuring the basic water quality parameters, including nitrate-nitrogen (NO₃-N) concentrations. Subsequently, the sensors calculate total phosphorus concentration based on the turbidity measurements, and total nitrogen concentration based on the nitrate-nitrogen measurements. Manual sampling for TSS content is performed at regular time intervals.</p>

Stakeholders involved	City representatives, citizens, NGOs, public and private sector actors (incl. research organisations), and representatives from universities
Barriers encountered and lessons learned	<p>Barriers to 'physical' NBS implementation in Tampere included the biofilter space requirements in Virolainen Park. Some residents found the alluvial meadows and wetland vegetation (Figure 5-1) lacking the aesthetics. However, this was overcome through awareness raising with the information signs and during the co-creation workshops.</p> <p>The stakeholder engagement proved to be successful after a series of co-creation workshops that resulted in the change of plans for the Vuores area development, additionally considering local biodiversity, health and water management aspects (Särkilahti 2019).</p>
Case study authors	<p>Maria Dubovik¹ (maria.dubovik@vtt.fi), Ville Rinta-Hiiri¹, Maarit Särkilahti², Salla Leppänen²</p> <p>¹VTT Technical Research Centre of Finland, Espoo, Finland ²City of Tampere, Finland</p>
References	<p>Särkilahti, M., 'Co-creating nature based solutions in EU project demonstration city Tampere', <i>Rakennustekniikka</i>, 2019. Available from: https://www.ril.fi/fi/rakennustekniikka/teemat/co-creating-nature-based-solutions-in-eu-project-demonstration-city-tampere.html</p>



Figure 5-1. Nature-based solutions in Vuores Central Park (© City of Tampere).

5.1.2 Recommended indicators case study from Valladolid, Spain

<p>NBS name and location</p>	<p>Urban carbon sink Valladolid Demo Site. The Urban Carbon Sink is located in the eastern part of the municipality of Valladolid, in the neighbourhood known as Los Santos-Pilarica (Sector 50, "Los Santos 2").</p>
<p>Brief description of NBS</p>	<p>The Urban Carbon Sink (UCS; Figure 5-2) is conceived as an urban forest in which species have been selected mainly for their ability to fix carbon. Therefore it is a nature-based solution for the over-accumulation of carbon dioxide in cities' atmosphere.</p> <p>The design of the UCS is embedded into another projected NBS, the Floodable Park. It will consist in the installation of urban woodland (initially planned planting 1,500 trees in a 40,000 m² surface) with appropriate species adapted to temporary flood condition and with high capacity of carbon sequestration (<i>Fraxinus</i> spp., <i>Betula</i> spp., <i>Salix</i> spp., <i>Populus</i> spp., etc.). Trees of this forest will be allocated in specific arboreal series.</p> <p>This area will be a new urban carbon sink and will form a new urban ecosystem to preserve the biodiversity. Likewise, this woodland will provide biomass to energy use with social and economic purposes.</p> <p>Expected impacts: The UCS will be located close to industrial and traffic areas, which act as a source of carbon dioxide emissions due to combustion processes. This NBS is proposed to compensate the emissions of this greenhouse gas, capturing it in the form of biomass.</p> <p>In order to achieve this effect, it is necessary to include specific criteria for taxon selection composition and typology of them during designing stage of UCS. Likewise, it will be essential to take into account to establish a management plan (pruning, spacing, etc.).</p> <p>Multicriteria species assessment is required, focused on C fixation capacity, in addition with other aspects, such as native vegetation, easy management, aesthetics, health, ecological coherence and integrity criteria. Impacts derived from UCS implementation must be evaluated on medium-long term, since to C fixation capacity of the species is highly related to the maturity grade of the taxa.</p>



Figure 5-2. Urban Carbon Sink conceptual design (URBAN GreenUP project)

<p>Indicators of relevance</p>	<p>1.1 Total carbon removed or stored in vegetation and soil per unit area per unit time Temperature decrease Heatwave risk Green space distribution (m²/capita) Green space distribution (km cycle lane/capita)</p> <p>7.1 Green space accessibility Green areas sustainability Elderly people life quality</p> <p>9.1 Green infrastructure connectivity Pollinator species increase</p>
<p>Explanation for selection of Indicators</p>	<p>This NBS will improve the accessibility to green space value in the area for the surrounded population, with 40.000 m² of new available green space.</p> <p>Other indicators that are related with this NBS are those related with Carbon storage, as it is the main purpose of this NBS.</p>
<p>Description of Indicator Application</p>	<p>In this case, the main indicator for impact assessment is 01.01 and 01.02 and additionally the other ones. This indicator will need an spatial and statistical analysis, following the following algorithm (Figure 5-3):</p>

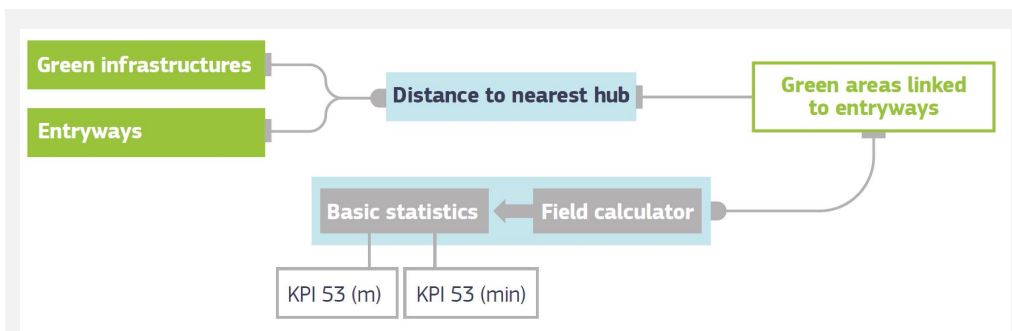

Figure 5-3. Suggested algorithm for the QGIS process as defined in Deliverable D2.4: Monitoring Program to Valladolid from the URBAN GreenUP Project.

In this case, “Green infrastructures” is referred to the arriving point and “entryways” to departure point.

Stakeholders involved	Different municipality areas (at least urbanism, environment and heritage), car park property, construction and gardening companies, River Duero Basin (it is located in the Esgueva River bank).
Barriers encountered and lessons learned	Main barriers are located in the availability of data required for this Indicator.
Case study authors	Raúl Sánchez ¹ , Jose Feroso ¹ , Francisco Verdugo ¹ , Raquel Maríjuan ¹ , Silvia Gómez, María González ¹ , José María Sanz ¹ , Esther San José ¹ ¹ CARTIF Foundation. P.T. Boecillo, 205, 47151, Boecillo, Valladolid, Spain

5.1.3 Recommended indicators case study from Guildford, UK

NBS name and location	Roadside green infrastructure Guildford, UK
-----------------------	---

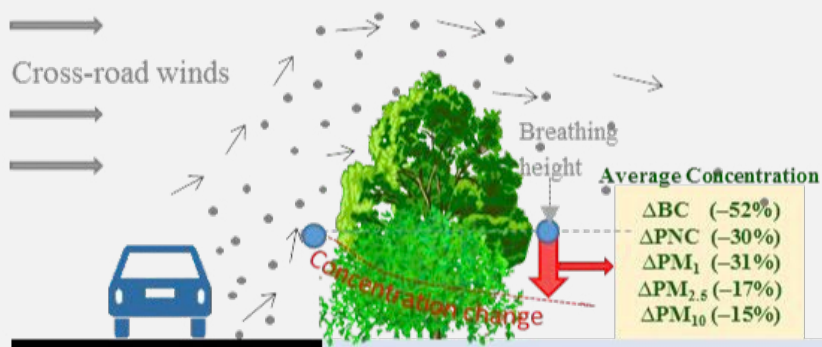

Figure 5-4. Roadside green infrastructure.

Brief description of NBS

Roadside Green Infrastructure (Figure 5-4) includes trees, hedges, individual shrubs, green walls, and green roofs. The focus of the iSCAPE pilot in Guildford (UK) was air pollution abatement and in specific on particulate matter (PM), which is composed of particles such as black carbon (BC). The pilot focused on near-road environments, where vegetation can act as a barrier between traffic emissions and pedestrians (figure below), by collecting pollutants and/or redirecting the flow of polluted air (Abhijith et al., 2017; Kumar et al., 2019; Riondato et al., 2020; Tiwari et al., 2019). This study performed as part of iSCAPE (GA n° 689954) pioneered the adoption of this kind of nature based solution as a passive control system for roadside pollution in urban street canyon and open road settings.

The pilot assessed through monitoring and modelling different combinations of trees, hedges and individual shrubs to assess their performances in urban street canyon and open road settings in terms of abatement of road traffic particulate matter (PM).

Project results show that green barriers can produce a reduction of concentration of Black Carbon up to 52%, PM₁ up to 31%, PM_{2.5} up to 17%, PM₁₀ up to 15%.

A series of design parameters were also created for both urban street canyon and open road settings to help planners in the effective deployment of this kind of air pollution abatement intervention (Kumar et al., 2019):

Considerations for urban street canyon green infrastructure

Design parameter	Considerations
Location	If the prime objective is to reduce exposure for pedestrians or cyclists, hedges should be planted close to the road, between the

	road and footpath/bike path. Green walls can be constructed on the pillars of flyovers, retaining walls and other boundary walls.
Selection of vegetation	In deep street canyons, no forms of vegetation except green walls are recommended. In mid-depth street canyons (Table 4), shrubs or hedges and green walls can be planted, but trees are not recommended. Large, dense trees should be avoided in all street canyons, but smaller or lighter-crowned trees may be planted in shallow street canyons.
Spacing	Continuous hedges (with no gaps or spacing) provide a better reduction in exposure for pedestrians and cyclists. If trees are to be planted (shallow canyons only), they should be spaced generously apart from one another.
Height	For hedges, a height of around 2m is recommended.
Thickness	For hedges, a thickness of 1.5m or more is recommended.
Density	In street canyons, a higher density for hedges and lower density for trees is recommended.

Considerations for open road green infrastructure

Design parameter	Considerations
Location	Hedgerows should be planted between the road and walkways or dwellings and in front of trees (if present); this configuration offers the maximum reduction of exposure.
Spacing	Barriers with no gaps provide better downwind exposure reduction.
Height	Where possible, it is recommended that the combined hedge-tree barrier or green wall has a height of 5m or more. Vegetation barriers with greater height result in increased pedestrian-side pollutant reductions. A minimum height of 1.5m is recommended.
Thickness	The vegetation should be as thick as possible; thicker vegetation barriers offer greater exposure reduction. If possible, a thickness of more than 5m is recommended.
Density	High-density vegetation barriers are generally better for reducing exposure levels downwind.

Indicators of relevance

Monetary values: value of air pollution reduction; total monetary value of urban forests including air quality, run-off mitigation, energy savings, and increase in property values.

11.1 Air quality parameters (Particulate Matter)[†]

Concentration of particulate matter (PM_{2.5} and PM₁₀) at respiration height along roadways and streets.

[†]*Contributes to evaluating indicators 12.7/12.8*

Explanation for selection of Indicators

In future, if this NBS is widely installed it can be used recommended indicators for Air Quality challenges (Figure 5-5). Recommended indicators have a scale of measurement from district to region and they have not sensibility enough to study the impact of this NBS. Therefore, in the meantime it is needed additional indicators to assess the impact on air pollutants emission reduction with indicators such as the ones mentioned before.

Description of Indicator Application	<p>In this case, the main indicators for impact assessment is 6.11 and 6.13. 6.11 implies the installation of sensors for continuous monitoring of PM on the two sides of the deployed green barrier NBS.</p> <p>It is also recommended to complement the monitoring campaign with modelling to account for the impact of local climate.</p>
Stakeholders involved	<p>A wide range of stakeholders including local authorities, academia and local community which were involved in co-design and co-monitoring activities.</p>
Barriers encountered and lessons learned	<p>The main challenge was the initial engagement of the stakeholders for the co-design and co-monitoring activities part of the Living Lab framework embraced by iSCAPE. The development of a solid strategy resulted in a very high engagement of the stakeholders in this pilot, which allowed to produce the adequate bottom-up support to push the findings from the pilot into policy within the lifetime of the project. The findings were endorsed and operationalised as policy by the Mayor of London (https://www.london.gov.uk/sites/default/files/green_infrastruture_air_pollution_may_19.pdf). The pilot clearly demonstrated the advantages of involving a wide range of stakeholders in the various stages of the design, development and monitoring of NBS.</p> <p>It also clearly demonstrated the effectiveness, if appropriately deployed, of common elements of green infrastructure as passive control systems for air pollution.</p>
Case study authors	<p>Francesco Pilla¹, Prashant Kumar² ¹<i>Spatial Dynamics Lab, University College Dublin, Ireland</i> ²<i>Global Centre for Clean Air Research, University of Surrey, UK</i></p>
References	<p>Abhijith, K.V., Kumar, P., Gallagher, J., McNabola, A., Baldauf, R., Pilla, F., Broderick, B., Di Sabatino, S. and Pulvirenti, B., 'Air pollution abatement performances of green infrastructure in open road and built-up street canyon environments–A review', <i>Atmospheric Environment</i>, Vol. 162, 2017, pp. 71-86.</p> <p>Kumar, P., Abhijith, K.V. and Barwise, Y., <i>Implementing green infrastructure for air pollution abatement: General recommendations for management and plant species selection</i>, 2019.</p> <p>Riondato, E., Pilla, F., Basu, A.S. and Basu, B., 'Investigating the effect of trees on urban quality in Dublin by combining air monitoring with i-Tree Eco model', <i>Sustainable Cities and Society</i>, Vol. 61, 2020, p. 102356.</p> <p>Tiwari, A., Kumar, P., Baldauf, R., Zhang, K.M., Pilla, F., Di Sabatino, S., Brattich, E. and Pulvirenti, B., 'Considerations for evaluating green infrastructure impacts in microscale and macroscale air pollution dispersion models', <i>Science of The Total Environment</i>, Vol. 672, 2019, pp. 410-426.</p>

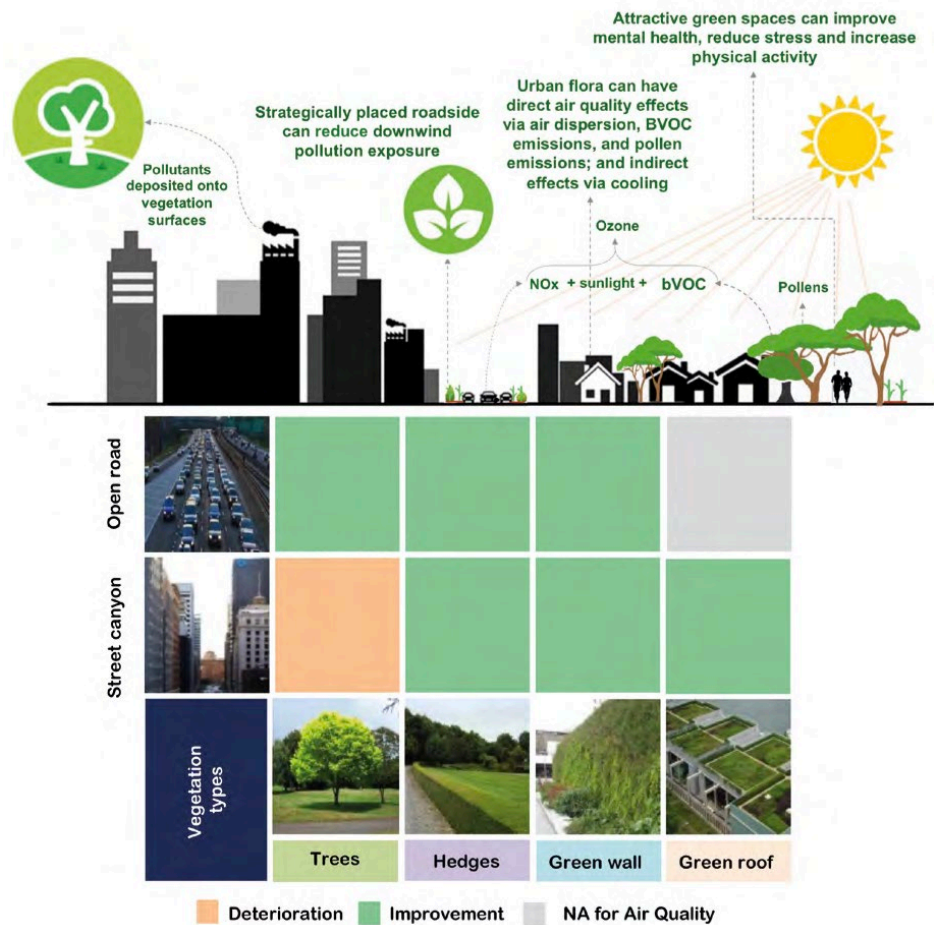

Figure 5-5. An overview of the relationship between air quality and green infrastructure with a matrix offering local-scale implementation impacts (adapted from Abhijith et al. 2017 and Kumar et al. 2019).

5.1.4 Recommended indicators case study from Genk, Belgium

NBS name and location	Schansbroek Park (Genk, Belgium)
Brief description of NBS	Schansbroek Park lies near the source zone of the Stiemerbeek River and near the coal mine of Waterschei. The park is an example of NBS for brownfield regeneration (Figure 5-6), as the area was surrounded by mining activities that were severely affected natural water management contributing to pollution and flooding for local residents (Connecting Nature, 2020). The topography of the area was altered by mining operations and to

	<p>protect local residences, rainfall and groundwater has had to be pumped into the Stiemerbeek River. This severe hydrological impact caused water shortage for natural wetland areas negatively impacting their biodiversity. Regarding its attractiveness, although the area has a 16th century defensive structure 'De Schans', the surroundings were unattractive and there was a lack of recreational infrastructure for visitors, residents and workers (Green4Grey, 2020).</p> <p>In view of the state of the area, the Flemish Land Agency (VLM) together with the city of Genk began a participatory redesign, where the suggestions made by local citizens (i.e., allotments, children's play areas, cycling / hiking trails, picnic and meeting areas) were included in the new plan (Hölscher et al., 2019). In addition, the redesign involved measures to recreate a 'wet ecotope' by restoring a natural dam and ponds, and transforming an artificial reservoir from the former mine (Connecting Nature, 2020).</p> <p>The environmental benefits were powerful, since the biodiversity and natural conservation of the area were optimized, reducing flooding and improving water quality. Furthermore, the fact of regulating the floods provided thermal comfort zones. The benefits were not only in the environmental dimension but also in public governance and wellbeing. The new park enhanced the aesthetics of the area, with new spaces to exercise and meet up. Thus, it became an attractive space for residents and workers of the neighbouring Thorpark that allowed citizens to reconnect with nature, improving physical and mental wellbeing. The fact of having conducted participatory planning contributed to promoting social cohesion and environmental stewardship (Connecting Nature, 2020).</p>
<p>Indicators of relevance</p>	<p>21.1 Level of outdoor physical activity (min/week) 21.2 Level of chronic stress ("Perceived stress") 21.4 Self-reported general wellbeing Frequency of social activities in outdoor spaces</p>
<p>Description of Indicator Application</p>	<p>The indicators selected to assess the health and wellbeing dimension in Schansbroek Park form a coherent framework that allows analysing the NBS effects on citizens.</p> <p>Starting with the level of outdoor physical activity, defined as self-reported participation in organized or unorganized sport or exercise, outdoors, at least once a week (Schipperijn et al., 2013), is a fundamental indicator to discover if the new redesign of Schansbroek Park, with its cycling and hiking routes, improves the healthy habits of users. Knowing the weekly physical activity levels allow a broad vision of the health and well-being of the area, since numerous studies in various countries have shown that access to, and use of, urban green space contributes to increased physical activity, wellbeing, higher rates of recreational walking and reduced sedentary time (Almanza et al., 2012; Braubach et al., 2017; Lachowycz and Jones, 2014; Sallis et al., 2016; Schipperijn et al., 2013; Sugiyama et al., 2014).</p>

Complementarily, the indicator of frequency of social activities in outdoor spaces, follows the same line, since during the participatory design process of the new area of Schansbroek, neighbours and workers suggested including places that allow social interaction. This interaction is now possible in the park and represents a great advance in terms of health and well-being assessment, as green spaces contribute to social cohesion, fostering social interactions and engagement, promoting a sense of community (Jennings and Bamkole, 2019; Prezza et al., 2001).

Chronic stress and self-reported wellbeing complete the vision on the potential impacts of Schansbroek Park can produce in terms of well-being, specifically mental health. A growing body of empirical evidence documents the relationship between connection and contact with green spaces and a greater subjective well-being (Frumkin et al., 2017; Howell et al., 2011; Howell and Passmore, 2013; Larson et al., 2016; MacKerron and Maurato, 2013; Pritchard et al., 2020; Wendelboe-Nelson et al., 2019; Zhang et al., 2014). Contact with natural urban environments can provide psychological relaxation and stress alleviation, enhancing immune function, stimulating social cohesion, supporting physical activity, and reducing exposure to air pollutants, noise and excessive heat (Braubach et al., 2017; Hartig et al., 2014).

In addition, other indicators were implemented in the field of Health and Wellbeing, corresponding to indicators: Perceived restorativeness of NBS and Incidence of obesity among adults, of the taskforce.

Description of Additional Indicator Application

Methodology and data analysis require high expertise in psychosocial research but quantitative data collection requires no expertise. During the Connecting Nature project, the data gathering is conducted after the NBS implementation, but it allows making comparisons between different areas of the city or population groups (i.e., users versus no users). Indicator application was as follows:

Level of outdoor physical activity (min/week)

- ☒ *Quantitative P:* Scale/Scale inventory/Questionnaire (survey procedure, paper-and-pencil administration, computer-based administration)
 - *T:* *International Physical Activity Questionnaire (IPAQ)* ([International Physical Activity Questionnaires, n.d.](#)). IPAQ (both long - 27 items, and short form - 7 items) assesses physical activity undertaken across a comprehensive set of domains including:
 - leisure time physical activity
 - domestic and gardening (yard) activities
 - work-related physical activity
 - transport-related physical activity

Frequency of social activities in outdoor spaces

- ☒ *Quantitative P:* Scale/Scale inventory/Questionnaire (survey procedure, paper-and-pencil administration, computer-based administration)

- T: Ad hoc question adapted from Bloesma et al. (2018): How often do you intentionally go to a green environment (not your own garden or Schansbroek Park) for social activities (meeting family or friends, chatting with neighbours, having a picnic, playing board games)?

Level of chronic stress ("Perceived stress")

- ☒ *Quantitative P: Scale/Scale inventory/Questionnaire* (survey procedure, paper-and-pencil administration, computer-based administration)
 - T: *Perceived Stress Scale* (Cohen et al. 1983), a self-report measure intended to capture the degree to which persons perceive situations in their life as excessively stressful relative to their ability to cope. Within Connecting Nature, the PSS-10 version was used because it was established as the most recommended form of PSS (as cited in Taylor, 2015, p. 90).

Self-reported general wellbeing

- ☒ *Quantitative P: Scale/Scale inventory/Questionnaire* (survey procedure, paper-and-pencil administration, computer-based administration)
 - T: *Satisfaction with Life Scale* (Diener et al., 1985), a 7-point scale comprising 5 items that measure individual's general satisfaction with own life as a cognitive-judgmental process (i.e., based on a comparison with a standard that individual had set for him/herself).

Perceived restorativeness of NBS

- ☒ *Quantitative P: Scale/Scale inventory/Questionnaire* (survey procedure, paper-and-pencil administration, computer-based administration)
 - T: *Perceived Restorativeness Scale* (the short, PRS - 11) (Pasini et al., 2014), a shorter, parallel version of the Perceived Restorativeness Scale (PRS - 26) (Hartig et al., 1997), developed to address original psychometric limitations; PRS is based on the Attention Restoration Theory (ART; Kaplan, 1995) and its short version measures an individual's perception of 4 restorative factors assumed to be present to a greater or lesser extent in the environment, namely physical and/or psychological "being-away" from demands on directed attention, "fascination" a type of attention assumed to be effortless and without capacity limitations, the "coherence" and "scope" perceived in an environment. Participant's judgments are made on a 0 to 10-point scale.

Incidence of obesity among adults

- ☒ *Quantitative P: Scale/Scale inventory/Questionnaire* (survey procedure, paper-and-pencil administration, computer-based administration)
 - T: *Measurements of Body mass index (BMI)*. A ratio of weight to height that is calculated by the following formula: $BMI = \text{weight (kg)} \div \text{height (m)}^2$. For adults,

	<p>BMI's in the range of 18.5 to 24.9 are considered to be healthy – and associated with the lowest risk of mortality and morbidity. Overweight is defined as a BMI of 25.0 to 29.9; obesity is defined as a BMI of at least 30, with 3 sub-categories (Class I, Class II, and Class III) that are associated with increasing risk of cardiovascular disease, type 2 diabetes, and all-cause mortality (Bhrem and D'Alessio, 2014).</p>
Stakeholders involved	<p>Connecting Nature; Stad Genk; Green4Grey; the Flemish government</p>
Barriers encountered and lessons learned	<p>Genk was formerly seen as a Grey City (dominated by hard infrastructure), with certain areas of the city disconnected. This made community participation or sense of ownership more difficult (van de Sijpe et al., 2019). In this sense, community opinion regarding the site already used was a barrier, local residents unofficially used the space and there was a lack of interest in draining their private gardens. However, the biggest barrier was the cost of the original design. This plan sought to divert pumped water back to a pond in the nature reserve to raise the water levels in order to meet ecological goals, but it became cost-prohibitive, and mono-functional, so the plan had to change.</p> <p>The lessons learned encompass this change in the redesign of the area, since less expensive measures were taken but that met the same objectives, in addition to enhancing the ecological and social value of the area (van de Sijpe et al., 2019). Active horizontal cooperation between several departments was needed, as well as workshops with the residents of the neighbourhood to explain the project and encourage them to participate in its co-design. Schansbroek was the first area to be redeveloped in the Stiemervallei context, so the lessons learned in terms of project management, stakeholder engagement and citizen communication will be of great use to scale up in other areas of the city.</p>
Case study author	<p>Adina Dumitru¹ (adina.dumitru@udc.es), David Tomé-Lourido¹, Peter Vos², Katrien van de Sijpe² ¹University of A Coruña, Spain ²City of Genk, Belgium</p>
References	<p>Almanza, E., Jerrett, M., Dunton, G., Seto, E., and Pentz, M.A., 'A study of community design, greenness, and physical activity in children using satellite, GPS and accelerometer data', <i>Health and Place</i>, Vol. 18, 2012, pp. 46-54.</p> <p>Bloemsmas, L.D., Gehring, U., Klompmaker, J.O., Hoek, G., Janssen, N.A., Smit, H.A., Vonk, J.M., Brunekreef, B., Lebret, E., and Wijga, A.H., 'Green space visits among adolescents: frequency and predictors in the PIAMA birth cohort study', <i>Environmental Health Perspectives</i>, Vol. 126, No 4, 2018, Art. No 047016.</p> <p>Braubach, M., Egorov, A., Mudu, P., Wolf, T., Ward Thompson, C., and Martuzzi, M., 'Effects of Urban Green Space on Environmental Health, Equity and Resilience', <i>Nature-Based Solutions to Climate Change Adaptation in Urban Areas: Linkages between Science, Policy and Practice</i>, SpringerOpen, Cham, 2017, pp. 187-205.</p> <p>Brehm, B.J. and D'Alessio, D.A., 'Environmental factors influencing obesity', <i>Endotext</i>, MDText.com, Inc., South Dartmouth, 2014, pp. 2000.</p>

- Cohen, S., Kamarck, T., and Mermelstein, R., 'A global measure of perceived stress', *Journal of Health and Social Behavior*, Vol. 24, No 4, 1983, pp. 385-396.
- Connecting Nature, 'Schansbroek, Genk – brownfield regeneration', 2020. Retrieved from <https://connectingnature.eu/oppla-case-study/19379>
- Diener, E., Emmons, R.A., Larsen, R.J., and Griffin, S., 'The Satisfaction With Life Scale', *Journal of Personality Assessment*, Vol. 49, No 1, 1985, pp. 71-75.
- Frumkin, H., Bratman, G.N., Breslow, S.J., Cochran, B., Kahn, P.H., Jr., Lawler, J.J., Levin, P.S., Tandon, P.S., Varanasi, U., Wolf, K.L., and Wood, S.A., 'Nature Contact and Human Health: A Research Agenda', *Environmental Health Perspectives*, Vol. 125, No 7, 2017, pp. 075001.
- Green4Grey, 'Schansbroek (Genk)', 2020. Retrieved from <https://green4grey.be/en/project-zones/schansbroek-genk>
- Hartig, T., Korpela, K., Evans, G.W., and Gärling, T., 'A measure of restorative quality in environments', *Scandinavian Housing and Planning Research*, Vol. 14, No 4, 1997, pp. 175-194.
- Hartig, T., Mitchell, R., de Vries, S., and Frumkin, H., 'Nature and Health', *Annual Review of Public Health*, Vol. 35, 2014, pp. 207-228.
- Howell, A.J., Dopko, R.L., Passmore, H.-A., and Buro, K., 'Nature connectedness: Associations with well-being and mindfulness', *Personality and Individual Differences*, Vol. 51, No 2, 2011, pp. 166-171.
- Howell, A.J. and Passmore, H.-A., 'The nature of happiness: Nature affiliation and mental well-being', *Mental well-being: International contributions to the study of positive mental health*, Springer, New York, pp. 231-257.
- Jennings, V. and Bamkole, O., 'The relationship between social cohesion and urban green space: An avenue for health promotion', *International Journal of Environmental Research and Public Health*, Vol. 16, No 3, 2019, pp. 452.
- Kaplan, S., 'The Restorative Benefits of Nature: Toward an Integrative Framework', *Journal of Environmental Psychology*, Vol. 15, 1995, pp. 169-182.
- Lachowycz, K. and Jones, A., 'Does walking explain associations between access to greenspace and lower mortality?', *Social Science and Medicine*, Vol. 107, pp. 9-17.
- Larson, L.R., Jennings, V., and Cloutier, S.A., 'Public Parks and Wellbeing in Urban Areas of the United States', *PLoS ONE*, Vol. 11, No 4, 2016, e0153211.
- MacKerron, G. and Mourato, S., 'Happiness is greater in natural environments', *Global Environmental Change*, Vol. 23, No 5, 2013, pp. 992-1000.
- Pasini, M., Berto, R., Brondino, M., Hall, R., and Ortner, C., 'How to measure the restorative quality of environments: The PRS-11', *Procedia-Social and Behavioral Sciences*, Vol. 159, 2014, pp. 293-297.
- Prezza, M., Amici, M., Roberti, T., and Tedeschi, G., 'Sense of community referred to the whole town: Its relations with neighboring, loneliness, life satisfaction, and area of residence', *Journal of Community Psychology*, Vol. 29, No 1, 2001, pp. 29-52.
- Pritchard, A., Richardson, M., Sheffield, D., and McEwan, K., 'The Relationship Between Nature Connectedness and Eudaimonic Well-Being: A Meta-analysis', *Journal of Happiness Studies*, Vol. 21, 2020, pp. 1145-1167.
- Sallis, J., Cerin, E., Conway, T., Adams, M., Frank, L., Pratt, M., Salvo, D., Schipperijn, J., Smith, G., Cain, K., Davey, R., Kerr, J., Lai, P., Mitáš, J., Reis, R., Sarmiento, O., Schofield, G., Troelsen, J., Delfien, V., and Owen, N., 'Articles Physical activity in relation to urban environments in 14 cities worldwide: a cross-sectional study', *The Lancet*, Vol. 6736, 2016, pp. 348.
- Schipperijn, J., Bentsen, P., Troelsen, J., Toftager, M., and Stigsdotter, U., 'Associations between physical activity and characteristics of urban green space', *Urban Forestry and Urban Greening*, Vol. 12, 2013, pp. 109-116.
- Sugiyama, T., Cerin, E., Owen, N., Oyeyemi, A., Conway, T., Dyck, D., Schipperijn, J., Macfarlane, D., Salvo, D., Reis, R., Mitáš, J., Sarmiento, O., Davey, R., Schofield, G., Orzanco-Garralda, R., and Sallis, J., 'Perceived neighbourhood environmental attributes associated with adults' recreational walking: IPEN Adult study in 12 countries', *Health and Place*, Vol. 28C, 2014, pp. 22-30.

Taylor, J.M., 'Psychometric Analysis of the Ten-Item Perceived Stress Scale', *Psychological Assessment*, Vol. 27, No 1, 2015, pp. 90-101.

van de Sijpe, K., Vos, P., Dick, G., Mowat, L., Dziubala, A., Zwierzchowska, I., Vandergert, P., Jelliman, S., Connop, S., Nash, C., and González, G., *Deliverable 9: An interim report on progress towards initiation of city-wide nature-based solutions exemplars*, 2019, CONNECTING Nature, Grant Agreement number 730222.

Wendelboe-Nelson, C., Kelly, S., Kennedy, M., and Cherrie, J.W., 'A scoping review mapping research on green space and associated mental health benefits', *International Journal of Environmental Research and Public Health*, Vol. 16, No 12, 2019, 2081.

Zhang, J.W., Howell, R.T., and Iyer, R., 'Engagement with natural beauty moderates the positive relation between connectedness with nature and psychological well-being', *Journal of Environmental Psychology*, Vol. 38, 2014, pp. 55-63.



Figure 5-6. **Schansbroek Park** (© Green4Grey).

5.2 Case studies illustrating the 'story of an indicator' for some of the additional indicators

The case studies in this section are designed to illustrate the selection and use of Additional indicators from each of the 12 Challenge areas to examine a specific aspect of a given NBS. Each case study details the need for use of an Additional indicator and describes its application and the obtained results (or anticipated results).

It should be noted that NBS exhibit multiple co-benefits, identification of which is of outmost importance for evaluating the wider NBS impact. Case studies for selection of Additional indicators presented herein illustrate the selection of the unique indicators. They merely serve as examples of versatility of the NBS impact assessment approach, which can be tailored to local needs and challenges.

5.2.1 Climate Resilience – Urban Heat Island incidence

<p>NBS name and location</p>	<p>Green façade Valladolid Demo Site Shopping Centre El Corte Inglés, Calle Constitución, 2. 47001 Valladolid (Spain)</p>
<p>Brief description of NBS</p>	<p>Green Facade is a constructive system that allows planting on a vertical façade. This NBS is built with a substructure and a waterproof panel. The substructure is affixed to the façade. The plants grow in a growing medium that is affixed to the panels. The water of the irrigation system nourishes the plants.</p> <p>This green wall was built in collaboration with a private company (<i>El Corte Inglés</i>), and has benefits for every part involved in the project: the mall, renewing the image of the facade and attracting new customers, and the city, improving the air quality, climate regulation, pollination and adding aesthetic values to a grey area in the city centre of Valladolid. This vertical garden covers an area of 350 m² and has more than 14,000 plants (Figure 5-7, Figure 5-8).</p>
<p>Additional Indicators of relevance</p>	<p>1.5 Heatwave incidence 1.13 Urban Heat Island (UHI) incidence 1.15 Mean or peak daytime temperature - 1.15.1 Direct measurement. 6.9 Trends in emissions of NO_x and SO_x 6.10 Monetary values: value of air pollution reduction; total monetary value of urban forests including air quality, run-off mitigation, energy savings, and increase in property values. 6.11 Air quality parameters. NO_x and PM.</p>
<p>Explanation for selection of</p>	<p>In future, if this NBS is widely installed it can be used recommended indicators for climate change and Air Quality</p>

Additional Indicators	challenge. Recommended indicators have a scale of measurement from district to region and they have not sensibility enough to study the impact of this NBS. Therefore, in the meantime it is needed additional indicators to assess the impact on air pollutants emission reduction with indicators such as the ones mentioned before.
Description of Additional Indicator Application	In this case, the main indicator for impact assessment is 1.5 and 1.15 (1.15.1) and additionally the other ones. 1.15 implies the installation of several equipment for continuous monitoring of temperature and humidity in the green façade location and reference areas.
Stakeholders involved	Different municipality areas (at least urbanism, environment and heritage), shopping centre company (<i>El Corte Inglés</i>), construction companies.
Barriers encountered and lessons learned	Regarding the NBS implementation, the main barriers were administrative and economic. The green façade was installed in a commercial private building in a relevant area of the city. URBAN GreenUP joined the efforts of the <i>El Corte Inglés</i> technical team, different areas of the Valladolid city council and the technical experts of the Project led by SingularGreen. After more than 1 year of discussions, it was decided to separate into two interventions: A structure to support the NBS and the vertical garden itself. The structure was attached to the existing wall and it was designed and constructed by <i>El Corte Inglés</i> . Then, Green Facade was manage with local and EU funds.
Case study authors	<p>Jordi Serramia¹, Hugo Riquelme¹, Patricia Briega¹, Alicia Villazán², Isabel Sánchez², Elena Sánchez², Juan Carlos Sánchez³, Raúl Sánchez⁴, Jose Feroso⁴, Raquel Marijuan⁴, Silvia Gómez⁴, María González⁴, José María Sanz⁴, Esther San José⁴</p> <p>¹SingularGreen S.L. C/ Francisco Carratalá Cernuda, 34 Bajo, 03010, Alicante, Spain</p> <p>²VALLADOLID City Council. Plaza Mayor 1, 47001, Valladolid, Spain</p> <p>³Tierra Ingeniería S.L. C/ Copenhague, 6, 28230, Las Rozas, Spain</p> <p>⁴CARTIF Foundation. P.T. Boecillo, 205, 47151, Boecillo, Valladolid, Spain</p>



Figure 5-7. The green façade at El Corte Inglés, Valladolid.

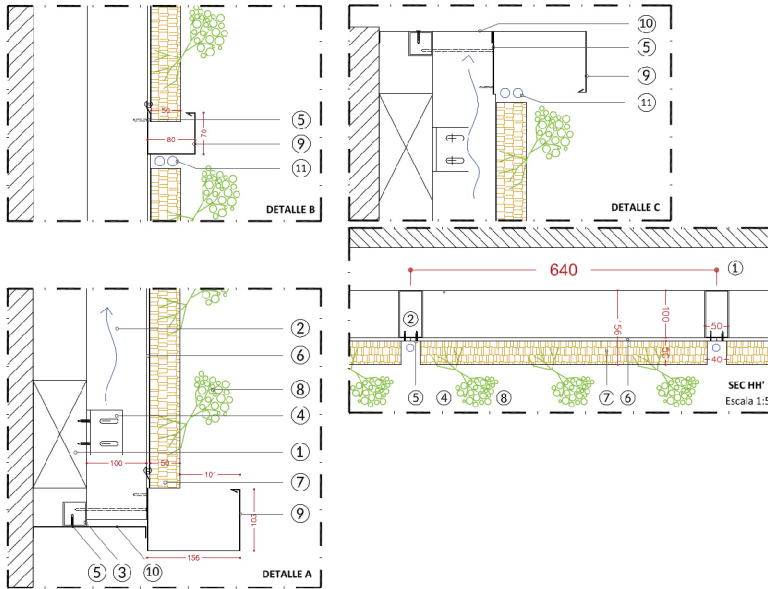

LEGEND

- | | |
|--|---|
| <ul style="list-style-type: none"> 1- Support structure planned for vertical garden anchoring 2- Vertical garden substructure. Aluminum upright 100x50.2mm 3- Square section aluminum profile for anchoring the garden finishing perimeter sheet 4- Galvanized steel anchor bracket with dimensions 60x60x100.2mm 5- Zinc steel self-tapping screw 6- 5mm thick foamed PVC panel screwed to uprights 7- Substrate made of rock wool panels of 80kg / m3. 50mm | <ul style="list-style-type: none"> 8- Vegetation selected by SingularGreen S.L. 9- 1.5 thick aluminium gutter, lacquered. Color to be chosen by the Facultative Direction 10- Lacquered aluminium sheet for vertical garden perimeter finishing 190x20mm. Self-tapping anchored to aluminium profile. Color to be chosen by the Facultative Direction 11- Irrigation pipe SG-R16, self-compensating drippers 1.6l / h every 20 cm |
|--|---|

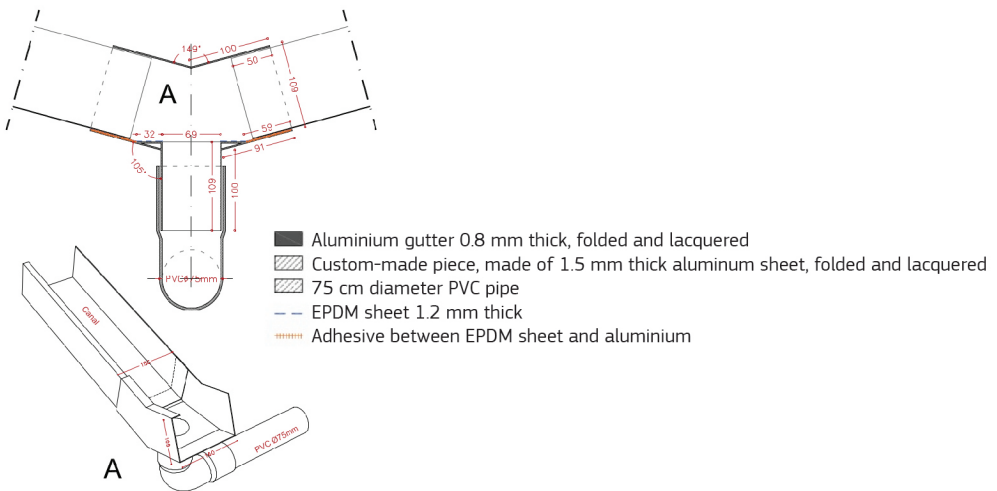

Figure 5-8. URBAN GreenUP Project: Green Façade construction details (© SingularGreen).

5.2.2 Natural and Climate Hazards – Flood risk

NBS Name and Location	Green barrier Gudbrandsdalen Valley, Norway
Brief description of NBS	<p>A receded green flood barrier located at Jorekstad in Lillehammer municipality (Figure 5-9) is proposed to reduce the risk of floods due to snow melting and extreme rainfall. The NBS consists of removing the existing flood protection along a section of the riverbank, and building a new flood barrier, using only natural and local materials, further upland of the riverbanks. This will provide space for the river during periods of flooding and improve the capacity for upstream flood levels, as well as contribute positively to the flood plain ecosystem. For more information see: https://phusicos.eu/case_study/valley-of-gudbrandsdalen-norway/</p>
Additional Indicators of relevance	<p>Risk reduction:</p> <ul style="list-style-type: none"> 6.13.1 Urban /Residential Areas 6.13.2 Productive Areas (Agriculture, Grazing, Industries) 6.15.1 Inhabitants 6.15.3 Other People (Workers, Tourists, Homeless) 6.15.4 Elderly, children, disabled 6.16.1 Population 6.17.1 Housing 6.17.2 Agricultural and Industrial Buildings 6.18.1 Roads 6.18.2 Transportation Infrastructures and Lifelines 6.18.3 Lifelines (Water main, Sewerage, Pipeline, etc.) 6.19.1 Buildings 6.22 Flooded Area 6.24 Peak Flow 24.24 Economic Value of the Productive Activities Vulnerable to Risk (i.e. Economic Value of the Fields, Workers No.) <p>Technical and feasibility aspects:</p> <ul style="list-style-type: none"> 14.22 Material used coherence 24.5 Initial costs 24.6 Maintenance costs 24.7 Replacement costs 24.8 Avoided costs 24.9 Payback Period <p>Environment and ecosystem:</p> <ul style="list-style-type: none"> 4.48 Physical parameters 4.48 Chemical Pollution Parameters 4.23 Water Storage Capacity Enhancement 6.41 Total Predicted Soil Loss (RUSLE) 10.22 Typical Vegetation Species Cover 10.3.1 Abundance of Ecotones/Shannon Diversity

	<p>10.25.1 Diversity of Functional Groups (Plant Functional Diversity) 10.25.2 Diversity of Functional Groups (Animal Functional Diversity) 10.7.1 Sites of Community Importance (SCI) And Special Protection Areas (SPA)</p> <p>Society: 8.31.2 Number of Visitors in New Recreational Areas Different Activities Allowed in New Recreational Areas 8.35.1 New Pedestrian, Cycling and Horse Paths 23.2 Rate of Increase in Properties Incomes 18.1.1 Citizen Involved 18.1.2 Stakeholders Involved 17.3 Public-Private Partnership Activated 17.4 Policies Set Up to Promote NBS 14.7 Social Active Associations 14.17 Natural and Cultural Sites, Made Available 14.25 Viewshed 14.26 Scenic Sites and Landmark Created</p> <p>Local economy: 24.18 Jobs Created in The Nature-Based Sector 24.19 Jobs Created in The Nature-Based Solution Construction and Maintenance 24.17 Gross Profit from Nature-Based Tourism 24.15 Touristic Activeness Enhancing 24.33 New Areas Made Available for Traditional Activities (Agriculture, Livestock, Fishing, ...)</p>
<p>Explanation for selection of Additional Indicators</p>	<p>The indicators tailored to this case study encompass a total of 47 indicators. The indicators are aggregated to provide information about the NBS with respect to five ambits: 1) Risk reduction, 2) Technical and feasibility aspects, 3) Environment and ecosystem, 4) Effects on the society, and 5) Effects on local economy. These five ambits form the basis of the NBS assessment framework developed in the PHUSICOS project (www.phusicos.eu).</p>
<p>Description of Additional Indicator Application</p>	<p>Quantitative, risk-related indicators include Peak Flow volume, Flooded Area – calculated through hydraulic modelling – and Exposed residential and productive areas, obtained by GIS mapping. Ecosystem indicators are aimed to assess both the effects on water quality, such as the Change in physical and chemical water parameters, and water quantity, such as the Total predicted soil loss (RUSLE), or enhanced Water storage capacity. Indicators for assessing the improved value of the forested floodplain include Typical vegetation species cover, and Diversity in plant and animal functional groups. Societal-related indicators include the Number of visitors in the new recreational areas and New pedestrian/cycling paths, whilst the Number of jobs created in the nature-based sector is one of the economy-related indicators.</p>

Stakeholders involved	Innlandet County Administration, Lillehammer municipality, Private land owners, Local farmers' association, Norges Naturvernforbund (Friends of the Earth Norway, an environmental and nature protection NGO)
Barriers encountered and lessons learned	<p><u>Barriers encountered:</u></p> <p>The tendering process for procurement of goods and services is often not straightforward, there are complaints from bidders who were not selected, etc.</p> <p>Local politics and bureaucracy; revision of land use plans, local elections, etc.</p> <p>Land owners resisting use of their land, for various reasons, e.g.</p> <ul style="list-style-type: none"> ○ Loss of agricultural land ○ General scepticism to NBS, or lack of knowledge ○ Economic reasons; want land compensation, lose extra income from gravel out-take <p><u>Lessons learned:</u></p> <ul style="list-style-type: none"> • Plan well ahead. Getting plans through to practical implementation takes more time than one possibly could think of. • Bring stakeholders into the process as early as possible, if possible from scratch; co-creation and co-design of the measures establishes 'ownership' and increases enthusiasm. • Use their local knowledge wherever possible and show appreciation. • Identify potentially 'problematic' stakeholders and plan strategies to handle these. • If at all possible, choose public land for your NBSs. • Identify individuals who can be good ambassadors for the project and work closely with them. • Procurement can be time consuming. Be as detailed as possible in the tender documents. Complaints will lead to serious delays.
Case study author	Vittoria Capobianco (vittoria.capobianco@ngi.no) <i>Norwegian Geotechnical Institute, Norway</i>
Reference	https://phusicos.eu/case_study/valley-of-qudbrandsdalen-norway

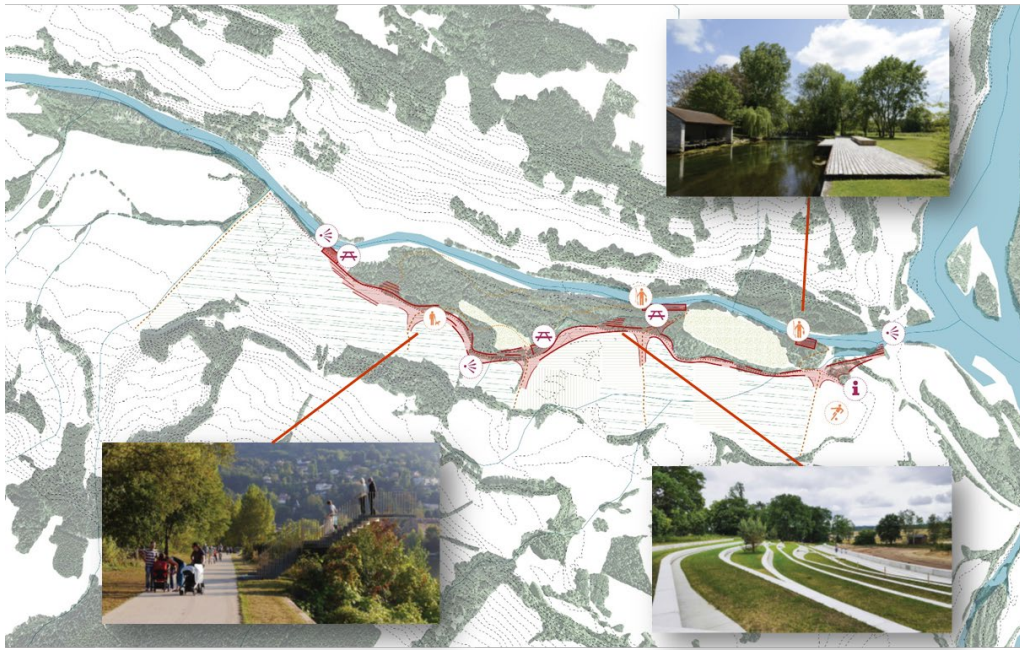
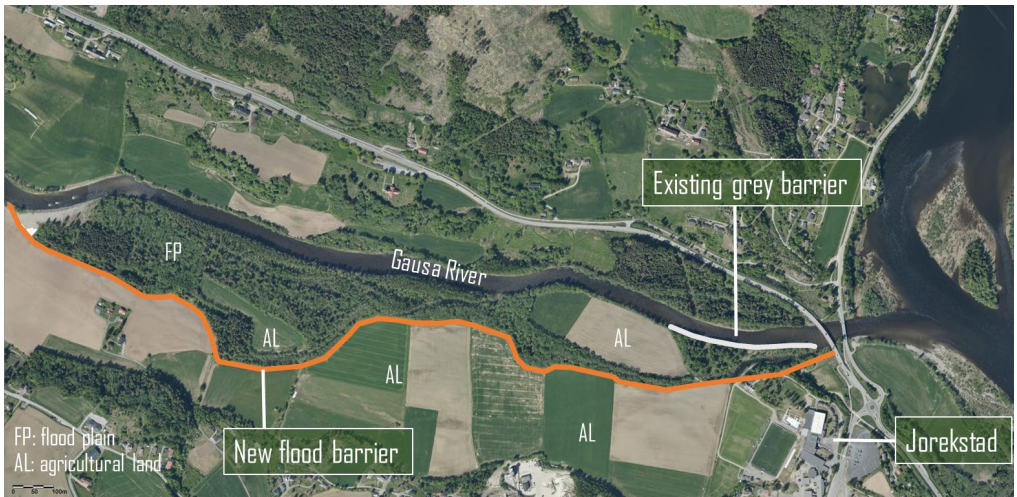

Figure 5-9. Aerial photo of the area with the location of the existing flood barrier and the new flood barrier (top); visualization of the area with the potential multiple actions that can be supported by the flood barrier (by Agence Ter, bottom).

5.2.3 Green Space Management – Walkability

NBS Name and Location	Living Lab districts Turin (Italy), Zagreb (Croatia), Dortmund (Germany), Ningbo (China)
Brief description of NBS	During the proGIreg project, this indicator will be calculated for the Living (LL) district and for the entire city area in each Front-Runner City (FRC).
Additional Indicators of relevance	8.37 Walkability
Explanation for selection of Additional Indicators	The Walkability index express the likelihood that a particular area may be covered by walking. It provides additional information on the urban structure of a city and, in turn, individual districts. Additionally, it can be of useful in assess the effects of Land use changes (pre/post intervention)
Description of Additional Indicator Application	<p>The Walkability index is a GIS derived raster image, function of connectivity, accessibility and perceived pleasantness with values ranging from 0 to 1 where 1 indicates the most walkable area (e.g., a park with pedestrian lanes well connected to city hot spots like residential and working areas) and 0 indicates the least walkable area (e.g., a major urban road) (Figure 5-10).</p> <p>The calculation of the Walkability index requires the following data:</p> <ul style="list-style-type: none"> ○ Pop Density map ○ Road Network ○ Public Transit (including stops and routes) ○ Land Use and zoning: residential, commercial and office, industrial, institutional (e.g., schools, libraries, kindergartens), green/park area, and water and wetland ○ Digital elevation model

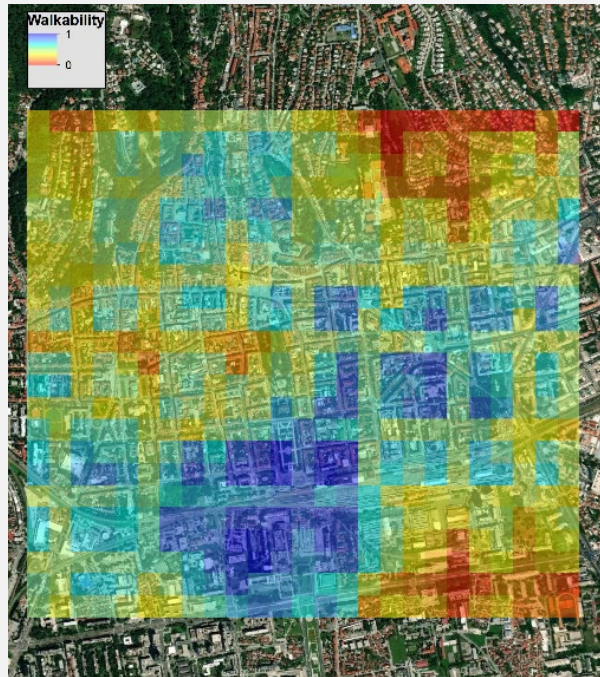

Figure 5-10. Example of walkability index (city of Zagreb – preliminary results by Vincenzo Giannico, University of Bari).

Stakeholders involved

Civil local authorities for data collection during baseline have been involved

Barriers encountered and lessons learned

The walkability index is a derived metric that requires a large number of input data. This characteristic leads to two major issues: (1) data availability and (2) data harmonization across the civil local authorities involved.

To date, only two of the four FRCs (i.e., Zagreb and Dortmund) sent us the requested data. Additionally, of the received data, only the files received by the city of Zagreb were actually usable as the rest of the files were not compliant with the model request and thus were not useful. However, the problem was discussed with the local authorities of Dortmund, and they assured that the data will be provided in the correct data type within a short period of time. The city of Turin, similarly, is committed to provide the data as soon as possible.

Another issue concerns the harmonization of data across cities. Given the nature of the input data involved in the calculation of the Walkability index, it has been found to be difficult to obtain data acquired in the same year across cities. For example, the Land Use map provided by city of Zagreb is from 2012 while the city of Dortmund provided a Land Use map generated in the first decade of the 2000s. Land Use maps, in particular, are usually developed on a multiyear basis by local authorities, as the changes in land use occurring yearly, especially in European cities, are

	<p>often limited. As a consequence, we will be unable to calculate a yearly walkability index, as expected initially, but rather one walkability index before the initiation of the project and, depending on the availability of the data, another walkability index at the end of the project.</p> <p>Lesson learned:</p> <ul style="list-style-type: none"> ○ Data collection can vary across cities and constant interaction with local authorities is needed. ○ Given the nature of the input data, calculating a yearly walkability index is not feasible. ○ Two Walkability index (pre/post intervention) would be calculated on the basis of the availability of the data.
Case study author	Vincenzo Giannico (vincenzo.giannico@uniba.it) <i>University of Bari, Italy</i>
References	Fan, P., Xu, L., Yue, W., and Chen, J., 'Accessibility of public urban green space in an urban periphery: The case of Shanghai', <i>Landscape and Urban Planning</i> , Vol. 165, 2017, pp. 177-192.

5.2.4 Green Space Management – Annual Trend in vegetation cover

NBS name and location	This indicator is part of a framework applied at European level to map and assess urban ecosystems condition and ecosystem services
Brief description of NBS	<p>The Green Space Management – Annual Trend in vegetation cover indicator was implemented to assess changes in vegetation cover within the <i>Urban Green Spaces</i> (NBS Type 3) in 700 European Functional Urban Areas (FUAs; Figure 5-11) as part of the Mapping and Assessment of Ecosystems and their Services (MAES) initiative:</p> <p>https://ec.europa.eu/environment/nature/knowledge/ecosystem_assessment/index_en.htm</p>

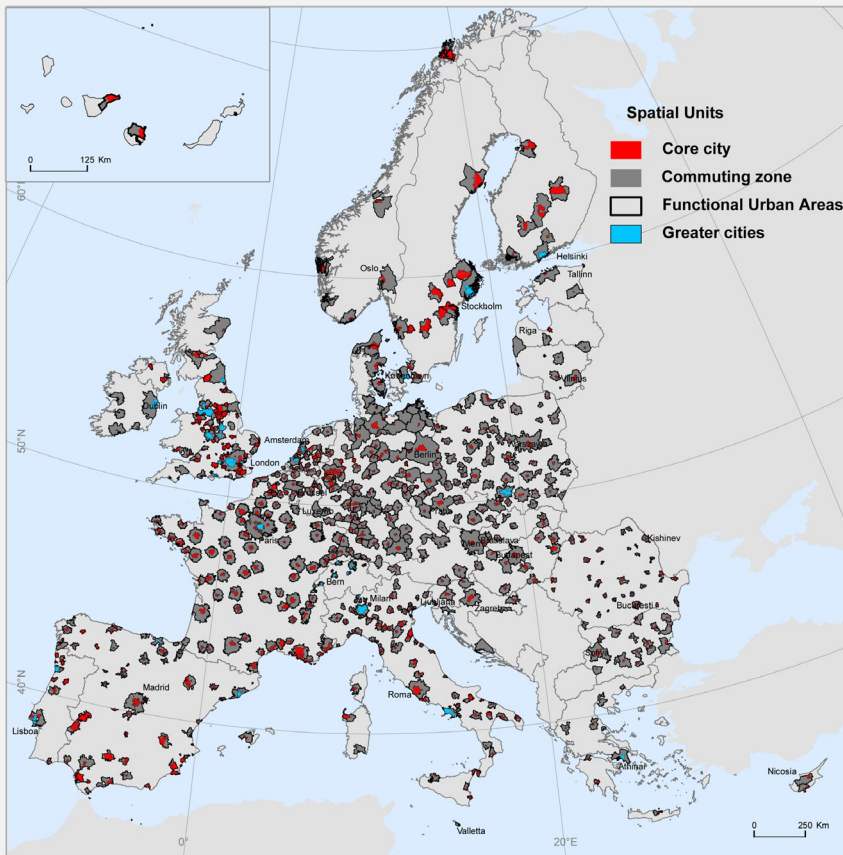

Figure 5-11. Distribution of European functional urban areas (FUAs; (EU 28 + Norway and Switzerland) (source: Maes et al., 2020, Chapter 3.1: Urban Ecosystems).

Additional Indicators of relevance

- At European level the following indicators have been implemented:
- 7.1 Green spaces Accessibility
 - 7.2 Share of green urban areas
 - 8.1 Ecosystem services provision (flood control, nature-based recreation, pollination)
 - 8.2 **Annual trend in vegetation cover by urban green infrastructure**
 - 8.31.1 ESTIMAP nature-based recreation
 - 8.38 Land composition
 - 8.39 Land use change and green space configuration
 - 8.40 Soil sealing

Explanation for selection of Additional Indicators

We defined Urban Green Spaces in European cities according to the EU GI Strategy (EC, 2013), as “a strategically planned network of natural and semi-natural areas with other environmental features designed and managed to deliver a wide range of ecosystem services” (EC, 2013). We carried out the analysis including all natural and semi-natural areas together with all private and public green spaces within the core cities and the commuting zones.

The capacity of Green Spaces to provide ecosystem services is linked to the quality and extent of vegetation cover. This indicator

examines how and in which direction vegetation cover changed between 1996 and 2018. Trend detection in Normalized Difference Vegetation Index (NDVI) time series can help to identify and quantify recent changes in ecosystem properties.

Description of Additional Indicator Application

Figure 5-12 shows the steps needed to derive the indicator.

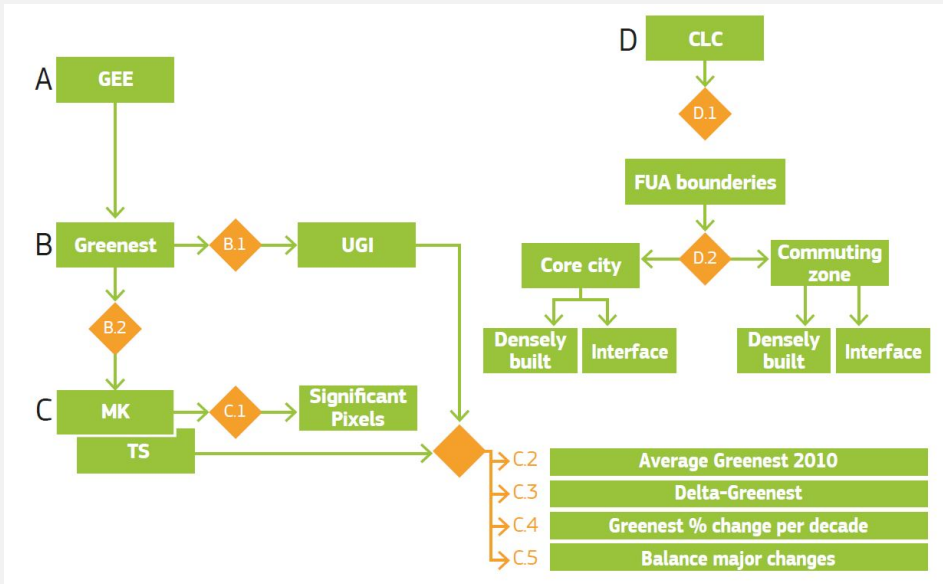

Figure 5-12. Suggested algorithm for the process (source: Maes et al., 2020, Chapter 3.1: Urban Ecosystems, Factsheet 3_1_109).

- A. Data were physically downloaded from Google earth engine (GEE)
- B. From the original maps the Urban green Infrastructure (UGI) mask was created:
 - o B.1. areas where at least once between 1996 and 2018 the highest-NDVI was greater than 0.4.
- C. The Trend analysis employed a non-parametric approach, namely the Theil-Sen regression. The slopes of the regression approach were tested for their statistical significance using the p-value of the Mann-Kendall⁵⁰ test for slopes (Corbane et al., 2018; Forkel et al., 2013; Jin et al., 2019; Novillo et al., 2019; Teferi, et al., 2015; Wang et al., 2018;).
 - o C.1 Only pixels where the p-value (Mann-Kendall) was less than 0.05 (95% confidence interval) have been considered to have a significant medium-term trend and used as a mask to extract all the indicators.
 - o C.2 we reported the average greenest value in 2010 as reference value.
 - o C.3 From the Theil-Sen positive or negative slope we extracted the Delta Greenest, which represent the **change direction** over the 22 years of analysis.
 - o C.4 To make the interpretation easier the annual trends were reported in terms of percentage of change per decade (using the equation proposed by Teferi et al., 2015) .
 - o C.5 The TS-Slope was reclassified in 5 classes representing key gradual to abrupt change types. They were defined using the minimum measurable change (+-0.001)

⁵⁰ Mann-Kendall is a temporal trend estimator that is more robust than the least-squares slope because it is much less sensitive to outliers and skewed data (<https://clarklabs.org/terrset/>).

as thresholds for areas with no changes (Guan et al., 2018; Jin et al., 2019; Verbyla, 2008).

D. CLC map was reclassified using the land mosaic model in Densely built up and interface zone

- o Indicators (C1-C2-C3-C4-C5) were extracted in Core cities and Commuting zone **only for significant pixels of UGI.**

Spatially explicit data are available for the 700 FUA. The indicator could be used at a city level to study vegetation development within urban parks.

Figure 5-13 shows the percentage of change per decade in vegetation cover. 26% of European cities present a downward trend, meaning that there is a tendency to loose vegetation. The balance between abrupt changes (Figure 5-14) confirms the trend.

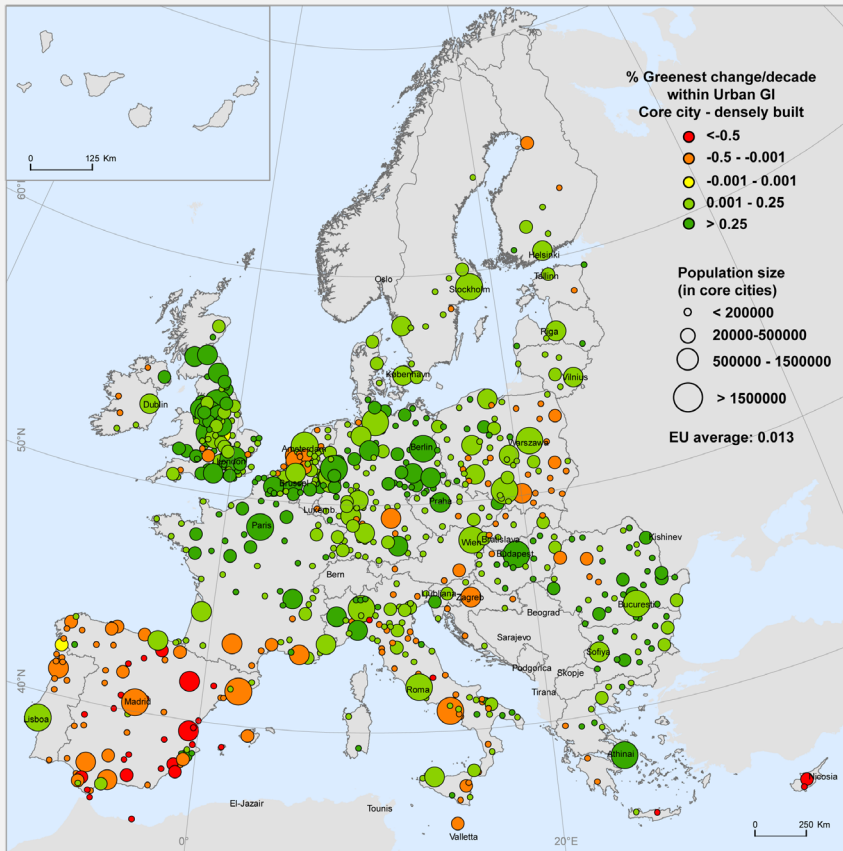

Figure 5-13. Trends in vegetation cover (% change/decade), within densely built areas in core cities. The pie chart shows the proportion of cities for each category (source: Maes et al., 2020, Chapter 3.1: Urban Ecosystems).

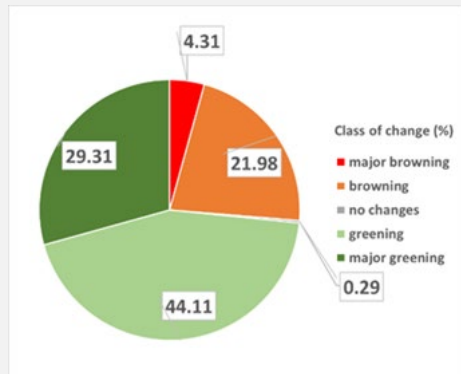

Figure 5-14 shows the difference between major greening and major browning in densely built areas of core cities. It represents a "compensation indicator", if it is positive the upward trend was higher than the downward trend and greening areas compensated the loss of green spaces. If it is negative, the land

development pattern did not include any solution to compensate the green loss. This indicator provide insights at urban/regional/national level about the compensation policies taken to avoid damages created by land take, soil sealing or climate change.

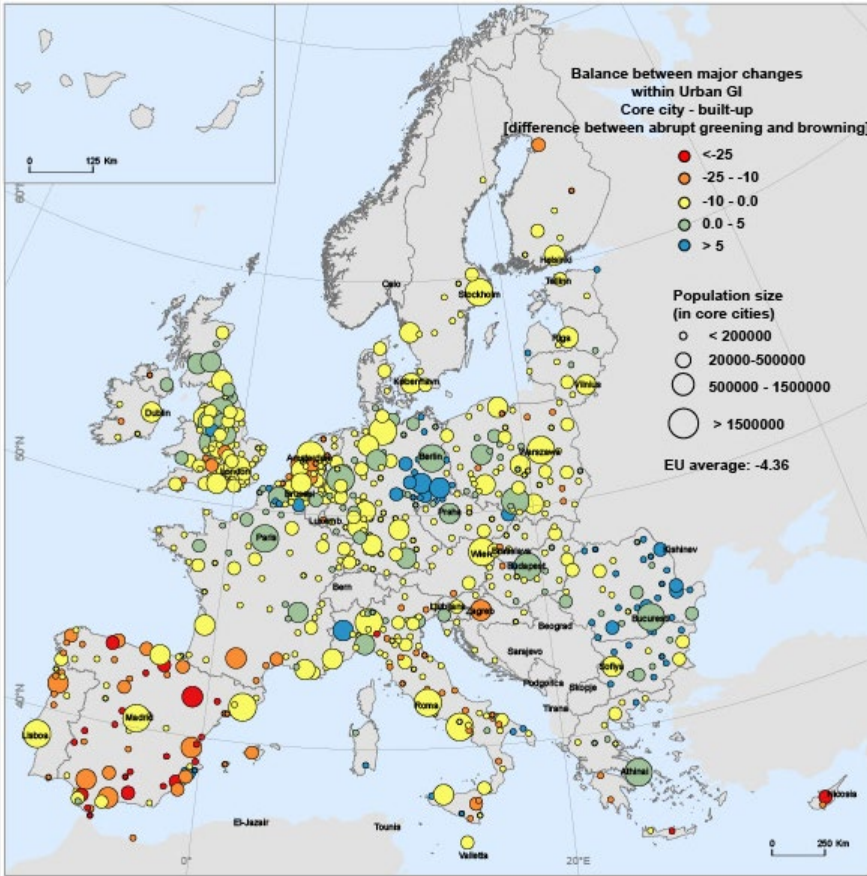
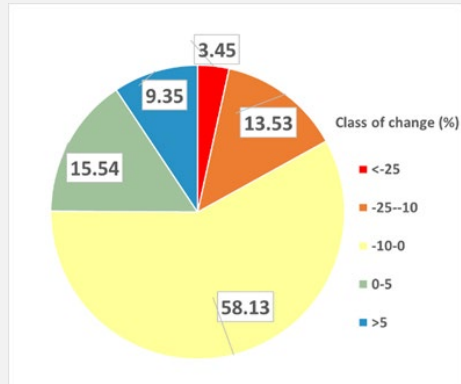

Figure 5-14. Balance between abrupt greening and browning changes within densely built areas in core cities. The pie chart shows the proportion of cities for each category (source: Maes et al., 2020, Chapter 3.1: Urban Ecosystems).



Stakeholders involved

MAES represents the core activity of Action 5 – Target 2 of the EU Biodiversity strategy to 2020. The all process, started in 2013 involved EU Member States, The Commission (DG ENV, DG-JRC), The European Environmental Agency (EEA) and several other stakeholders.

Specifically a workshop, held in Brussels in June 2019, provided the opportunity for stakeholders to engage in the first EU wide ecosystem assessment.

Barriers encountered and lessons learned	Main barriers are linked to: expertise requested for the implementation of the indicator.
Case study author	Grazia Zulian (grazia.zulian@ec.europa.eu) <i>JRC D3 Land Resources</i>
References	<p>Corbane, C., Pesaresi, M., Politis, P., Florczyk, J.A., Melchiorri, M., Freire, S., Schiavina, M., Ehrlich, D., Naumann, G., and Kemper T., 'The grey-green divide: multi-temporal analysis of greenness across 10,000 urban centres derived from the Global Human Settlement Layer (GHSL)', <i>International Journal of Digital Earth</i>, 2018, pp. 101–118.</p> <p>EC, 'Green Infrastructure (GI) — Enhancing Europe's Natural Capital', COM(2013) 249 final, 2013, p. 13.</p> <p>Forkel, M., Carvalhais, N., Verbesselt, J., Mahecha, M.D., Neigh, C.S.R., and Reichstein, M., 'Trend Change detection in NDVI time series: Effects of inter-annual variability and methodology', <i>Remote Sensing</i>, Vol. 5, No 5, 2013, pp. 2113–2144.</p> <p>Jin, J., Gergel, S.E., Lu, Y., Coops, N.C., and Wang, C., 'Asian Cities are Greening While Some North American Cities are Browning: Long-Term Greenspace Patterns in 16 Cities of the Pan-Pacific Region', <i>Ecosystems</i>, 2019, pp. 383–399.</p> <p>Maes, J., Teller, A., Erhard, M., Condé, S., Vallecillo, S., Barredo, J.I., Paracchini, M.L., Abdul Malak, D., Trombetti, M., Vigiak, O., Zulian, G., Addamo, A.M., Grizzetti, B., Somma, F., Hagyo, A., Vogt, P., Polce, C., Jones, A., Marin, A.I., Ivits, E., Mauri, A., Rega, C., Czúcz, B., Ceccherini, G., Pisoni, E., Ceglar, A., De Palma, P., Cerrani, I., Meroni, M., Caudullo, G., Lugato, E., Vogt, J.V., Spinoni, J., Cammalleri, C., Bastrup-Birk, A., San Miguel, J., San Román, S., Kristensen, P., Christiansen, T., Zal, N., de Roo, A., Cardoso, A.C., Pistocchi, A., Del Barrio Alvarelllos, I., Tsiamis, K., Gervasini, E., Deriu, I., La Notte, A., Abad Viñas, R., Vizzarri, M., Camia, A., Robert, N., Kakoulaki, G., Garcia Bendito, E., Panagos, P., Ballabio, C., Scarpa, S., Montanarella, L., Orgiazzi, A., Fernandez Ugalde, O., and Santos-Martín, F., 'Mapping and Assessment of Ecosystems and their Services: An EU ecosystem assessment', EUR 30161 EN, Publications Office of the European Union, Ispra, 2020.</p> <p>Novillo, C., Arrogante-Funes, P., and Romero-Calcerrada, R., 'Recent NDVI Trends in Mainland Spain: Land-Cover and Phytoclimatic-Type Implications', <i>ISPRS International Journal of Geo-Information</i>, Vol. 8, No 1, 2019, p. 43.</p> <p>Teferi, E., Uhlenbrook, S., and Bewket, W., 'Inter-annual and seasonal trends of vegetation condition in the Upper Blue Nile (Abay) Basin: Dual-scale time series analysis', <i>Earth System Dynamics</i>, Vol. 6, No 2, 2015, pp. 617–636.</p> <p>Wang, J., Zhou, W., Qian, Y., Li, W., and Han, L., 'Quantifying and characterizing the dynamics of urban greenspace at the patch level: A new approach using object-based image analysis', <i>Remote Sensing of Environment</i>, Vol. 204, 2018, pp. 94–108.</p>

5.2.5 Green Space Management - ESTIMAP nature-based recreation

<p>NBS name and location</p>	<p>This indicator is part of a framework applied at European level to map and assess urban green spaces and ecosystem services.</p>
<p>Brief description of NBS</p>	<p>The indicator was implemented to assess the capacity of urban ecosystems to provide nature based recreation opportunities in 700 European Functional Urban Areas (FUAs; see Figure 5-11 in case study 5.2.4 Green Space Management – Annual Trend in vegetation cover). This work was part of the EnRoute project: https://oppla.eu/groups/enroute https://publications.jrc.ec.europa.eu/repository/handle/JRC115375</p> <p>Several cities in EnRoute applied the model at a local scale in close collaboration with the municipalities: Poznan: https://oppla.eu/casestudy/19236 Tento: https://oppla.eu/casestudy/19228 Oslo: https://oppla.eu/casestudy/19231</p>
<p>Additional Indicators of relevance</p>	<p>At European level the following indicators have been implemented:</p> <ul style="list-style-type: none"> 7.1 Green spaces Accessibility 7.2 Share of green urban areas 8.1 Ecosystem services provision (flood control, nature-based recreation, pollination) 8.2 Annual trend in vegetation cover in urban green infrastructure <ul style="list-style-type: none"> 8.31.1 ESTIMAP nature-based recreation 8.38 Land composition 8.39 Land use change and green space configuration 8.40 Soil sealing <p>Spatially explicit data are available for the 700 FUA.</p>
<p>Explanation for selection of Additional Indicators</p>	<p>Nature based recreation or “Physical and experiential interactions with natural environment” (CICES, https://cices.eu/) includes a wide list of possible experience and activities such as biking; boating; climbing; hiking; horseback riding, walk the dog in a nice area; enjoy a local play ground ; find an urban park nearby.</p> <p>ESTIMAP nature-based recreation was developed to map the combination of recreation opportunities available in a given location. The original model (Liquete et al., 2016; Paracchini et al., 2014; Vallecillo et al., 2019; Zulian et al., 2013), up to now applied at European scale, was adapted to fit the urban setting. In previous applications the approach was used in urban context (Zulian et al., 2017), but focused only on specific local applications and cities, such as in Barcelona (Baró et al., 2016) or Trento (Cortinovis, Zulian and Geneletti, 2018).</p> <p>Urban ESTIMAP -recreation consists of three basic sections:</p> <ul style="list-style-type: none"> o The Recreation Potential (RP), which estimates the potential capacity of ecosystems to support nature-based recreational activities. It is based on land suitability for recreation and a combination of the natural features that influence recreational opportunity provision (e.g., proximity to lakes; viewpoints of geological or geomorphological interest ...)

- The Opportunity map (OS) expresses the presence of facilities to enjoy and reach areas with potential opportunities.
- The Recreation Opportunity Spectrum map (ROS) combines the Opportunity map (OS) and the Recreation Potential (RP).

From a modelling point of view the whole approach is based on 'Advanced multiple layer Look-up Tables' (LUT) and "proximity" concepts. Advanced LUT consist of a combination of elements, scored according to their suitability to provide recreation opportunities. In this application the scores for each input were generated from either the literature or expert input (Schröter et al., 2015). The final outcomes are based on cross tabulation and spatial composition derived from the overlay of different thematic maps (Zulian et al., 2017).

Figure 5-16 shows an example of ROS map, applied to the FUA of Padova (Italy).

Figure 5-17 shows the share of areas with high recreation potential within European FUAs.

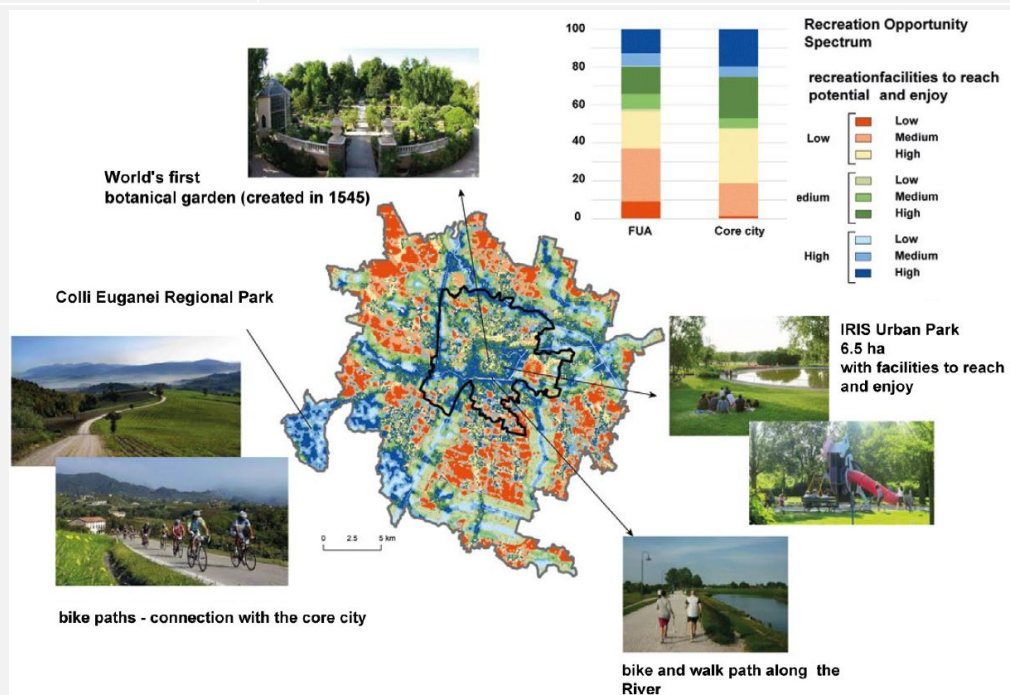

Figure 5-15. The approach for mapping recreation opportunities in cities explained for the functional urban area of Padova, Italy (source: Maes et al., 2019, Box 2).

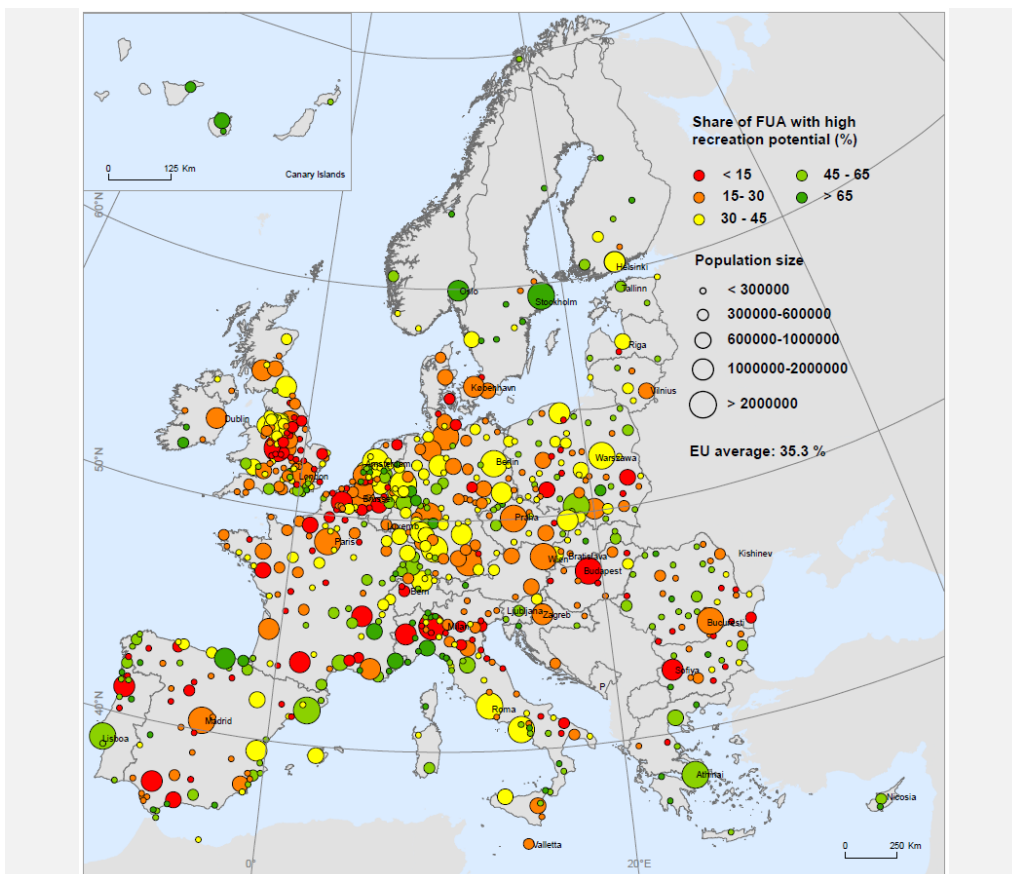

Figure 5-16. Surface area with high recreation potential in European functional urban areas (FUAs) (source: Maes et al., 2019).

<p>Stakeholders involved</p>	<p>EnRoute is a project of the European Commission in the framework of the EU Biodiversity Strategy and the Green Infrastructure Strategy. EnRoute provides scientific knowledge of how urban ecosystems can support urban planning at different stages of policy and for various spatial scales and how to help policy-making for sustainable cities. A key pillar of the project is science-policy interface. Local stakeholders were involved in all the activities carried on at a local scale.</p>
<p>Barriers encountered and lessons learned</p>	<p>Main barriers are linked to: expertise requested for the implementation of the indicator.</p>
<p>Case study author</p>	<p>Grazia Zulian¹, Georgia Kakoulaki² ¹JRC D3 Land Resources ²JRC C2</p>
<p>References</p>	<p>Cortinovis, C., Zulian, G., and Geneletti, D., 'Assessing Nature-Based Recreation to Support Urban Green Infrastructure Planning in Trento (Italy)', <i>Land</i>, Vol. 7, No 4, 2018, p. 112. Liquete, C., Piroddi, C., Macías, D., Druon, J.N., and Zulian, G., 'Ecosystem services sustainability in the Mediterranean Sea: Assessment of status and trends using multiple modelling approaches', <i>Scientific Reports</i>, Vol. 6, 2016, Art. No 34162.</p>

- Maes J., Zulian G., Günther S., Thijssen M., and Raynal J., 'Enhancing Resilience Of Urban Ecosystems through Green Infrastructure. Final Report', *Publications Office of the European Union*, Luxembourg, 2019.
- Paracchini, M.L., Zulian, G., Kopperoinen, L., Maes, J., Schägner, J.P., Termansen, M., Zandersen, M., Perez-Soba, M., Scholefield, P.A. and Bidoglio, G., 'Mapping cultural ecosystem services: A framework to assess the potential for outdoor recreation across the EU', *Ecological Indicators*, Vol. 45, 2014, pp. 371–385.
- Schröter, M., Remme, R.P., Sumarga, E., Barton, D.N. and Hein, L., 'Lessons learned for spatial modelling of ecosystem services in support of ecosystem accounting', *Ecosystem Services*, Vol. 13, 2015, pp. 64–69.
- Vallecillo, S., La Notte, A., Zulian, G., Ferrini, S., and Maes, J., 'Ecosystem services accounts: Valuing the actual flow of nature-based recreation from ecosystems to people', *Ecological Modelling*, Vol. 392, 2019, pp. 196–211.
- Zulian, G., Paracchini, M.L., Maes, J., and Liqueste, C., 'ESTIMAP: Ecosystem services mapping at European scale', *Publications Office of the European Union*, Luxembourg, 2013.
- Zulian, G., Stange, E., Woods, H., Carvalho, L., Dick, J., Andrews, C., Baró, F., Vizciano, P., Barton, D.N., Nowel, M., Rusch, G.M., Aurunes, P., Fernandes, J., Ferraz, D., Ferreira dos Santos, R., Aszalós, R., Arany, I., Czúcz, B., Priess, J.A., Hoyer, C., Bürger-Patricio, G., Lapola, D., Mederly, P., Halabuk, A., Bezak, P., Kopperionen, L., and Viinikka, A., 'Practical application of spatial ecosystem service models to aid decision support', *Ecosystem Services*, Vol. 29 C, 2018, pp. 465-480.

5.2.6 Green Space Management – Land composition

<p>NBS name and location</p>	<p>This indicator is part of a framework applied at European level to map and assess urban ecosystems condition and ecosystem services</p>
<p>Brief description of NBS</p>	<p>The indicator was implemented to assess Land composition in 700 European Functional Urban Areas (FUAs; see Figure 5-11 in case study 5.2.4 Green Space Management – Annual Trend in vegetation cover).</p> <p>This work was part of the EnRoute project and the MAES initiative. https://oppla.eu/groups/enroute https://publications.jrc.ec.europa.eu/repository/handle/JRC115375</p> <p>Mapping and Assessment of Ecosystems and their Services – MAES: https://ec.europa.eu/environment/nature/knowledge/ecosystem_assessment/index_en.htm</p>
<p>Additional Indicators of relevance</p>	<p>At European level the following indicators have been implemented:</p> <ul style="list-style-type: none"> 7.1 Green spaces Accessibility 7.2 Share of green urban areas 8.1 Ecosystem services provision (flood control, nature-based recreation, pollination) 8.2 Annual trend in vegetation cover in urban green infrastructure 8.31.1 ESTIMAP nature-based recreation 8.38 Land composition 8.39 Land use change and green space configuration 8.40 Soil sealing
<p>Explanation for selection of Additional Indicators</p>	<p>Land composition is a measure of the spatial distribution of elements or components of a landscape. It is used to consider the co-occurrence of land types within each FUA. It represents the arrangements of ecosystem types within and around cities (Figure 5-17).</p> <p>To quantify land composition we use the Landscape Mosaic (LM), model available in Guidos tool box https://forest.jrc.ec.europa.eu/en/activities/lpa/gtb/ (Vogt and Riitters, 2017).</p> <p>This indicator is useful to describe the context where NBS are deployed.</p>

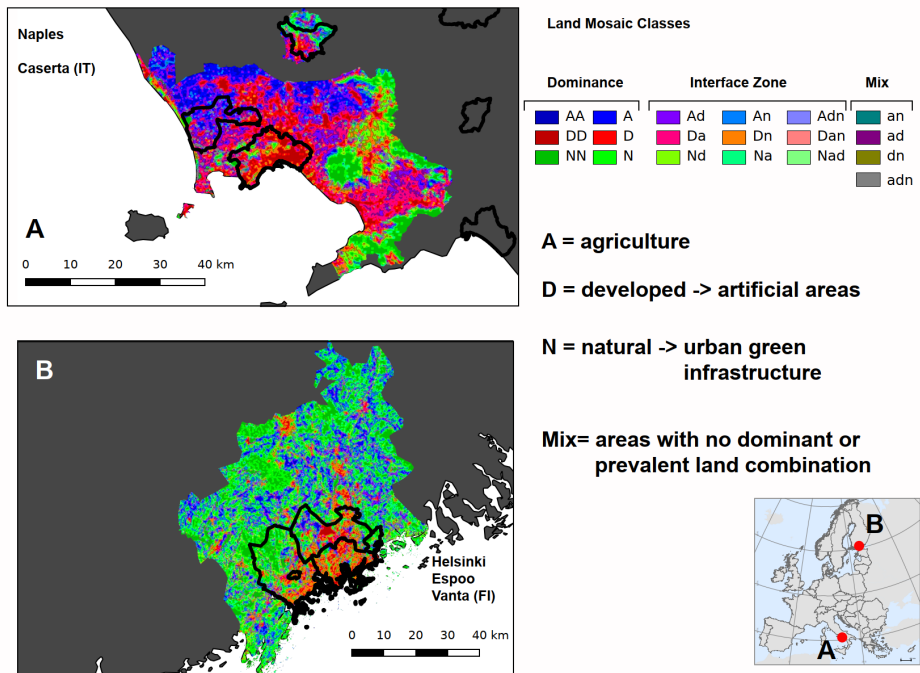

Figure 5-17. Land Mosaic maps in Helsinki (FI) and Naples (IT). A = Agriculture; D = Developed; N = natural; Mix = mixed presence of all land classes (source: Maes et al., 2019).

Description of Additional Indicator Application

Spatially explicit data are available for the 700 FUA.

In **EnRoute** the indicator was applied to explore the capacity of urban ecosystems to provide Ecosystem services city types based on land composition and population density. Urban Atlas (<https://land.copernicus.eu/local/urban-atlas>) was used as land cover dataset.

Figure 5-18. shows EU FUA classified with reference to land composition, population density and size.

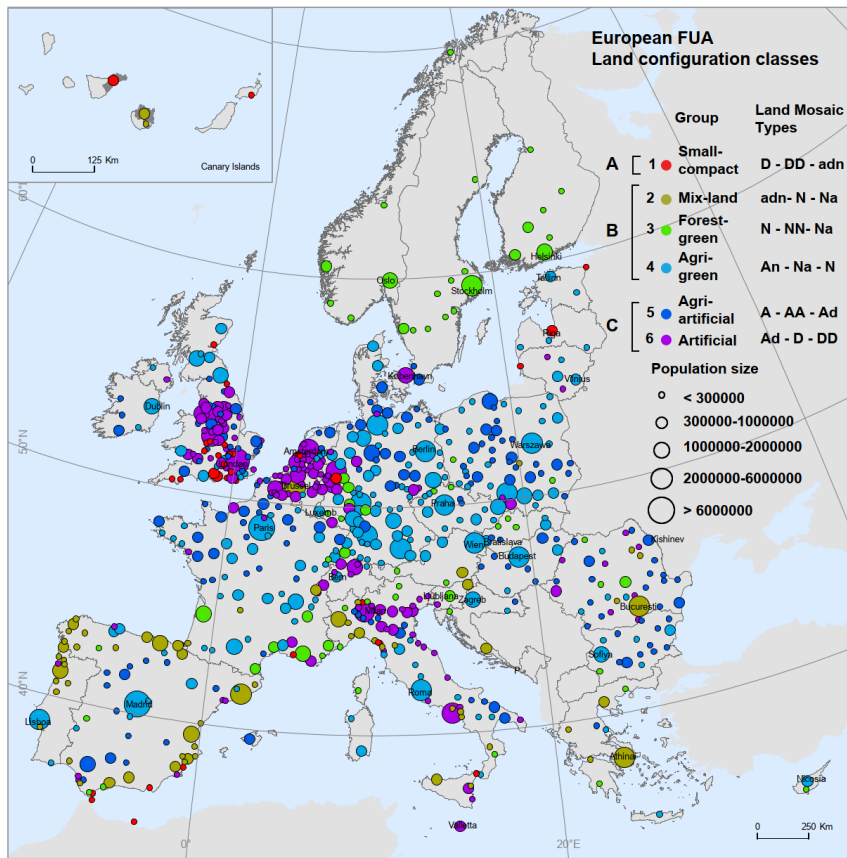

Figure 5-18. Spatial distribution of European functional urban areas (FUAs) classified by land composition, size and population density. The map includes FUAs in Norway and Switzerland (source: Maes et al., 2019).

Figure 5-19 shows the behaviour of two indicators (8.31.1 ESTIMAP nature based recreation and 7.2 share of urban green) with respect to the typology of cities. The indicators exhibit a high variability in average per city type as well as a high variability in the range of values. This is especially evident for the share of green spaces in core cities.

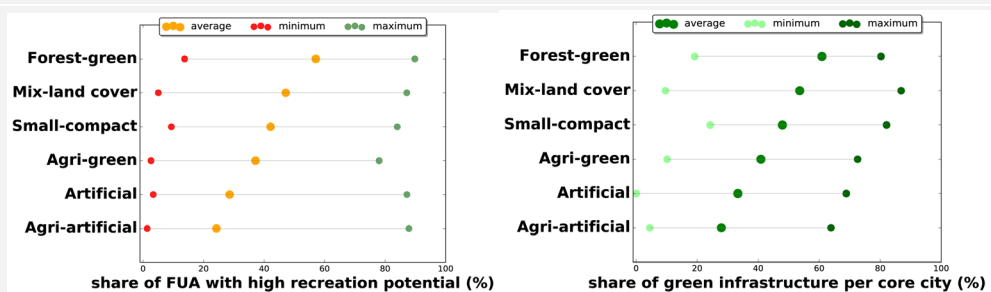

Figure 5-19. Average and range of the share of FUA with high recreation potential and share of green spaces per core city (source: Maes et al., 2019).

In **MAES** the indicator was applied to analyse the changes in land composition (Figure 5-20). Corine land Cover (<https://land.copernicus.eu/pan-european/corine-land-cover>) was used as land cover dataset.

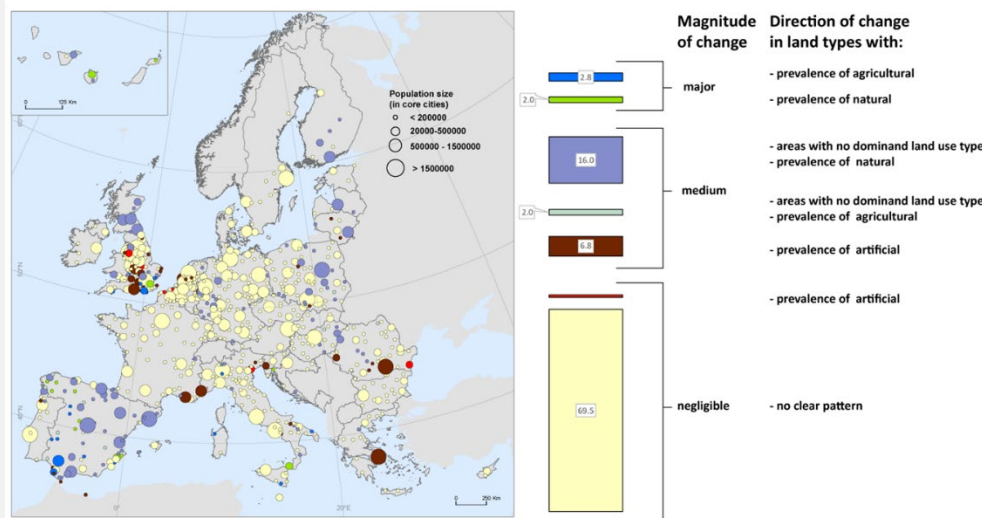

Figure 5-20. FUAs classified in terms of magnitude and direction of change between 2000 and 2018. (source: Maes et al., 2020, Chapter 3.1: Urban Ecosystems; Factsheet 3.1.107).

Stakeholders involved

EnRoute is a project of the European Commission in the framework of the EU Biodiversity Strategy and the Green Infrastructure Strategy. EnRoute provides scientific knowledge of how urban ecosystems can support urban planning at different stages of policy and for various spatial scales and how to help policy-making for sustainable cities. A key pillar of the project is science-policy interface. Local stakeholders were involved in all the activities carried on at a local scale.

MAES represents the core activity of Action 5 – Target 2 of the EU Biodiversity strategy to 2020. The all process, started in 2013 involved EU Member States, The Commission (DG ENV, DG-JRC), The European Environmental Agency (EEA) and several other stakeholders.

Specifically, a workshop, held in Brussels in June 2019 provided the opportunity for stakeholders to engage in the first EU wide ecosystem assessment.

Barriers encountered and lessons learned

Main barriers are linked to: expertise requested for the implementation of the indicators.

Case study author

Grazia Zulian (grazia.zulian@ec.europa.eu)
JRC D3 Land Resources

References

Maes, J., Zulian, G., Günther, S., Thijssen, M., and Raynal, J., 'Enhancing Resilience Of Urban Ecosystems through Green Infrastructure. Final Report', *Publications Office of the European Union*, Luxembourg, 2019.

Maes, J., Teller, A., Erhard, M., Condé, S., Vallecillo, S., Barredo, J.I., Paracchini, M.L., Abdul Malak, D., Trombetti, M., Vigiak, O., Zulian, G., Addamo, A.M., Grizzetti, B., Somma, F., Hagyo, A., Vogt, P., Polce, C., Jones, A., Marin, A.I., Ivits, E., Mauri, A., Rega, C., Czúcz, B., Ceccherini, G., Pisoni, E., Ceglar, A., De Palma, P., Cerrani, I., Meroni, M., Caudullo,

G., Lugato, E., Vogt, J.V., Spinoni, J., Cammalleri, C., Bastrup-Birk, A., San Miguel, J., San Román, S., Kristensen, P., Christiansen, T., Zal, N., de Roo, A., Cardoso, A.C., Pistocchi, A., Del Barrio Alvarelos, I., Tsiamis, K., Gervasini, E., Deriu, I., La Notte, A., Abad Viñas, R., Vizzarri, M., Camia, A., Robert, N., Kakoulaki, G., Garcia Bendito, E., Panagos, P., Ballabio, C., Scarpa, S., Montanarella, L., Orgiazzi, A., Fernandez Ugalde, O., and Santos-Martín, F., 'Mapping and Assessment of Ecosystems and their Services: An EU ecosystem assessment', EUR 30161 EN, Publications Office of the European Union, Ispra, 2020.

Vogt, P. and Riitters, K., 'GuidosToolbox: universal digital image object analysis', *European Journal of Remote Sensing*, Vol. 50, No 1, 2017, pp. 352–361.

5.2.7 Biodiversity Enhancement – Number of conservation priority species

NBS Name and Location	Growchapel and Bellahouston Open Spaces sites Glasgow, UK
Brief description of NBS	<p>As part of Glasgow City Council’s Open Space Strategy, they are rolling out a programme of nature-based solutions to provide targeted multifunctionality to underused open spaces across the city. The programme empowers NGOs and community groups to utilise local spaces and deliver permanent and meanwhile uses on them including the development of nature-based solutions. Interventions comprise anything from art installations, to pocket parks and urban grow-your-own spaces (Figure 5-21). Multifunctionality is at the heart of the design and Connecting Nature is supporting the out-scaling of the programme through greater focus on a nature-based solution approach, more support for NGOs and community groups to deliver sustainable stewardship plans, and a spatial dataset of ecosystem service needs across the city to support decision-making in relation to the design of the underused spaces.</p> <p>https://connectingnature.eu/glasgow https://connectingnature.eu/oppla-case-study/19384</p>
Additional Indicators of relevance	<p>10.16 Number of conservation priority species 7.1 Greenspace accessibility 9.1 Greenspace connectivity</p>
Explanation for selection of Additional Indicators	<p>Whilst biodiversity net-gain is a target of Glasgow City Council’s Open Space Strategy, these projects are typically delivered in small spaces and do not have the budgets to cover comprehensive biodiversity evaluations (e.g., Recommended biodiversity indicators like species diversity and functional connectivity). As such, a more targeted biodiversity indicator was needed. Evaluation of priority species associated with the spaces was seen as a win-win for the council as, it represented a more focused evaluation methodology, and it aligned more closely with strategic objectives of the local authority and existing monitoring programmes.</p>

Description of Additional Indicator Application	Before and after priority species evaluation would be carried out to assess any impact of the implemented nature-based solution. This would comprise a combination of local record searches and direct site evaluation.
Stakeholders involved	This evaluation would be carried out in collaboration with other monitoring schemes in the city (e.g., RSPB sparrow monitoring) and with other departments in within the council (e.g., biodiversity team).
Barriers encountered and lessons learned	Establishing contacts with appropriate departments and organisations was a challenge. Also identifying necessary expertise to carry out surveys.
Case study author	Stuart Connop (s.p.connop@uel.ac.uk) <i>University of East London, UK</i>
References	Connecting Nature Environmental Indicators review: https://connectingnature.eu/nature-based-solution-evaluation-indicators-environmental-indicators-review



Figure 5-21. Glasgow meanwhile space conversion providing a temporary grow-your-own space for the local community (© Glasgow City Council).

5.2.8 Air Quality – Trends in NO_x and SO_x emissions

<p>NBS name and location</p>	<p>Urban garden biofilter for air pollution Underground car park in Portugalete Square Plaza de la Libertad, 5, 47002 Valladolid (Spain)</p>
<p>Brief description of NBS</p>	<p>Urban Garden Biofilter is an air filter framed in an urban garden for the emissions of underground car parks or other stationary sources of pollutant compounds in urban environments. This NBS has been firstly prototyped for URBAN GreenUP Project (GA nº 730426).</p> <p>The NBS is composed of three main elements, the extractor system to extract the polluted air from underground car park, the plenum section to distribute the air under the Biofilter and the Biofilter itself to clean the air and metabolize pollutants (Figure 5-22).</p> <p>It is composed by several layers for support, pollutants absorption and protection and finally is cover by vegetation. The absorption/capture of air pollutants is made by the different layers and the metabolisation of these pollutants is made by the soil microbiota and the vegetation.</p> <p>This NBS has been developed by CARTIF in a previous research project. Project results show that it can be captured most of NO_x and PM (>90%) from indoor air (pollutants concentration 0.5-1 ppm).</p> <p>This NBS can be adapted to existing car parks or tunnels or included in the design of new infrastructures. It can be created a new line for indoor air extraction and conduct it to the plenum zone. Then, the air will be cleaned by passing through the biofilter materials. Due to the specific design of the biofilter layers, pressure drop of the filter is very low and simple extractor fan is used.</p>

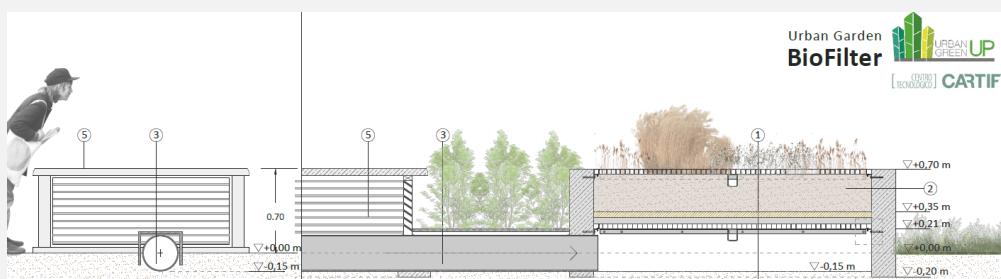

Figure 5-22. URBAN GreenUP Project: Biofilter cross section (© CARTIF).

<p>Additional Indicators of relevance</p>	<p>6.9 Trends in emissions NO_x and SO_x</p>
--	--

	<p>6.10 Monetary values: value of air pollution reduction; total monetary value of urban forests including air quality, run-off mitigation, energy savings, and increase in property values.</p> <p>6.11 Air quality parameters. NO_x and PM.</p> <p>6.13 Concentration of particulate matter (PM_{2.5} and PM₁₀) at respiration height along roadways and streets.</p>
Explanation for selection of Additional Indicators	<p>In future, if this NBS is widely installed it can be used recommended indicators for Air Quality challenge. Recommended indicators have a scale of measurement from district to region and they have not sensibility enough to study the impact of this NBS. Therefore, in the meantime it is needed additional indicators to assess the impact on air pollutants emission reduction with indicators such as the ones mentioned before.</p>
Description of Additional Indicator Application	<p>In this case, the main indicator for impact assessment is 6.11 and additionally the other ones. 6.11 implies the installation of three equipment for continuous monitoring of NO₂, O₃ and PM (inside of the car park, next to the biofilter and separated from the biofilter but in the same square or street).</p> <p>This indicator is completed with the other in order to value and compare biofilter impact with other NBS such as tree or bush lines.</p>
Stakeholders involved	<p>Different municipality areas (at least urbanism, environment and heritage), car park property, construction companies</p>
Barriers encountered and lessons learned	<p>The main difficult aspect is found in the design and project phase for the implementation of this NBS. Impact assessment can be carried out by using one or several of the indicators depending on the budget or monitoring tool available.</p> <p>Indicator 6.11 is highly recommended and monitoring locations should be done by experts for the first studies because this is an innovative solution. The implementation of this NBS is still ongoing so no experience has been collected from the monitoring. However, when ongoing pilot studies and field analysis finish, the assessment framework can be made simpler by using indicators such as 6.9 or 6.13.</p>
Case study authors	<p>Raúl Sánchez¹, Jose Feroso¹, Francisco Verdugo¹, Raquel Marijuan¹, Silvia Gómez, María González¹, José María Sanz¹, Esther San José¹, Alicia Villazán², Isabel Sánchez², Elena Sánchez², Natividad Sanz³, José Antonio Pérez⁴, Laura Crespo⁵</p> <p>¹CARTIF Foundation. P.T. Boecillo, 205, 47151, Boecillo, Valladolid, Spain</p> <p>²VALLADOLID City Council. Plaza Mayor 1, 47001, Valladolid, Spain</p> <p>³ISOLUX CORSAN aparcamientos. Plaza Portugalete, s/n, 47002 Valladolid, Spain.</p> <p>⁴CONYTRAIR. Ctra. Cabezón, 6, 47155 Santovenia de Pisuerga, Valladolid.</p> <p>⁵LAURA CRESPO ARCHITECT, Valladolid, Spain</p>

5.2.9 Knowledge and Social Capacity Building for Sustainable Urban Transformation – Connectedness to nature

NBS Name and Location	Living Lab districts In the cities of Turin (Italy), Zagreb (Croatia) and Dortmund (Germany)
Brief description of NBS	During the proGIreg project (https://progireg.eu/), this indicator will be assessed on the general population in the Living (LL) district and 300 in a different, comparable city district (“control district”) in each European Front-Runner City (FRC).
Additional Indicators of relevance	16.3 Mindfulness/ Connectedness to nature 22.13 Perceived restorativeness of NBS/ green space
Explanation for selection of Additional Indicators	This indicator is widely used in social sciences since it provides a reliable assessment of the relationship between human being and the natural environment
Description of Additional Indicator Application	Connectedness with nature is defined as the sense of oneness to nature. This indicator is part of the socio-cultural inclusiveness evaluation as a component of a survey for the assessment health, social and economic benefits of NBSs. The “Connectedness to nature scale” (CNS; Mayer, 2004), a validated tool for assessing this indicator, will involve 300 persons in each district during two time points, i.e., pre- and post- NBS implementations (after three years). The scale includes 14 items with a 5-point Likert scale ranging from “Strongly disagree” to “Strongly agree”.
Stakeholders involved	Civil local authorities and university students for data collection during baseline have been involved
Barriers encountered and lessons learned	<p>The three European FRCs followed a standardized procedure for recruitment and data collection, in accordance with the proGIreg scientific WP. Despite the support of the scientific WP through informal exchange of information and formal meetings in order to implement strategies to reach the target number of completed questionnaires, the final outcome differed within the FRCs. The city of Dortmund has collected 140 interviews (48 in the LL and 92 in the control district), the city of Turin has collected 398 interviews (221 in the LL and 177 in the control district). Only the city of Zagreb managed to reach and even exceeded the determined target number of interviews, previously set at 600 (302 from the LL and 313 from the control district).</p> <p>All cities sent a first information letter to the population in order to invite to participate in our research. In Turin, the invitation letters were sent a second time. As expected, the response rate was very variable between cities and was between 15% and 40%. The information reported by the cities provides useful insights for future planning of questionnaires, of which Connectedness with</p>

	<p>nature scale is part. Participants from each FRC complained about some aspects of the general questionnaire such as the excessive length and the presence of uncomfortable questions. No complaints were specifically addressed to the Connectedness with nature scale.</p> <p>Lessons learned regards the strategies that each FRC implemented to overcome the barriers encountered in reaching the target number of participants, briefly summarized below.</p> <ul style="list-style-type: none"> - Application of a door-to-door technique to directly approach the target population - Organization of public events in the neighbourhoods concerned in order to increase the sample size. - Second sending of invitation letters following the unsatisfactory response of the population to the first sending. - Possibility of hiring specialized personnel to conduct the survey.
Case study author	Giuseppina Spano (giuseppina.spano@uniba.it) <i>University of Bari, Italy</i>
References	Mayer, F., 'The connectedness to nature scale: A measure of individuals' feeling in community with nature', <i>Journal of Environmental Psychology</i> , Vol. 24, 2004, pp. 503-515.

5.2.10 Social Justice and Social Cohesion – Perceived social support

NBS Name and Location	Living Lab districts In the cities of Turin (Italy), Zagreb (Croatia) and Dortmund (Germany)
Brief description of NBS	During the proGIreg project (https://progireg.eu/), this indicator will be assessed on the general population in the Living (LL) district and 300 in a different, comparable city district ("control district") in each European Front-Runner City (FRC).
Additional Indicators of relevance	20.4.1 Perception of socially supportive network 20.4.2 Perceived social support
Explanation for selection of Additional Indicators	Empirical evidences showed that supportive social groups and effective and helpful social networks are associated with a good mental and physical health. This indicator is measured in the neighbour-hood context since a perception of high social support fosters social inclusion and justice.

Description of Additional Indicator Application	Perceived social support is defined as the perception of various ways in which individuals aid others. This indicator is obtained using an 8-point scale on general social support and a 6-point scale on social support in the neighbourhood.
Stakeholders involved	Civil local authorities and university students for data collection during baseline have been involved
Barriers encountered and lessons learned	<p>The three European FRCs followed a standardized procedure for recruitment and data collection, in accordance with the proGireg scientific WP. Despite the support of the scientific WP through informal exchange of information and formal meetings in order to implement strategies to reach the target number of completed questionnaires, the final outcome differed within the FRCs. The city of Dortmund has collected 140 interviews (48 in the LL and 92 in the control district), the city of Turin has collected 398 interviews (221 in the LL and 177 in the control district). Only the city of Zagreb managed to reach and even exceeded the determined target number of interviews, previously set at 600 (302 from the LL and 313 from the control district).</p> <p>All cities sent a first information letter to the population in order to invite to participate in our research. In Turin, the invitation letters were sent a second time. As expected, the response rate was very variable between cities and was between 15% and 40%. The information reported by the cities provides useful insights for future planning of questionnaires, of which the scale on perceived social support is part. Participants from each FRC complained about some aspects of the general questionnaire such as the excessive length and the presence of uncomfortable questions. No complaints were specifically addressed to the perceived social support scale.</p> <p>Lessons learned regards the strategies that each FRC implemented to overcome the barriers encountered in reaching the target number of participants, briefly summarized below.</p> <ul style="list-style-type: none"> - Application of a door-to-door technique to directly approach the target population - Organization of public events in the neighbourhoods concerned in order to increase the sample size. - Second sending of invitation letters following the unsatisfactory response of the population to the first sending. - Possibility of hiring specialized personnel to conduct the survey.
Case study author	Giuseppina Spano (giuseppina.spano@uniba.it) <i>University of Bari, Italy</i>
References	Pearson, J.E., 'The definition and measurement of social support', <i>Journal of Counseling and Development</i> , Vol. 64, 1986, p. 390-395.

5.2.11 Health and Wellbeing – Prevalence, incidence, and morbidity of chronic stress

NBS Name and Location	Stalled Spaces Glasgow, Scotland
<p>Brief description of NBS</p>	<p>Description</p> <p>Stalled Spaces (Figure 5-23) is a programme launched by Glasgow City Council to support community groups and local organisations across the city develop temporary projects on stalled sites or under-utilised open spaces. In particular, the Stalled Spaces programme gives local organizations the opportunity to temporarily use a plot of these spaces in a way which will bring multiple benefits to the local communities.</p> <p>Projects supported by the programme deliver a range of initiatives based on the needs of the community. It means that community stakeholders decide how to use these spaces and how to adapt them to cover their needs. Examples of these initiatives are: growing spaces, pop-up gardens, wildlife areas, urban gyms or natural play spaces, temporary art in the form of pop-up sculptures, and spaces for events or exhibitions.</p> <p>Relevance</p> <p>The programme was started in 2011 and only in its first five years has helped deliver over 100 projects that have successfully brought over 25 ha of vacant, underutilised or stalled sites under temporary community use.</p>
<p>Additional Indicators of relevance</p>	<p>22.22 Prevalence, incidence, morbidity of chronic stress</p> <p>Short name: Chronic stress</p> <p>Definition: Within Connecting Nature, stress is defined as the process by which an individual responds psychologically, physiologically, and often with behaviours, to a situation that challenges or threatens well-being (Baum et al., 1985 as cited in Ulrich et al., 1991, p. 202). The psychological component includes cognitive appraisal of the situation, emotions such as fear, anger, and sadness, and coping responses (Ulrich et al., 1991).</p>
<p>Explanation for selection of Additional Indicators</p>	<ol style="list-style-type: none"> Theoretical pertinence. Two theoretical frameworks that establish an association between exposition to / engagement with nature and stress alleviation have been identified: Attention Restoration Theory (ART) (Kaplan, 1995) and Stress Recovery Theory (SRT) (Ulrich et al., 1991). Impact of the health problem. Chronic stress associated to modern urban lifestyles is a serious health problem with an increasing incidence around the world. Moreover, psychological stress is considered as a significant factor in the onset, course and exacerbation of other chronic diseases (depression, cardiovascular diseases...) and it has been related to the higher overall mortality (Cohen et al., 2007; Hammen, 2005; Klein et al., 2016).

	<p>3. Appropriateness of the NBS characteristics. The multiple initiatives launched in the frame of the Stalled Spaces Programme over the last decade have not only contributed to regenerate some areas in Glasgow, but also to revitalize local communities, to reconnect people with nature, to generate opportunities for social interaction, to stimulate social cohesion or to support physical activity. Each of these achievements constitutes mechanisms to alleviate chronic stress associated to urban lifestyle and needs to be explored further to understand how they work and how they could be reinforced to become more effective.</p> <p>4. Indicator strengths. Chronic stress is considered as a reliable indicator to assess physical and mental health and general wellbeing. In addition, it is appropriate to explore whether the exposition to a NBS contributes to mitigate stress.</p>
<p>Description of Additional Indicator Application</p>	<p>The tool selected and applied by Glasgow to measure the chronic stress indicator in the Stalled Spaces programme is the 10-items Perceived Stress Scale (Cohen et al., 1983) included in a survey with other indicators specifically chosen to assess the multiple benefits associated to the implementation of this programme. This scale is a self-report measure that provides psychological subjective data. In particular, it intends to capture the degree to which persons perceive situations in their daily life as excessively stressful in relation to their ability to cope with them.</p> <p>Methodology and data analysis require high expertise in psycho-social research but quantitative data collection does not require expertise.</p>
<p>Stakeholders involved</p>	<p>Glasgow City Council; Connecting Nature partners; Data collection experts (responsible for collecting subjective psychological data)</p>
<p>Barriers encountered and lessons learned</p>	<p>Barriers encountered</p> <p>Given the complex psychophysiological pathways of stress, measurement is usually approached holistically through collection of both subjective psychological (i.e., subjective rating scales, self-report measures) and objective physiological data (most frequently, salivary analysis due to the validity, reliability and ease of collection of salivary data). However, collecting biochemical data for evaluating a NBS is considered as a major challenge by the majority of cities for two main reasons: (i) data collection and analysis of biochemical samples require high clinical expertise, resources and capacities which are frequently difficult to acquire for cities; (ii) barriers usually encountered during fieldwork planning -and in particular those related to the recruitment of participants - for any study increase when clinical procedures are included in the design. This means that this objective physiological measure is feasible in the experimental research usually conducted by academic and health organizations, but not in the frame of a routine evaluation conducted by cities.</p> <p>Lessons learned</p> <ol style="list-style-type: none"> 1. The experience of Glasgow has demonstrated that it is essential to provide a detailed description of the characteristics of the NBS under evaluation and, in particular, of the activities deployed in it (i.e., gardening, urban gyms,

	<p>play spaces...). The high diversity of uses allocated to the Stalled Spaces in Glasgow constitutes an unexceptional opportunity to identify which activities have a most positive impact in the stress alleviation (i.e., comparing activities that enhance physical activity with those that promote social interaction).</p> <ol style="list-style-type: none"> 2. In order to gain a holistic understanding of the NBS impact on the physical and mental health, it is also recommended to measure this indicator in combination with other indicators that could contribute to enrich data analysis and interpretation. In particular, it is suggested to also collect data about place attachment; general wellbeing and happiness; and depression and anxiety. 3. It is strongly recommended to collect data on symbolic / affective meanings assigned to NBS using participatory data collection methods and qualitative techniques. These data are useful to understand why and how the exposition to, and the engagement with, the NBS could contribute to alleviate chronic stress.
<p>Case study authors</p>	<p>Adina Dumitru¹ (adina.dumitru@udc.es), David Tomé-Lourido¹, Susana Pablo¹ ¹University of A Coruña, Spain</p>
<p>References</p>	<p>Cohen, S., Kamarck, T., and Mermelstein, R., 'A global measure of perceived stress', <i>Journal of Health and Social Behavior</i>, Vol. 24, No 4, 1983, pp. 385-396.</p> <p>Cohen, S., Janicki-Deverts, D., and Miller, G. E., 'Psychological stress and disease', <i>Journal of the American Medical Association</i>, Vol. 298, No 14, 2007, pp. 1685-1687.</p> <p>Glasgow City Council, <i>Open Space Strategy</i>, 2020.</p> <p>Hammen, C., 'Stress and Depression', <i>Annual Review of Clinical Psychology</i>, Vol. 1, 2005, pp. 293-319.</p> <p>Kaplan, S., 'The Restorative Benefits of Nature: Toward an Integrative Framework', <i>Journal of Environmental Psychology</i>, Vol. 15, 1995, pp. 169-182.</p> <p>Klein, E.M., Brähler, E., Dreier, M., Reinecke, L., Müller, K.W., Schmutzer, G.G., Wöfling, K., and Beutel, M.E., 'The German version of the Perceived Stress Scale – psychometric characteristics in a representative German community sample', <i>BMC Psychiatry</i>, Vol. 16, 2016, pp. 1-10.</p> <p>Ulrich, R.S., Simons, R.F., Losito, B.D., Fiorito, E., Miles, M.A., and Zelson, M., 'Stress recovery during exposure to natural and urban environments', <i>Journal of Environmental Psychology</i>, Vol. 11, No 3, 1991, pp. 201-230.</p> <p>White, J.T. and Bunn, C., 'Growing in Glasgow: Innovative practices and emerging policy pathways for urban agriculture', <i>Land Use Policy</i>, Vol. 68, 2017, pp. 334-344.</p>



Figure 5-23. Stalled Spaces Programme (© Glasgow City Council).

5.2.12 Health and Wellbeing – Perceived chronic loneliness

NBS Name and Location	Bellahouston Demonstration Garden Glasgow, Scotland
Brief description of NBS	<p>Bellahouston Demonstration Garden was established in the city of Glasgow, providing allotment-style growing spaces to be used by different charities and educational establishments (Hölscher et al., 2019; White and Bunn, 2017). The NBS arises from the Allotment and Neighbourhood and Sustainability strategies, carried out by the Glasgow City Council, highlighting the restorative and therapeutic benefits of gardening, due to social interaction in the community (White and Bunn, 2017).</p> <p>The objective of this growing space located in the walled Garden at Bellahouston Park is twofold, on the one hand to provide healthy and sustainable food to the neighbours, and on the other hand to create a community space with social and health benefits for the citizens of Glasgow.</p>
Additional Indicators of relevance	<p>22.9 Perceived chronic loneliness</p> <p>Within Connecting Nature, this indicator is conceptualized as a subjective experience of being socially isolated and absent both relational and collective connectedness (Russell et al., 1980).</p>

<p>Explanation for selection of Additional Indicators</p>	<p>The strategies implemented for the creation of demonstration gardens and growing spaces in Glasgow seek to promote social interaction and engaging people who felt isolated from the community (White and Bunn, 2017). Social isolation has a lasting impact on health and wellbeing (e.g., increased levels of stress, depression, or cardiovascular concerns) (Holt-Lunstad et al., 2010; Holt-Lunstad et al., 2015; Pantell et al., 2013), while social cohesion and green space are associated with positive outcomes like reduced smoking, alcohol consumption, obesity, or cognitive decline (Jennings and Bamkole, 2019; Wendelboe-Nelson et al., 2019).</p> <p>Green spaces contribute to social cohesion through fostering positive social interactions and social engagement (Jennings and Bamkole, 2019). Natural features also enhance feelings of place attachment and identity, promoting a sense of community that contributes to a decrease in feelings of loneliness (Prezza et al., 2001). A lower presence of green spaces in people's living environment was found to be related to greater feelings of loneliness and perceived shortage of social support (Maas et al., 2009). The association between green spaces, perceived social support and loneliness was found to be the strongest in highly urbanized areas (Maas et al., 2009).</p> <p>These research results, as well as the existing reality in the city led the Connecting Nature team to consider Chronic loneliness as a significant indicator to know the influence of the Bellahouston Demonstration Garden (Figure 5-24) on the well-being of its users.</p>
<p>Description of Additional Indicator Application</p>	<p>The indicator is assessed using a standardized quantitative instrument: The Three-Item Loneliness Scale (Hughes et al., 2004). This tool is a short form of the revised UCLA Loneliness scale (Russell et al., 1980) which measures the experience of loneliness. This scale includes three items measured on a 3-point Likert scale (1 = hardly ever; 2 = some of the time; 3 = often). For final scoring purposes, each person's scale responses to the three items are summed, with higher scores indicating greater experienced loneliness (Hughes et al., 2004).</p> <p>Methodology and data analysis require high expertise in psycho-social research but quantitative data collection requires no expertise. During the Connecting Nature project, the data gathering is conducted after the NBS implementation, but it allows making comparisons between different areas of the city or population groups (i.e., users vs no users). It is suggested to conduct two data collection waves to assess the longitudinal effects over time.</p>
<p>Stakeholders involved</p>	<p>Connecting Nature; Glasgow City Council; Glasgow Community Planning Partnership; Data collection experts</p>
<p>Barriers encountered and lessons learned</p>	<p>Although the officers leading the Food Growing Strategy were aware that the Bellahouston Demonstration Garden provided social, environmental, health and economic benefits, they had difficulties both in reflecting these advantages in official papers,</p>

	<p>and in holding conversations with the community and funding bodies (Hölscher et al., 2019).</p> <p>Therefore, within the Connecting Nature project a suitable business model was identified to scale up and replicate the project to other areas of the city (van de Sijpe et al. 2019). In this way, the Connecting Nature project provided the knowledge to develop food growing business within the Food Growing Strategy of the city council, conducting conversations with the community and identifying possible funding routes.</p>
<p>Case study authors</p>	<p>Adina Dumitru¹ (adina.dumitru@udc.es), David Tomé Lourido¹, Susana Pablo¹ ¹University of A Coruña, Spain</p>
<p>References</p>	<p>Hölscher, K., Lodder, M., Collier, M., Frantzeskaki, N., Sillen, D., Notermans, I., Allaert, K., Dumitru, A., Connop, S., Vandergert, P., McQuaid, S., Quartier, M., van de Sijpe, K., Vos, P., Dick, G., Kelly, S., Mowat, L., Sermepezi, R., Dziubala, A., Madajczyk, N., and Osipiuk, A., <i>Deliverable 5: Nature-based Solutions Framework for frontrunner cities</i>, 2019, CONNECTING Nature, Grant Agreement number 730222.</p> <p>Holt-Lunstad, J., Smith, T.B., and Layton, J.B., 'Social relationships and mortality risk: a meta-analytic review', <i>PLoS medicine</i>, Vol. 7, No 7, 2010, pp. 1-20.</p> <p>Holt-Lunstad, J., Smith, T.B., Baker, M., Harris, T., and Stephenson, D., 'Loneliness and social isolation as risk factors for mortality: a meta-analytic review', <i>Perspectives on Psychological Science</i>, Vol. 10, No 2, 2015, pp. 227-237.</p> <p>Hughes, M.E., Waite, L.J., Hawkey, L.C., and Cacioppo, J.T., 'A short scale for measuring loneliness in large surveys: Results from two population-based studies', <i>Research on Aging</i>, Vol. 26, No 6, 2004, pp. 655-672.</p> <p>Jennings, V. and Bamkole, O., 'The relationship between social cohesion and urban green space: An avenue for health promotion', <i>International Journal of Environmental Research and Public Health</i>, Vol. 16, No 3, 2019, pp. 452.</p> <p>Maas, J., Van Dillen, S.M., Verheij, R.A., and Groenewegen, P.P., 'Social contacts as a possible mechanism behind the relation between green space and health', <i>Health and Place</i>, Vol. 15, No 2, 2009, pp. 586-595.</p> <p>Pantell, M., Rehkopf, D., Jutte, D., Syme, S.L., Balmes, J., and Adler, N., 'Social isolation: a predictor of mortality comparable to traditional clinical risk factors', <i>American Journal of Public Health</i>, Vol. 103, No 11, 2013, pp. 2056-2062.</p> <p>Prezza, M., Amici, M., Roberti, T., and Tedeschi, G., 'Sense of community referred to the whole town: Its relations with neighboring, loneliness, life satisfaction, and area of residence', <i>Journal of Community Psychology</i>, Vol. 29, No 1, 2001, pp. 29-52.</p> <p>Russell, D., Peplau, L.A., and Cutrona, C.E., 'The revised UCLA Loneliness Scale: concurrent and discriminant validity evidence', <i>Journal of Personality and Social Psychology</i>, Vol. 39, No 3, 1980, pp. 472-480.</p> <p>van de Sijpe, K., Vos, P., Dick, G., Mowat, L., Dziubala, A., Zwierzchowska, I., Vandergert, P., Jelliman, S., Connop, S., Nash, C., and González, G., <i>Deliverable 9: An interim report on progress towards initiation of city-wide nature-based solutions exemplars</i>, 2019, CONNECTING Nature, Grant Agreement number 730222.</p> <p>Wendelboe-Nelson, C., Kelly, S., Kennedy, M., and Cherrie, J. W., 'A scoping review mapping research on green space and associated mental health benefits', <i>International Journal of Environmental Research and Public Health</i>, Vol. 16, No 12, 2019, 2081.</p> <p>White, J.T. and Bunn, C., 'Growing in Glasgow: Innovative practices and emerging policy pathways for urban agriculture', <i>Land Use Policy</i>, Vol. 68, 2017, pp. 334-344.</p>



Figure 5-24. Bellahouston Demonstration Garden (© Glasgow City Council).

5.3 Conclusions

The case studies herein illustrate the strength of the 'buffet' style approach of the NBS impact indicator framework presented in this handbook. The inherent heterogeneity of NBS – in type, form and scale of application – preclude a one-size-fits-all approach to NBS impact assessment. In this context, the Recommended indicators provide a suggested minimum suite of indicators in order to obtain a holistic assessment of NBS performance and impact, with the selection of specific Additional indicators serving to address specific concerns and thus augment the achieved understanding. The preceding case studies show how a combination of Recommended and Additional indicators may be applied to a specific NBS in order to develop a comprehensive understanding of NBS performance and impact, thereby enabling adaptive management of the NBS asset.

NAIAD

Nature Insurance value: Assessment and Demonstration

Thames basin (GB) Medina del Campo aquifer (ES) Lower Danube basin (RO)

Lez basin (FR) La Brague basin (FR) Glinscica catchment (SI)

Copenhagen (DK) Lodz (PO) Rotterdam (NL)

NAIAD is aimed to develop a strong conceptual framework for evaluating the assurance and the insurance value of ecosystem services. The project has developed the concept of natural assurance schemes, and the range of tools and methods to design them. These range from physical, social and economic assessments, integration and co-design with stakeholders, to the development of business models and financing arrangements to their full implementation and monitoring. Stakeholders involved included insurers, river basin agencies, local authorities, farmers in the validation and application in nine case study sites across Europe. It finally aims to contribute to academic knowledge and policy action on NBS planning and integration, and contribute to raise awareness on NBS and the associated socio-economic opportunities at all scales.

Drawing on knowledge from projects funded by the European Union

Approach to Impact Assessment

The NAIAD framework is designed for effectiveness assessment and decision-making with respect to the choice of best NBS measures and strategies. The different steps of disaster risk reduction and contributions of NBS are studied within the NAIAD project considering technical, physical but also social, human, environmental and economic features. A specific methodology is designed to determine the indicators. Relevant indicators are defined by experts and stakeholders through workshops. A two-level approach is proposed making a difference between technical analysis and decision-making contexts. Expert and technical assessments are used as inputs in a multicriteria decision-making framework which allows to address all kinds of technical, environmental, economic, or social features, and to consider stakeholder preferences as identified during participative workshops.

Involved Stakeholders and roles

A core operating principal of NAIAD is to proactively engage with stakeholders in the case studies throughout the application of its conceptual and assessment methodologies for Natural Assurance Schemes. The interdisciplinary nature of the whole approach fundamentally makes it relevant to a wide range of stakeholders, including decision makers, practitioners, scientists, end users and communities. Each stakeholder will have their own particular knowledge and perspectives of the integrated physical, social, cultural and economic systems in which the case study is situated, with all these needing to be shared and synthesised during the assessments. In addition, the stakeholders served an important function in terms of "road testing" and validating the tools and methods developed and presented in this volume.

Municipal Administrations

Regional/national statistics authority

Planning experts

Scientists / Academia

NGOs

River basin authorities

Insurance sector

Farmers

Main Challenges addressed

1. Climate Resilience

2. Water Management

3. Natural and Climate Hazards

4. Green Space Management

5. Biodiversity

6. Air Quality

7. Place Regeneration

8. Knowledge and Social Capacity Building

9. Participatory Planning and Governance

10. Social Justice and Social Cohesion

11. Health and Wellbeing

12. New Economic Opportunities & Green Jobs

Lessons learned

The first lesson learned on impact assessment from the NAIAD project is the importance of tailoring the approach to the catchment or pilot peculiarities. Providing an objective, easily understandable method to assess indicators of physical, social and economic effectiveness of NBS is essential to guarantee security but also to increase acceptance by stakeholders.

Different tools for impact assessment developed in NAIAD are tailored to the different demos allowed to get specific results for consensually agreed impact indicators, with high level of acceptance and satisfaction from stakeholders considering both technical, physical, environmental, economic, social and human effects and co-benefits of measures and strategies. One example is the Flood-Ex-cess-Volume (FEV) method that has been developed to quickly assess cost-efficacy of flood-mitigation strategies and proved useful in stakeholder workshops for raising public awareness of flood risk assessment before choosing a NBS strategy.

Learn more
www.naiad2020.eu



OPERANDUM

Open-air laboratories for Nature Based Solutions to manage hydro-meteo risks

OAL-Australia

OAL-Austria

OAL-ChinaMainLand

OAL-ChinaHongKong

OAL-Finland

OAL-Germany

OAL-Greece

OAL-Ireland

OAL-Italy

OAL-UK

OPERANDUM will deliver tools and methods for the demonstration and market uptake of Nature-Based Solutions to reduce hydro-meteorological risks. Nature-Based Solutions (NBS) are solutions that are inspired and supported by nature. These solutions provide environmental, social and economic benefits and help build resilience by bringing natural features into cities and landscapes. In the OPERANDUM project, site-specific and innovative NBS are co-designed, co-developed, deployed, tested and demonstrated with partners and local stakeholders in open-air laboratories. These open-air laboratories (OALs) are natural and rural Living Labs that cover a wide range of hazards with different climate projections, land use and socio-economic characteristics.

Drawing on knowledge from projects funded by the European Union

SCOPE To provide evidence, best practices, replication and scalability of existing and novel NBS, foster uptake of solutions to increase market exploitation

Approach to Impact Assessment

The project's approach is based on 10 Open-Air Laboratories: areas exposed to specific hydro-meteorological risks where the efficacy of existing and novel NBS are assessed at local scale. OALs provide concrete, flexible and transportable frameworks in order to expand the adoption of green/blue/hybrid infrastructures across Europe and in developing countries. The OALs in OPERANDUM demonstrate NBS for different climatic zones and different climate change scenarios in Europe. The implemented NBS build upon multi-disciplinary expertise and full understanding of the role of ICT and takes into account market exploitation and national, EU and international policies.

Involved Stakeholders and roles

Due to the complexity of the Project a multiple level structure of engagement strategy is required. Starting from the local community, the Project involves stakeholders at national and international level to leverage widest possible NBS acceptance to promote its diffusion as a good practice and push business exploitation. The stakeholder engagement strategy is based on the stakeholder mapping to identify the main target categories of OPERANDUM. An important step in the stakeholder engagement process is represented by the prioritizing of stakeholders: a Power-Interest Matrix has been adopted as a useful tool to assessing the level of engagement required of different stakeholder groups. Furthermore, for each stakeholders category, reasons of interest and expectations have been identified to obtain a greater understanding of stakeholders motivations, interests, needs, and requirements.

Municipal Administrations

Citizen

Planning experts

Scientists / Academia

Green businesses

Regional/national authority

National/regional park's authorities

International bodies

Policy makers

Main Challenges addressed

1. Climate Resilience

2. Water Management

3. Natural and Climate Hazards

4. Green Space Management

5. Biodiversity

6. Air Quality

7. Place Regeneration

8. Knowledge and Social Capacity Building

9. Participatory Planning and Governance

10. Social Justice and Social Cohesion

11. Health and Wellbeing

12. New Economic Opportunities & Green Jobs

Lessons learned

The challenges found across the OALs so far (OPERANDUM is still halfway) are related to the awareness, attitudes and trust, diversity of goals and interests, financial, legislative, resources (skills or time). We found that monitoring during the co-creation process and evaluation at the end of the process are important phases to facilitate the adoption of changes, improve the process, and enhance learning among partners. Defining common strategy for stakeholder engagement that includes tactics, formats, ethical rules and indicators for monitoring, is found to be of a paramount importance. The involvement of stakeholders has to be promoted in every step of the project and it's essential to maintain current communication or collaboration practices according to the needs of each phase. The novel platform, the OPERANDUM-GeoIKP has been designed ad-hoc to reach target users (stakeholders) including citizens, public authorities, policy makers. It is mandatory that information is conveyed using the up-to-date scientific evidence as well as worked examples.

Learn more
www.operandum-project.eu



The OPERANDUM project has received funding from the European Union's Horizon 2020 research and innovation programme under grant agreement No 776848.

PHUSICOS

Solutions to reduce risk in mountain landscapes

Gudbrandsdalen Valley (NO) The Pyrenees (ES/FR) Isar River Basin, Munich (DE)

Serchio River Basin / Massacciucoli Lake (IT) Kaunertal Valley (AT)

PHUSICOS, meaning 'According to nature', in Greek φυσικός, aims to demonstrate how nature-inspired solutions reduce the risk of extreme weather events in rural mountain landscapes. The focus of PHUSICOS is on demonstrating the effectiveness of NBS and their ability to reduce the impacts from hydro-meteorological hazards (flooding, landslide, erosion, drought, snow avalanche) in rural mountain landscapes. The NBS considered and implemented in PHUSICOS are cost-effective and sustainable measures inspired by nature that attenuate, and in some cases prevent, the impacts of natural hazard events and thereby the risks that affect the exposed regions.

**Drawing on knowledge from projects
funded by the European Union**

Image: Small landslide in Kvam, Norway - Photo © Ingar Håug Steinholt, NGI

Approach to Impact Assessment

The PHUSICOS NBS Impact Assessment Framework is based on a multicriteria decision analysis, which assesses, through a matrix containing indicators aggregated in different sub-criteria, the risk reduction performance and the co-benefits of a design scenario for a specific site. Indicators are selected after an extensive review of the main existing NBS project networks and platforms, as well as the challenges indicated by the EKLIPSE project. The five main categories (ambits) considered in the evaluation of an NBS in the PHUSICOS framework are 1) Risk reduction, 2) Technical and feasibility aspects, 3) Environment and ecosystems, 4) Society, and 5) Local Economy.

Involved Stakeholders and roles

Stakeholder involvement and participation is a key component in the successful design, planning and implementation of NBS. PHUSICOS uses a Living Labs approach to frame and carry out the participatory processes with stakeholders at the different case study sites. Rather than a single definition, PHUSICOS has emphasized focusing on Living Lab principles to ensure tailor-made processes for co-creating and co-developing NBSs including fostering innovation and learning, diversity, user-centered, locally relevant context, and open-mindedness. The PHUSICOS Living Labs also highlight the need to engage stakeholders from four main networks: public organizations, private companies, users (or end-users), and knowledge institutions (academia). These different groups of stakeholders are providing initial reflections and identifying indicators that are most relevant based on their knowledge and needs with regard to implementing and monitoring NBS.

Municipal Administrations

Regional/national statistics authorities

Citizen

Planning experts

Scientists / Academia

Main Challenges addressed

1. Climate Resilience

2. Water Management

3. Natural and Climate Hazards

4. Green Space Management

5. Biodiversity

6. Air Quality

7. Place Regeneration

8. Knowledge and Social Capacity Building

9. Participatory Planning and Governance

10. Social Justice and Social Cohesion

11. Health and Wellbeing

12. New Economic Opportunities & Green Jobs

Lessons learned

As part of the process of monitoring relevant indicators to assess the impact and efficacy of NBSs, stakeholders in the Living Labs have been engaged to provide input to the development of these monitoring systems. Thus far, reflections have been collected from the Serchio River Basin demonstrator case study site at Massacciuccoli Lake in Italy. In dialogue with local farmers, buffer strips to reduce the hydro-meteorological risk and improve the water quality are being implemented. Feedback on monitoring indicates that for each of the five main categories (ambits) in the PHUSICOS NBS evaluation framework, at least one of the proposed indicators is considered useful; with those focusing on implementation and maintenance costs as well as the policy context as the most valuable. Furthermore, publicly sharing monitoring results is viewed positively, also as a means of promoting NBS to the public.

Learn more
www.phusicos.eu



RECONNECT

Regenerating Ecosystems with Nature-based solutions for hydro-meteorological risk rEduCTion

Elbe Estuary (DE) Seden Strand Odense (DK) Todera River Basin (DK) Park Portofino (IT)

Ijssel River Basin (NL) Inn River Basin (AT) Greater Aarhus (DK) Thur River Basin (CH)

Var River Basin (FR) Les Boucholeurs (FR) Kamchia River Basin (BG) Pilica River Basin (PL)

Sava River Basin (RS/HR) Chao Praya River Basin (TH) Greater Tainan Coastline (TW)

Rio do Couves (BR) Klang River Basin (MY) Yangtze River Basin (CN) Chindwin River Basin (MM)

Tarago River Basin (AU) Trinity River Basin (US) Piura River Basin (PE) Rio Frio (CO)

Cañaveralejo, Lili and Melendez River Basins (CO) Coastline of St. Maarten (SX)

RECONNECT aims to rapidly enhance the European reference framework on Nature-Based Solutions (NBS) for hydro-meteorological risk reduction by demonstrating, referencing, upscaling and exploiting large-scale NBS in rural and natural areas. In an era of Europe's natural capital being under increased cumulative pressure, RECONNECT will stimulate a new culture of co-creation of 'land use planning' that links the reduction of hydro-meteorological risk with local and regional development objectives in a sustainable and financially viable way. To do that, RECONNECT draws upon a network of carefully selected Demonstrators and Collaborators that cover a wide and diverse range of local conditions, geographic characteristics, institutional/governance structures and social/cultural settings to successfully upscale NBS throughout Europe and Internationally.

Drawing on knowlegde from projects funded by the European Union

Approach to Impact Assessment

In RECONNECT, NBS Impact Assessment is carried out in relation to three categories of challenges i.e., WATER, NATURE and PEOPLE. Where possible, monitoring data is being, or will be, collected and transmitted through real-time SCADA/telemetry services and also through social science surveys. These data will be used to evaluate the NBS impacts in relation to benefits, co-benefits as well as the negative effects.

Monitoring and evaluation of NBS against the WATER challenges address questions related to hydro-meteorological risks. Monitoring and evaluation of NBS against the NATURE challenges address questions related to habitat structure and the biodiversity of flora and fauna. Monitoring and evaluation of NBS against the PEOPLE challenge address questions concerning social and economic benefits, with implications for human health and well-being and resilience to impacts from hydro-meteorological events.

Involved Stakeholders and roles

A co-monitoring and co-evaluation framework is being developed for Demonstrators A and B. There are two kinds of RECONNECT monitoring activities within this framework. The first one is monitoring to assess the state of the system (e.g. the general conditions in the NBS area), i.e., baseline monitoring before construction of NBS, and the second one is monitoring to assess the performance of implemented NBS towards the achievement of the project's goals/sub-goals.

Municipal Administrations (FR/FL)

Regional/national statistics authority

Citizen

Planning experts

Scientists / Academia

NGOs

Main Challenges addressed

1. Climate Resilience

2. Water Management

3. Natural and Climate Hazards

4. Green Space Management

5. Biodiversity

6. Air Quality

7. Place Regeneration

8. Knowledge and Social Capacity Building

9. Participatory Planning and Governance

10. Social Justice and Social Cohesion

11. Health and Wellbeing

12. New Economic Opportunities & Green Jobs

Lessons learned

There is some information available that can be used to evaluate the impact of NBS on hydro-meteorological risk reduction and biodiversity enhancement. However, there is still a lack of knowledge in terms of monitoring and impact evaluation for PEOPLE benefits (e.g., human health and well-being).

Learn more
www.reconnect.eu



06

How can I ensure NBS work for Disaster Risk Reduction?

Risk assessment
for DRR

Illustration of
monitoring
and assessment of
NBS for DRR

Why is it important
to evaluate the
impacts of NBS?

What constitutes NBS monitoring?

How do I develop a robust NBS monitoring
plan?

How can I execute monitoring and impact
assessment activities?

What indicators of NBS impact can I use?

How do I select appropriate indicators of
NBS impact?

What kinds of NBS
monitoring data
can I gather, and how
should I manage these
data?

6 NBS FOR DISASTER RISK REDUCTION

Coordinating Lead authors

Nadim, F., Tacnet, J.-M.

Contributing authors

Basco Carrera, L., Capobianco, V., Caroppi, G., Gerundo, C., Giugni, M., Manojlovic, N., Oen, A., Pilla, F., Piton, G., Porcu, F., van Cauwenbergh, N., Scheuer, S., Vojinovic, Z.

Summary

What is this chapter about?

Losses and damages due to natural hazards can be dramatic. This chapter provides a global overview of the requirements for risk assessment in the context of Disaster Risk Reduction (DRR). It outlines how NBS as structural measures can effectively reduce risks related to hydro-meteorological disasters, at the same time providing multiple co-benefits. As NBS may lack sufficient physical capacity to provide adequate protection against extreme events, the chapter illustrates how in most cases a hybrid combination of NBS and technical engineering (i.e., green and grey) measures can provide the optimal solution when DRR is the primary goal.

Next, we introduce the assessment of effects and co-benefits of NBS. These co-benefits should be included in cost-benefit analyses when comparing NBS with grey or hybrid solutions. Case studies illustrate selected implementation pathways and exemplify indicators and assessment frameworks that can be used

to assess different aspects of technical, physical, economic, social, human and environmental features of NBS.

How do I use this chapter in my work with NBS?

The frameworks, indicators and case study examples provided in this chapter can be used to design a monitoring and evaluation system for an existing or planned NBS for DRR.

When can I use this knowledge in my work with NBS?

Assessing the effectiveness of NBS at regional or local level for DRR in the context of hydro-meteorological hazards requires a detailed assessment of the risk level and the expected impact of the implementation of NBS. The knowledge presented in this chapter will assist in designing the monitoring and evaluation system for this purpose, including the selection of appropriate criteria and methods.

How does this chapter link with the other parts of the handbook?

This chapter expands the discussion of NBS impact evaluation from the city scale (chapters 1-5) to the catchment scale in the context of large-scale NBS for disaster risk reduction, with a primary focus on hydro-meteorological risk reduction.

6.1 NBS and Disaster Risk Reduction

As mentioned in the opening sentence of Chapter 1, urban areas cover less than 4% of land all around the world. Yet, almost all of the NBS-related research projects funded by the European Commission (EC) before 2018 focused on problems in urban areas. Nearly 50% of the rural areas in the world are classified as mountainous regions and are exposed to risk from geological and hydro-meteorological hazards. Mountains tend to amplify these risks, and even more so under extreme weather events. However, rural mountainous regions do not receive the same attention as densely populated urban areas in national disaster risk reduction (DRR) plans. National DRR plans focus mainly on regions with highest population density, which tend to be urban and/or coastal areas. Impacts of extreme hydro-meteorological events in mountain areas often affect entire river basins. Some of the natural hazard-related disasters in urban and coastal areas such as flooding caused by landslide dam breaks during and after storms are due to processes and events like flash floods and landslides that initiate in hilly and mountainous regions higher up in the river basin. Nature-based Solutions (NBS) have many advantages to fulfil disaster risk reduction objectives but their implementation is still limited because of lack of evidence of their effectiveness. Four recent H2020 projects – NAIAD, PHUSICOS, OPERANDUM and RECONNECT – focus fully or partially on demonstrating the effectiveness of nature-based solutions and their ability to reduce the impacts from small, frequent events (extensive risks) in rural mountain landscapes and in coastal areas. To demonstrate the effectiveness of NBS in achieving DRR objectives and to measure

their co-benefits, specific methodologies and measurable indicators are needed to provide evidence to stakeholders and decision-makers.

The previous chapters of this handbook review the existing indicators for all environmental challenges in which NBS may be considered. However, it appears that the existing frameworks related to indicators for measuring the effectiveness NBS only partially address the issue of disaster risk reduction. Evaluating the effectiveness of risk reduction measures, and especially NBS, requires understanding and describing the effects of measures (i.e., their physical capacity) on phenomenon's nature, intensity and frequency. The concept of effectiveness itself and the related indicators are linked to the comparison of an objective assigned to a function and a capacity (see Chapter 2).

In the critical domain of disaster risk reduction, demonstrating the physical effects of those measures is therefore a first essential step towards their successful implementation. However, in addition to this somewhere classical and expected effect, NBS can offer other co-benefits that conventional grey infrastructures (e.g., dams, levees) do not provide in terms of environmental, economic, social co-benefits. Indicators in the DRR context are not only physical; they should include other categories like risk perception, environmental impacts, and economic effectiveness.

This chapter extends the existing framework and proposes to address this challenging topic by taking benefit of recent projects dedicated to hydro-meteorological risks, mainly NAIAD, PHUSICOS, RECONNECT and OPERANDUM⁵¹. It first recalls briefly natural risks contexts, basics of risk assessment, risk reduction measures and then describes relevant indicators and principles that should guide indicator selection for disaster risk reduction. It focuses on the role of NBS for adaptation to and mitigation of impacts of weather events – with some examples taken from projects' representative case studies.

6.2 Basics of risk analysis, risk reduction measures, resilience and effectiveness

Defining, selecting and assessing indicators of NBS effectiveness in the context of DRR is linked to the understanding of risk concepts and the possible effects that NBS may have on those risk components. Depending on phenomena (e.g., floods, mountain-flash floods, debris-flows, landslides, rock falls), the physics of hydrological, geophysical processes may differ, although a common approach can be applied. This section presents those common points.

Risks result from a combination of hazard (frequency and intensity), exposure and potential losses as a function of vulnerability and values. Here, vulnerability represents the degree of damage or loss when an exposed element such as an

⁵¹ NAIAD: <http://naiad2020.eu/>; PHUSICOS: <https://phusicos.eu/>; RECONNECT: <https://reconnect-europe.eu/>; OPERANDUM: <https://reconnect-europe.eu/>

object, a person, or an activity is impacted by a given level of phenomenon intensity (Figure 6-1).

Intensity depends on the considered phenomenon and its several possible effects. For instance, mountain floods are not only composed of water but also transport solids (sediment and large wood). Measuring only water height may, therefore, not be relevant for computing damages, first, because of bed level change due to deposition or erosion, and, second, because these changes and/or damages due to material load may be the main cause of damage rather than the mere submersion by water (Figure 6-2).

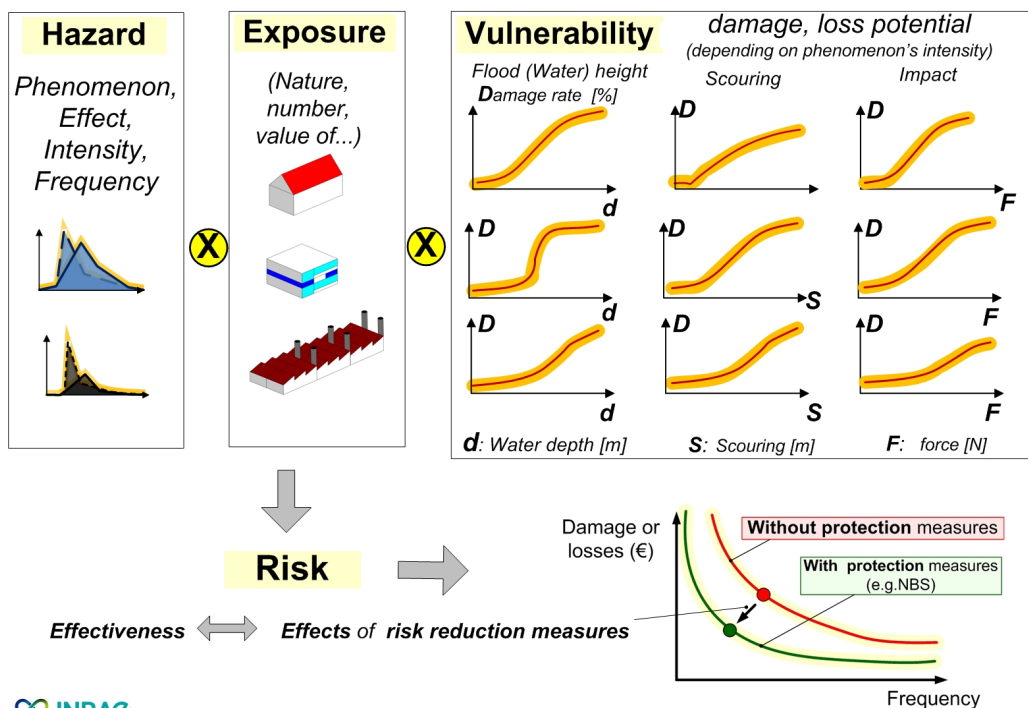

Figure 6-1. Basic components of risk: the effectiveness of a risk reduction measure requires to analyse its effects on the phenomenon including (1) the nature of the effects (e.g., flooding, scouring, impact of boulders); (2) their frequency; and (3) their intensity (e.g., flood depth) and their interaction with exposed elements (exposure and vulnerability as a potential of damage).

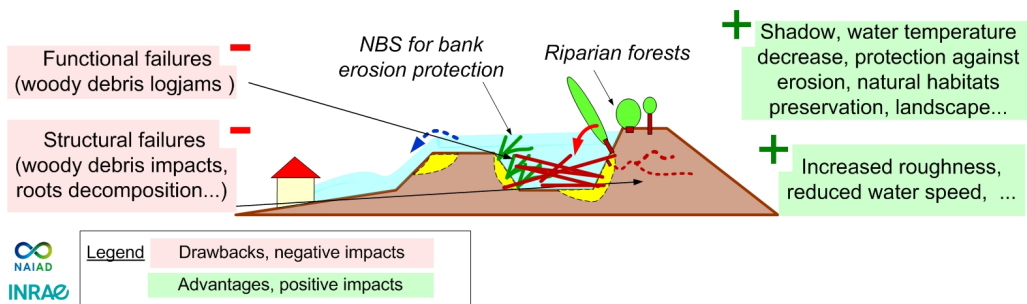

Figure 6-2. Positive and negative effects of NBS on phenomena and protections' physical features are addressed to assess measures' effectiveness (Tacnet, 2019).

Risk reduction measures consist of both structural (physical) measures such as protective structures (e.g., check dams) or non-structural measures such as land-use management, land-cover control and risk mapping (Figure 6-3). Structural measures aim to reduce risk by having a physical effect on the main characteristics of a phenomenon (e.g., reducing run-off on a given territory).

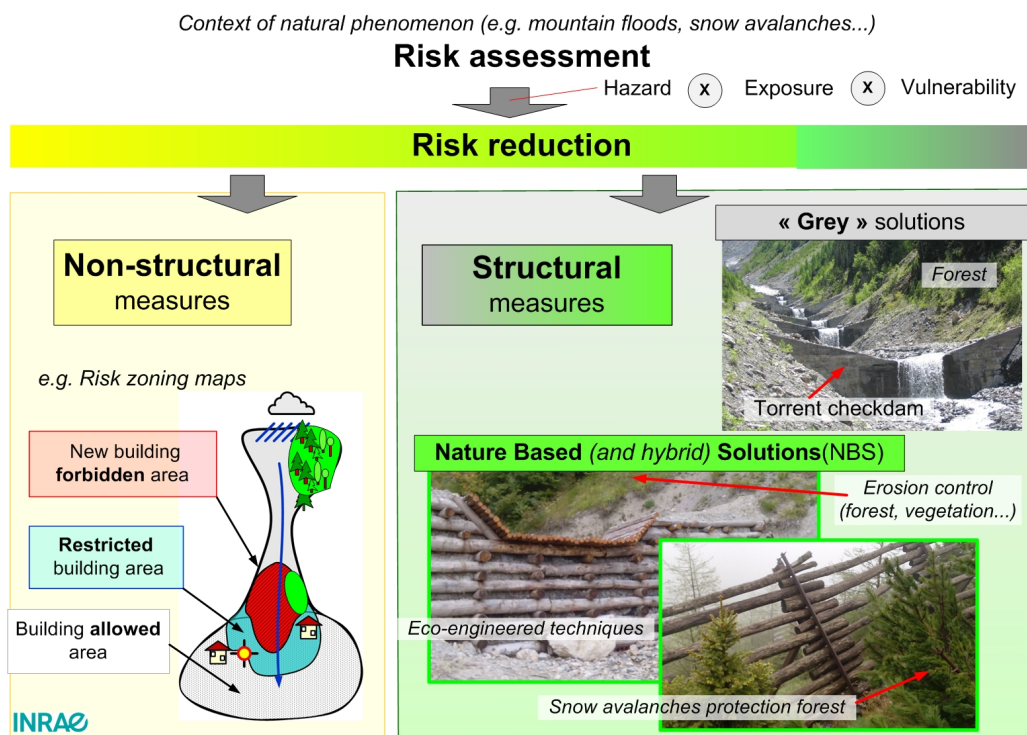
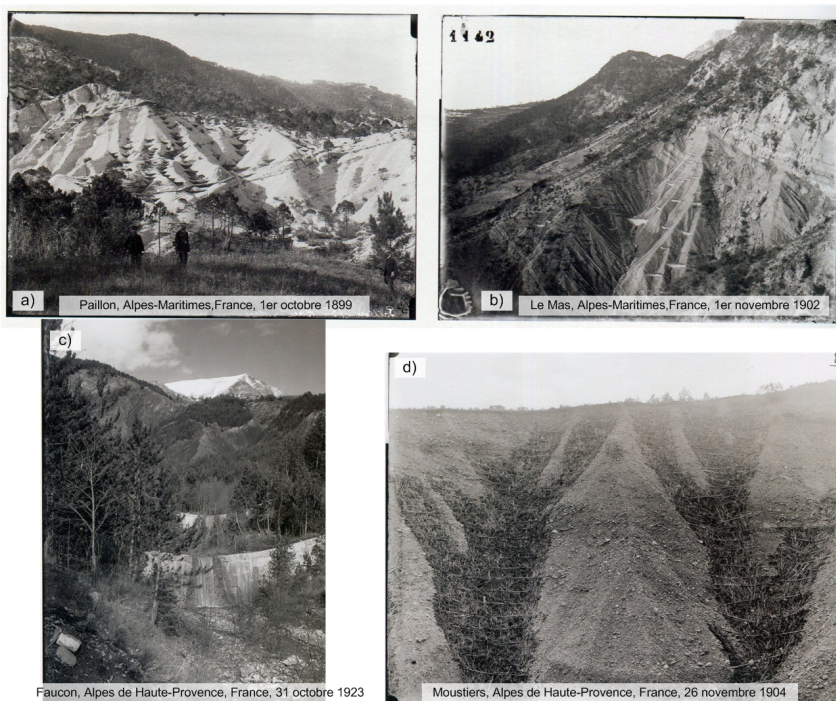

Figure 6-3. When dealing with DRR, Nature-Based Solutions are part of structural risk reduction strategies.

Nature-based solutions can therefore be considered as a structural measure dedicated to having an effect on the hazard component of risk (i.e., on the frequency or intensity of a given phenomenon). According to Evette et al. (2009), living plants have been used for a very long time throughout the world in structures against soil erosion, as traces have been found dating back to the first century BC. In Western Europe, bioengineering was widely practiced during the eighteenth and nineteenth centuries. For instance, since the 19th century in France, soil restoration, protection forests, gully restoration and planting as well as torrent check dams have been aiming to reduce sediment production and risks to people and assets in the valleys. Many techniques and hybrid combinations with civil engineering solutions are therefore not new (Figure 6-4). However, characterising the effectiveness of those measures remains difficult.



13. Source Conseil Général des Bouches du Rhône, Museon Arlatan, 2004 « Restaurer la montagne, Photographies des Eaux et Forêts du XIX^{ème} siècle ».

Figure 6-4. Combination of civil-engineered solutions and reforestation (which can be defined as Nature-Based Solutions) have been experimented successfully since the 19th and 20th century for mountain restoration purpose⁵², here with an example from the south eastern French Alps.

⁵² See *Restaurer la montagne. Photographies des Eaux et Forêt du XIXe siècle*. Brugnot, G., Coutancier, B. et al., Paris: Somogy éd. d'art, ISBN: 2-85056-801-5, 188 p.

For flood risk management, many types of NBS exist, each of them corresponding to a specific expected function that will be analysed to check their effectiveness⁵³ through their comparison between their physical capacity (e.g., a storage volume) and an objective linked to this function (e.g., volume needed) (Figure 6-5).

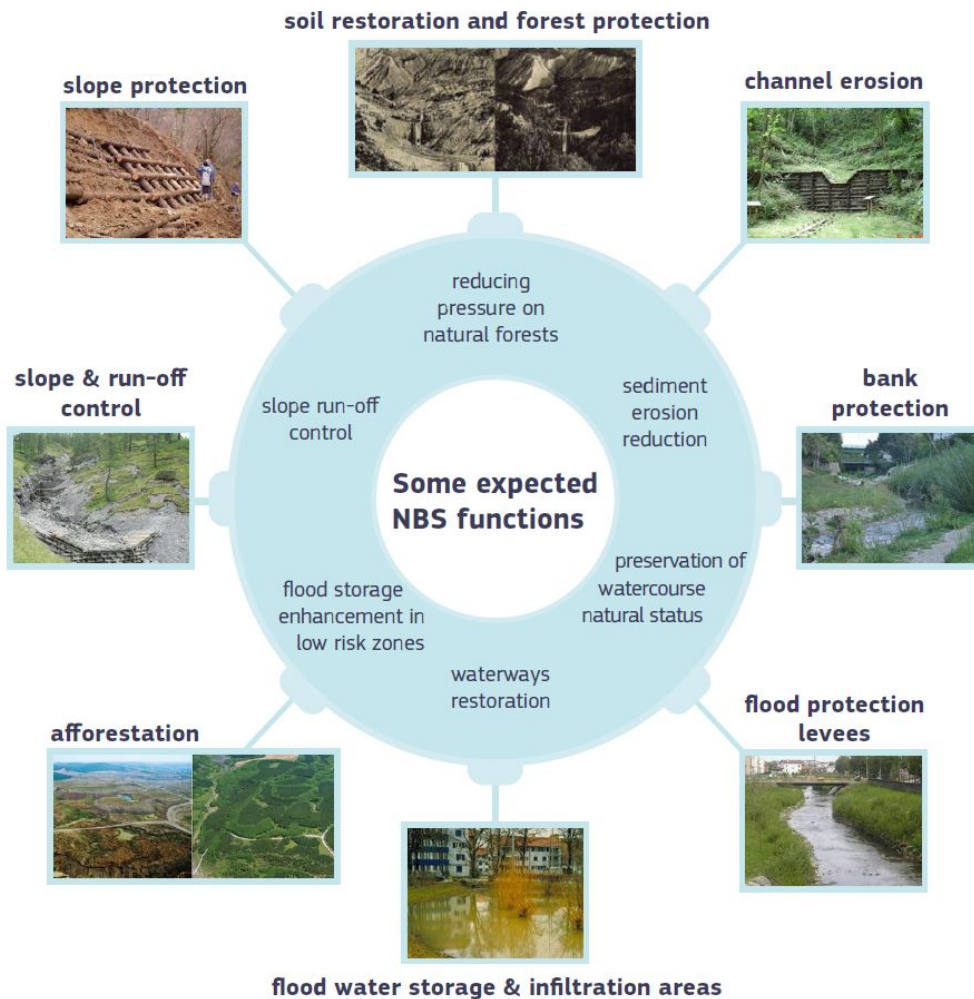

14.

Figure 6-5. NBS used for flood risk management have different functions.

⁵³ See chapter 2 for a definition of effectiveness

6.3 Indicators and methodologies for measuring NBS effectiveness indicators in DRR context

Several recent H2020 projects address the analysis of the effects of NBS. NAIAD, PHUSICOS, RECONNECT and OPERANDUM projects propose generic assessment frameworks for measuring the effectiveness of an NBS that is primarily designed for DRR.

The NAIAD framework is designed for effectiveness assessment and decision-making with respect to the choice of best NBS measures and strategies. The different steps of disaster risk reduction and contributions of NBS are studied within the NAIAD project considering technical, physical but also social, human, environmental and economic features (Figure 6-6). A specific methodology is designed to determine the indicators. Relevant indicators are defined by experts and stakeholders through workshops. A two-level approach is proposed making a difference between technical analysis and decision-making contexts. Expert and technical assessments are used as inputs in a multicriteria decision-making framework which allows to address all kinds of technical, environmental, economic, or social features, and to consider stakeholder preferences as identified during participative workshops (Figure 6-7).

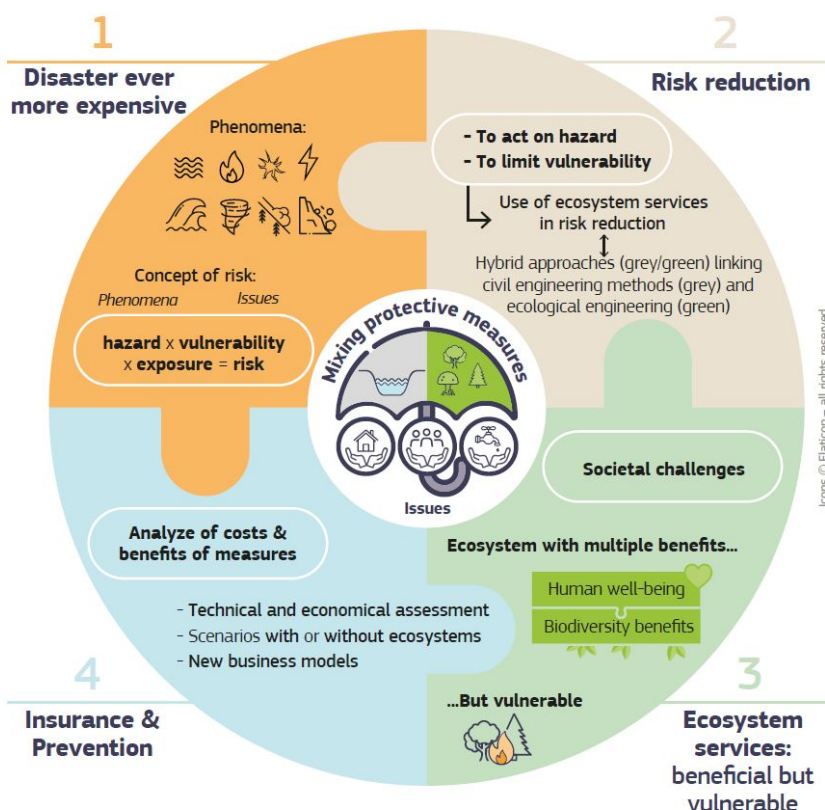

Figure 6-6. NAIAD’s global framework to assess role of NBS in Disaster Risk Reduction (DRR).

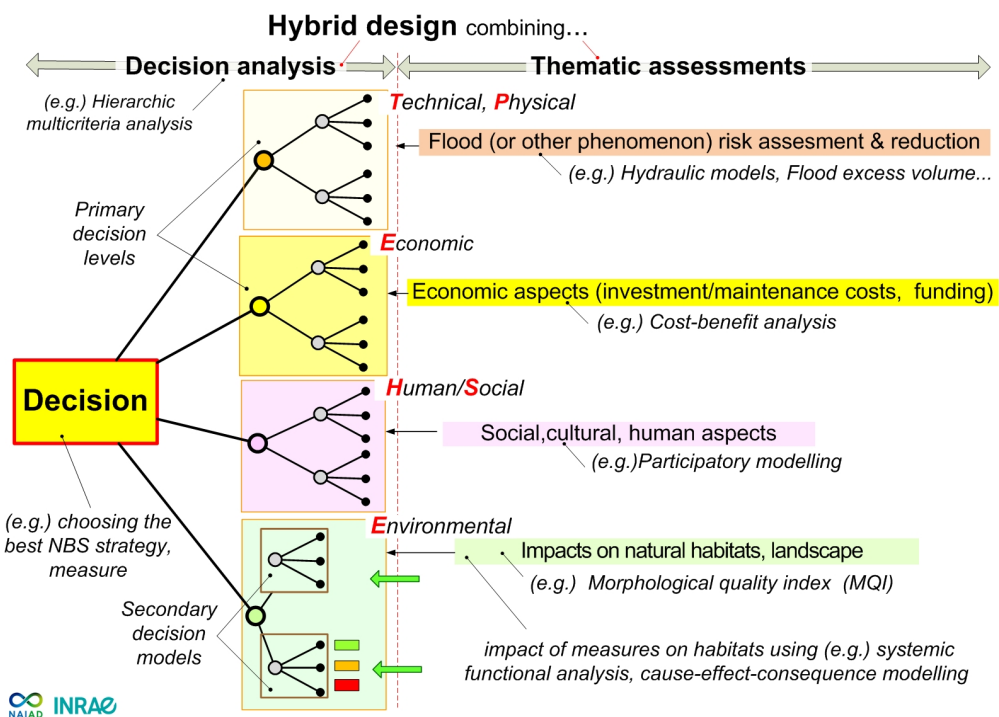

Figure 6-7. A multicriteria decision-making framework allows to integrate and combine technical, physical, environmental and economic indicators. Decision makers express their preferences on high-level criteria (protection level, economy of projects, social/cultural and environmental impacts). Experts provide and assess indicators for those categories (adapted from Tacnet et al., 2018).

Regarding DRR, the indicators for measuring the NBS effectiveness in the NAIAD framework are linked to physical effects of measures at different scales. The NAIAD framework is applied ex-ante, the indicators related to physical effects are thus assessed by a combination of numerical modelling and geomorphological analysis. NAIAD proposes a global hierarchical model to combine indicators for various aspects including technical, physical, organisational, environmental, social/human and economic features (so-called TOPHEE approach) in order to assist the decision-making process.

The projects PHUSICOS, RECONNECT and OPERANDUM all focus on NBS for reducing the risk of hydro-meteorological hazards. However, they approach the problem from different viewpoints and their recommended frameworks have their distinct characteristics. Table 6-1 compares some of the characteristics of these frameworks. All three frameworks are built on the basis of the hazards addressed in the case study sites of each project. For example, RECONNECT focuses only on flood and drought risk; PHUSICOS on landslides, snow avalanches, floods and drought; and OPERANDUM focuses on a larger spectrum of hazards (Shah et al., 2020), including coastal erosion, storm surge, nutrient and sediment accumulation, soil salinization, heat waves, and dust storms found in the Open Air Laboratories (OAL).

PHUSICOS and RECONNECT have both selected the risk and co-benefits categories, as well as the initial set of indicators to be assessed on the basis of existing NBS projects, platforms and literature, with a focus on the challenges indicated by the EKLIPSE project. A different approach was adopted by the OPERANDUM team, who identified the indicators through the review of literature available for each of the OAL-specific hazards, together with stakeholder involvement in surveys and focus group discussions. In the OPERANDUM framework, once the potential indicators are identified, their final selection is based on four criteria: Credibility, Salience, Legitimacy, and Feasibility. Stakeholders are involved in all processes, from the co-design of the framework to the co-selection of the indicators, based on their specific needs and priorities. The OPERANDUM framework has not been tested yet, while the other two frameworks were tested on a real NBS case in Thailand within the RECONNECT project, and for three hypothetical scenarios in PHUSICOS: (1) the Baseline Scenario before implementation of any mitigation measure; (2) a NBS Scenario; and (3) a Hybrid Scenario.

Based on the tests carried out to date, it can be noted that RECONNECT approach has been solely used for ex-post assessment of a NBS scenario for potential replication, up-scaling or improvement. This is different from the PHUSICOS framework, which can be used also as a decision-making tool to compare the potential performances and co-benefits of different design scenarios for a specific context prior to their implementation. A main feature of the RECONNECT framework is that each indicator is expressed in a relative manner, i.e., as the difference between its value in the NBS scenario and in the scenario without NBS, whilst for PHUSICOS and OPERANDUM the indicators are expressed using absolute values. This difference highlights the importance that the RECONNECT project attributes to the NBS co-benefits. PHUSICOS and OPERANDUM systematically address the risk reduction provided to a specific context, in terms of changes in exposure, vulnerability and hazard. Furthermore, the OPERANDUM framework treats both the ecosystem and the society as elements exposed to risks posed by hydro-meteorological hazards at each specific OAL, highlighting again the adopted risk-oriented approach.

A general observation that can be made is that the RECONNECT framework is benefits-oriented, the OPERANDUM framework is risk-oriented, and the added value of the PHUSICOS framework is balanced and neutral: risk reduction indicators and co-benefits indicators are structured in a way that the stakeholders can state their preferences through weights assigned to each indicator. An added value of the OPERANDUM framework is that it is applicable from a local to regional/national scale, while both RECONNECT and PHUSICOS are mostly focused at local or catchment scale. An added value of the RECONNECT framework is that it includes, as last step of the evaluation, an analysis of a so-called NBS grade, focusing on the weakest indicators, so that experts and stakeholders can provide recommendations for all indicators, or only those with low scores. Recommendations can include guidance on how to better involve stakeholders in every step of the framework, how to better measure, collect, and analyse data, and how to maintain the NBS to maximize benefits. Finally, all three frameworks are highly flexible, and they can be adapted or redefined to the context where they are applied, depending on the needs of the stakeholders and the most suitable indicators to be assessed.

Table 6-1. Key features of the frameworks developed in EC H2020 hydro-meteorological risk reduction projects (based on partial examples presented in case studies).

Framework aspect	NAIAD	RECONNECT	PHUSICOS	OPERANDUM
Key features of the frameworks	Integrated hybrid approach mixing classical engineering, environmental and geomorphological approaches but also systemic analytical, economic and multicriteria decision-aiding frameworks	Five main sequential steps, from the selection and the evaluation, to the scoring of the main indicators for the assessment of the benefits of an implemented NBS	Based on a multicriteria decision analysis (MCDA), which assesses, through a matrix containing indicators aggregated in different sub-criteria, the risk reduction performance and the co-benefits of a design scenario for a specific site	Vulnerability and risk assessment framework, aimed at looking at the impacts of hydro-meteorological hazards on an exposed social-ecological system
Source for the identification of the initial set of indicators	Multidisciplinary indicators, either from existing methods (e.g., EU Reform project for morphological quality index) or self-created (e.g., flood excess volume, FEV)	Indicators as well as the three benefit categories where they fall in (Water, Nature, People), based on the challenges indicated by the EKLIPSE project	Indicators are selected after an extensive review of the main existing NBS project networks and platforms, as well as the challenges indicated by the EKLIPSE project	Systematic literature review combined with stakeholders and expert surveys and focus group discussions
Type of hazards addressed	Flood	Flood, drought	Flood, landslide, snow avalanche, drought	Hydro-meteorological but can be applied to any natural hazard
Main categories	Integrated risk management, Multifactorial NBS effectiveness assessment, Decision-aiding	Water, Nature, People	Risk reduction, Technical and feasibility aspects, Environment and ecosystems, Society, Local Economy	All components of risk (hazard, exposure (social and ecological sub-systems), and vulnerability (social sensitivity and coping capacity; ecosystem

				sensitivity and robustness)
Indicator types	Multicriteria technical, physical, environmental, social/human, organisational indicators (relative, comparative and absolute values) – TOPHEE approach	Relative value	Absolute value	Not specified, but absolute value is implied followed by normalization
Stage of assessment	Ex-ante assessment	Ex-post assessment (can also be applied for Ex-ante assessment)	Ex-ante assessment and Ex-post assessment	Ex-ante (can be visualised, e.g., with scenario development)
Spatial scale of application	Local or catchment scale (can be extended to regional or global scale)	Local or catchment scale	Local or catchment scale	Local to basin scale
Environmental context		Urban and rural environmental contexts		
Stakeholder level of involvement	Stakeholders are involved in the indicator selection process (workshop), the assessment process (validation, communication of technical assessment), the decision-aiding step (identification of preferences, assessment of solutions)	Stakeholders are involved in the process from step 1 (selection of indicators) to step 4 (evaluation of the NBS grade). It is not specified if they are actively involved also in step 5 (recommendations)	Stakeholders are involved in the refinement of the matrix for the specific site, as well as in weighing the ambits, criteria and indicators	Stakeholders are continuously involved, they help to co-design the framework, co-select the indicators, and give a prioritized list of indicators. They will be involved in weighing indicators

Outcome	Fully integrative and versatile framework from indicators design to their aggregation, NBS strategies and measures are assessed in a multicriteria perspective	NBS grade incorporating all the benefits assessed, equal to the average of the scores of each indicator quantified	Overall scenario scoring for comparing two different scenarios, or to assess a specific scenario performance over time	Risk to the social-ecological system
----------------	--	--	--	--------------------------------------

6.4 Case study #1 - NAIAD (La Brague, FR): from indicators assessment to integration and decision-aiding for flood risk management⁵⁴

6.4.1 Context and global framework for assessment of NBS effectiveness

Several scales and kinds of application test cases were considered in the NAIAD project⁵⁵. This case focuses on La Brague River in the south of France, where the effectiveness of nature-based solutions was addressed through a combination of physical, geomorphological and economic indicators. The Brague River basin is a 68 km² catchment located along the French Mediterranean coast between the cities of Cannes and Nice. The Brague is a short river, 21 km long, and is subjected to flash floods as well as woody debris production and transport. Mediterranean climate causes heavy rains mostly in autumn, and the floods of the Brague are often devastating and sometimes deadly. Over the period of 1970–2015, the Brague caused fourteen disastrous floods and eight deaths. The insured damages of the October 2015 flood (which had an estimated return period of over 100 years) amount to about 50 million € in the municipalities of Biot and Antibes. After this flood, several campsites located in the area were closed by state decision due to risk of being flooded. However, dozens of houses remain at risk. This regrettable event provided an opportunity to re-define the economic development strategy of the valley and to design new flood protection strategies to both protect people and infrastructure against flood risk, and to improve the river corridor's natural life, landscape and environmental quality.

Risk analysis is traditionally addressed through hazard and vulnerability assessment. The primary expectations of the selected nature-based strategies for the river corridor would be that these strategies are effective in reducing hazards from a physical point of view by storing water in the upper catchment while easing drainage without overflowing in the lowlands. NBS can provide other important co-benefits but they may appear as secondary if the protection level is not sufficient. When used alone, eco-engineering approaches can propose aesthetic solutions which may not be able to cope with required hydraulic capacity or be strong enough to resist to hydraulic constraints. NBS flood alleviation strategies studied for the Brague catchment are a combination of retention measures by small natural retention areas in the upper catchment, along with a widening of the river corridor in the lowlands enhanced by floodplain reconnection. Floodplain works consist of several measures including bed and bridge widening, forest corridor and wetlands restoration, and large woody debris management. They are integrated in a so-called "giving-room-to-the-river" strategy. Two levels of ambition, namely high and very high, are considered as well as a more classical grey scenario based on huge retention dams for comparison purposes.

NAIAD proposes both indicators and an original approach to formalize the concept of effectiveness to design, assess and combine ad-hoc effectiveness indicators (see also systemic analysis⁵⁶). A multidisciplinary approach draws on the

⁵⁴ J.-M. Tacnet, G. Piton (INRAE/NAIAD)

⁵⁵ See Deliverable 6.4 for an extended description of outputs

⁵⁶ See NBS handbook, Chapter 2

knowledge of experts in forest and river management, natural hazards (floods, erosion, wildfires), vulnerability and damage assessment, economy and decision-aiding to perform an in-depth study of the Brague River catchment and compare the effectiveness of possible grey (civil-engineered), green (nature-based solutions) and hybrid strategies. Experts' analysis and domain-specific methods are used as basic inputs to address technical, environmental and economic indicators. For instance, cost-benefit analysis is used to provide an indicator for economic effectiveness assessment, morphological quality index (MQI; Rinaldi et al., 2013) is used to assess the morphological status of the river while the flood excess volume (Bokhove et al., 2019, 2020) is used to measure the physical hydraulic capacity of measures and comparison with their economic features. Total costs of the three protection strategies were evaluated and compared with mean annual avoided losses (costs) based on historical events and theoretical floods with known return period. The co-benefits related to NBS strategies were also evaluated using two different methods (Arfaoui and Gnonlonfin, 2020a, 2020b). First, transfer of values based on a meta-regression-analysis of values provided in other catchments, and second, a contingent valuation performed locally through interviewing more than 400 persons in the basin. It should be stressed that several intangible criteria, e.g., the improvement of the natural status of the river, are poorly captured by the monetary methods and a complementary multicriteria decision framework was developed to handle both tangible and intangible criteria (Figure 6-7).

6.4.2 Indicators for assessment of technical, physical and economic efficacy of flood mitigation strategies including NBS

Indicators to describe the **environmental, ecological** and **geomorphological status** of a river have been estimated for the initial state and with assumptions corresponding to the different NBS strategies and scenarios (Figure 6-8 and Table 6-2). The morphological quality index (MQI⁵⁷) aggregates 28 indicators corresponding to geomorphological functionality, artificiality and channel adjustments. It captures degradation of the geomorphological quality of the river for the grey scenario (decreases in MQI, red cells in Table 6-2), whilst the NBS scenarios improve it (increases in MQI, blue cells in Table 6-2). These elements were meaningful for stakeholders interested in river restoration.

⁵⁷ Developed within the EU project REFORM (<https://reformrivers.eu>)

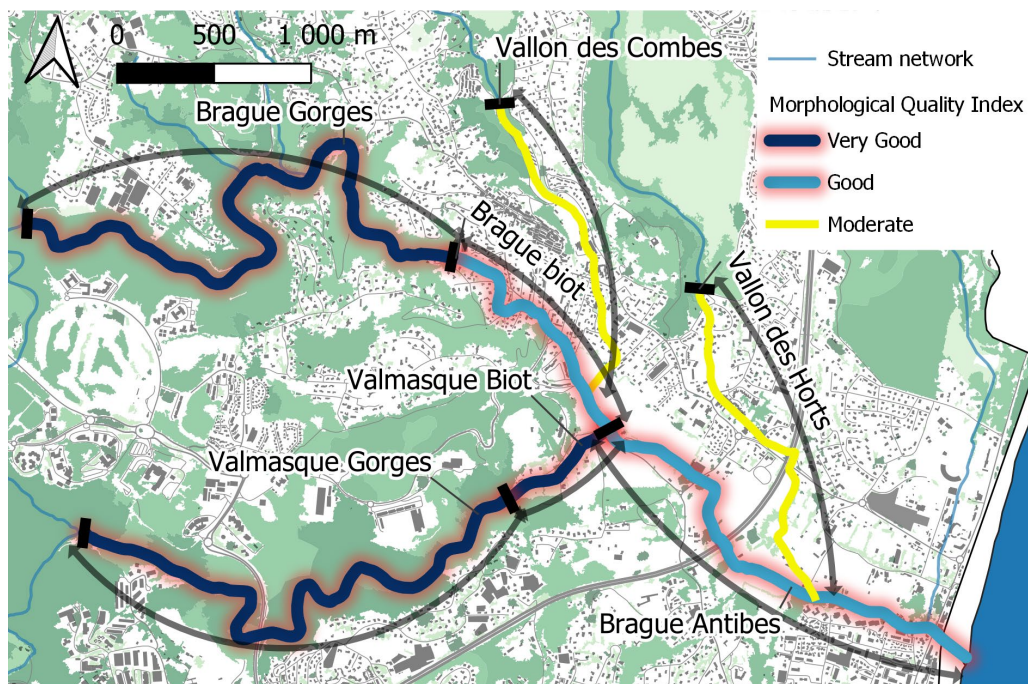

Figure 6-8. Map of Morphological Quality Index values – state based on data and maps in 2017.

Table 6-2. Morphological Quality Index values for the different reaches (status 2017) and values of intermediate aggregation. Those indicators are then used in the multicriteria decision-aiding framework.

Strategy	Reach	Brague Gorges #1	Brague Biot #2	Brague Antibes #6	Valmasque Gorges #5	Valmasque Biot #4
Current status	MQI _{current}	0.94	0.82	0.80	0.94	0.85
Grey	MQI	0.87	0.79	0.76	0.87	0.82
	MQI-MQI _{current} =ΔMQI	-0.07	-0.03	-0.04	-0.07	-0.03
NBS ambitious	MQI	0.97	0.86	0.90	0.97	0.88
	MQI-MQI _{current} =ΔMQI	0.03	0.04	0.1	0.03	0.03
NBS very ambitious	MQI	0.97	0.87	0.95	0.97	0.88
	MQI-MQI _{current} =ΔMQI	0.03	0.05	0.15	0.03	0.03

Note: MQI = 0 = river status totally altered; MQI = 1 = No alteration to the natural status

Providing an objective, easily understandable method to assess **indicators of physical and economic effectiveness** of NBS is essential to guarantee security but also to increase acceptance by stakeholders. The **Flood-Excess-Volume (FEV) method** has been developed to quickly assess cost-efficacy of flood-mitigation strategies by allowing generic flood-mitigation strategies to be tailored to specific river-catchment scenarios. Produced through a collaboration between the University of Leeds, UK, and the NAIAD project, it has been successfully tested on data accrued from real flood events occurring in the UK (Aire and Calder Rivers), France (La Brague, NAIAD demonstration) and Slovenia (Glinsisca river, NAIAD demonstration), see Bokhove et al. (2019, 2020) and Pengal et al. (2020).

FEV identifies and utilises indicators of flood severity that are quantifiable, easy to understand and to measure, hence making it objective, transparent to scrutiny and user-friendly. It is repeatable, flexible and capable of rapidly verifying whether or not a given ensemble of protection measures is sufficient to mitigate against *a priori* specified degree of flood severity. The input data required by the tool are the project-flood hydrograph (i.e., the water-discharge time series), the water stage-discharge curve (i.e., the channel capacity) and the threshold level (i.e., the discharge above which severe flooding occurs). In Figure 6-9, the computed FEV represents the amount of water that cannot be contained by existing flood defences for a given flood (Figure 6-9(1)). It then computes the size of a virtual lake, 2 m deep and square in shape, that could retain the computed FEV (Figure 6-9(2)). The last step is to split the lake into constituent components, each of which is associated with a specific flood-protection measure such as restored wetlands, leaky dams, floodplain reconnection, flood-retention dams and giving-room-to-the-river, and to compare with their relative costs (Figure 6-9(3)).

The tool has already proved useful in stakeholder workshops for raising public awareness of flood risk assessment. This visualisation — of a virtual square lake of human-scale depth — helps stakeholders to assimilate in a meaningful way the excess of water that must be contained and/or confined in order to offer flood protection. The simplified visualisation deliberately allows, and hence empowers, a wide, non-expert audience to comprehend the magnitude of the amount of water that needs to be contained/confined to mitigate flooding. The feedback from end-users has been unanimous: the tool has unequivocally bridged the gap between the design of local measures that were formerly unable to establish the full picture of the catchment size flooding with advanced numerical modelling that was, although powerful and precise, either too slow or too computationally expensive to explore a plethora of potential protection strategies in a cost-efficient manner.

In essence, it is by tailoring our approach to the catchment peculiarities using relevant tools with various degrees of complexity that NAIAD helped decision-making in the Brague catchment.

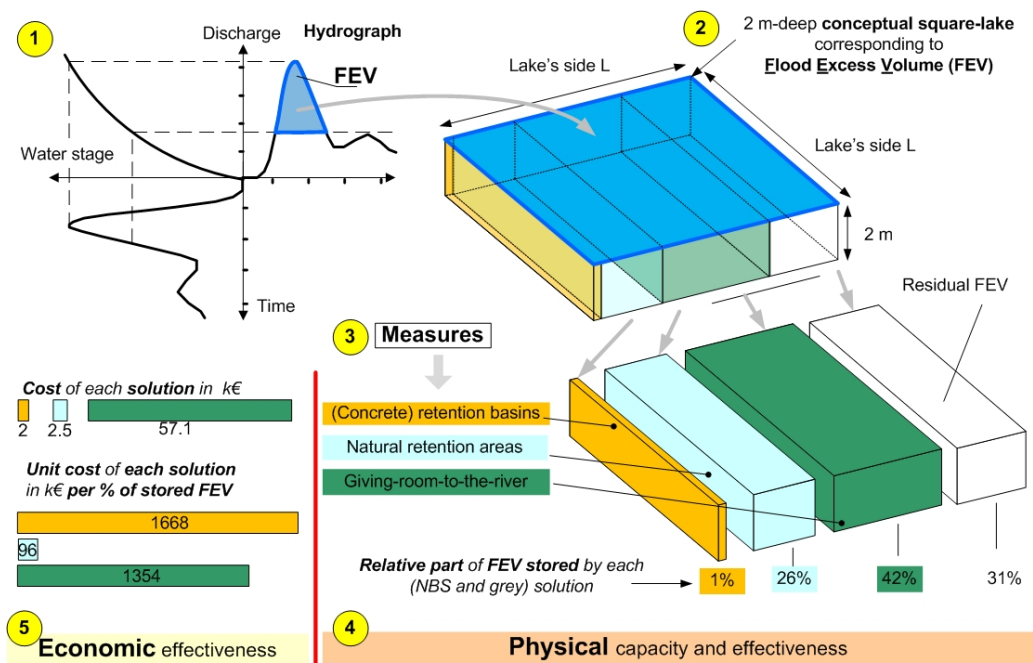

In collaboration with

Figure 6-9. Different steps and results of Flood Excess Volume methodology: physical and economic effectiveness of Nature-Based solutions are assessed and compared for different strategies.

6.5 Case study #2: A green barrier to reduce the risk of floods due to snowmelt and extreme rainfall, Gudbrandsdalen Valley, Norway

6.5.1 General background and hazard type

The Gudbrandsdalen is one of the most populated valleys in Norway. The valley encompasses an area of ca. 15 km² and is rich in floodplains along the river, which are extensively used as farmland. Due to lack of other available land, many settlements are located along the river. Historically, the valley is susceptible to snowmelt flooding. However, this has been changing in recent years with an increased risk of flooding due to heavy rainfall, also in combination with snowmelt. Two major flood events in 2011 and 2013, causing massive damages to infrastructure along the river (Figure 6-10), were the driving factors behind the initiative to develop a Regional Master Plan for the Gudbrandsdalen and its tributaries. The master plan proposes providing more "room for the river" in flood-prone locations.



Figure 6-10. Valley of Gudbrandsdalen during the flood of 2013.

6.5.2 *Co-benefits of the proposed NBS*

The receded green barrier will provide space for the river during periods of flooding, foster the natural processes in the watercourse and thus contribute positively to the floodplain ecosystem. The landscape architect company AgenceTer (PHUSICOS partner) highlighted the potentialities of the receded barrier through its support of multiple activities such as a fishing platform, picnic area, and panoramic views, also maintaining the scope of the barrier to be "in line with the landscape". Other measurable co-benefits include an enhanced local economy that will benefit from the reduced risk of inundation of the agricultural lands behind the green barrier. However, with this solution, few agricultural lands are expected to be floodable (Figure 6-11) and this caused some discontent among stakeholders.



Figure 6-11. Aerial photo of the area with the location of the existing flood barrier and the new flood barrier (top); Visualization of the area with the potential multiple actions that can be supported by the flood barrier (by AgenceTer, bottom).

6.5.3 Indicators for the NBS performance assessment

The indicator matrix tailored to this demonstrator site encompasses a total of 47 indicators. Quantitative, risk-related indicators include *Peak Flow volume*, *Flooded Area* — calculated through hydraulic modelling — and *Exposed residential and productive areas*, obtained by GIS mapping. Ecosystem indicators are aimed to assess both the effects on water quality, such as the *Change in physical and*

chemical water parameters, and water quantity, such as the *Total predicted soil loss (RUSLE)*, or enhanced *Water storage capacity*. Indicators for assessing the improved value of the forested floodplain include *Typical vegetation species cover*, and *Diversity in plant and animal functional groups*. Societal-related indicators include the *Number of visitors in the new recreational areas* and *New pedestrian/cycling paths*, whilst the *Number of jobs created in the nature-based sector* is one of the economy-related indicators. The variables and key performance indicators selected to be monitored in the Gudbrandsdalen demonstrator site are listed in Table 6-3.

Table 6-3. PHUSICOS project key performance indicators (KPIs) to be evaluated for Gudbrandsdalen demonstration site.

Ambit	Criterion	Sub - Criterion	Indicator	Metric	
RISK REDUCTION	Hazard	Flooding Risk Resilience	Peak Flow	m ³ /s	
			Flooded Area	ha	
	Exposure	Potential Areas Exposed to Risks	Urban /Residential Areas	ha	
			Productive Areas (Agriculture, Grazing, Industries)	ha	
			Potential Population Exposed to Risks	Inhabitants	no./ha
				Other People (Workers, Tourists, Homeless)	no./ha
		Elderly, children, disabled		no./ha	
		Potential Buildings Exposed to Risks	Housing	no.	
			Agricultural and Industrial Buildings	no.	
			Potential Infrastructures Exposed to Risks	Roads	km
		Lifelines (Water main, Sewerage, Pipeline, etc.)		m/km ²	

	Vulnerability	Potential Population Vulnerable to Risks	Population	no.		
		Potential Economic Effects due to Risks	Economic Value of the Productive Activities Vulnerable to Risk (i.e. Economic Value of the Fields, Workers No.)	€/km ²		
		Potential Infrastructures Vulnerable to Risks	Buildings	No./km ²		
			Transportation Infrastructures and Lifelines	m/km ²		
		TECHNICAL & FEASIBILITY ASPECTS	Technical Feasibility (Affordability)	Cost-Benefit Analysis of the Intervention	Initial costs	million €
					Maintenance costs	million €
Replacement costs	€					
Avoided costs	million €					
Payback Period	years					
Application of Suitable Materials and Technologies	Material used coherence			0/1		
ENVIRONMENT & ECOSYSTEMS	Water	Effects on Water Quality	Physical parameters	°		
			Chemical Pollution Parameters	-		
			Water Storage Capacity Enhancement	m ³		
	Soil	Soil Physical Resilience	Total Predicted Soil Loss (RUSLE)	T·ha ⁻¹ ·yr ⁻¹		
	Vegetation	Typical Local Species Promotion and Development	Typical Vegetation Species Cover	-		
	Landscape (Green Infrastructure)	Green Infrastructure	Abundance of Ecotones/Shannon Diversity	km/ha/Shannon index		

	Biodiversity	Functional Diversity	Diversity of Functional Groups (Plant Functional Diversity)	Shannon index
			Diversity of Functional Groups (Animal Functional Diversity)	Shannon index
		Protected Areas	Site Community Importance (SCI) And Special Protection Areas (SPA)	ha
SOCIETY	Quality of life	Leisure and Connections Increasing	Number of Visitors in New Recreational Areas	no.
			Different Activities Allowed in New Recreational Areas	no.
			New Pedestrian, Cycling and Horse Paths	m
		Social Justice	Rate of Increase in Properties Incomes	%
	Community Involvement and Governance	Participatory Processes and Partnership	Citizen Involved	no.
			Stakeholders Involved	no.
			Public-Private Partnership Activated	no.
			Policies Set Up to Promote NBS	no.
	Landscape and Heritage	Identity	Social Active Associations	no.
		Heritage Accessibility	Natural and Cultural Sites, Made Available	no. of sites

		Landscape Perception	Viewshed	km ²
			Scenic Sites and Landmark Created	no.
LOCAL ECONOMY	Revitalization of Marginal Areas	Promotion of Socio-Economical Development of Marginal Areas	Jobs Created in The Nature-Based Sector	no.
			Jobs Created in The Nature-Based Solution Construction and Maintenance	no.
			Gross Profit from Nature-Based Tourism	€/area/y
			Touristic Activeness Enhancing	no. visitors/y
	Local Economy Reinforcement	New Areas for Traditional Resources	New Areas Made Available for Traditional Activities (Agriculture, Livestock, Fishing, ...)	ha

6.6 Case study #3: Landslides and debris flows, Portofino Natural Park, Italy

The Portofino Promontory (Liguria, Italy) belongs to the Natural Regional Park of Portofino, located between Genoa and the border with Tuscany. The promontory encompasses an area of 18 km², with a coastal development of 13 km. The terrain topography is rather mountainous, with high elevations over a short distance from the coastline (e.g., Mt. Portofino with an elevation of 610 m above sea level). Due to its unique geomorphological features, the Portofino Promontory is historically affected by geological instabilities produced by meteorological events, with potential impacts to the elements at risk. The most frequent hazards are (1) shallow landslides and flash floods; (2) sea storm surges; and (3) rock falls and mud-debris flows.

Considering the high naturalistic value of the area, NBS are the most suitable risk mitigation measures to be adopted, to conserve landscape, natural and cultural heritage, and touristic value of the promontory. The primary NBS ambition in San

Fruttuoso is to address the following challenges: (1) stabilisation of rock masses; (2) reduction of geo-hydrologic risks in order to intercept and reduce the floating and solid transport along the rivers and to reduce erosion; (3) wood amelioration, by removing allochthones and degraded species of old vegetation; and (4) construction of dry stone walls and restoration of abandoned terraces, with the aim to valorise the terraced landscape and promote agricultural activities.

The RECONNECT project foresaw the selection, installation, and operation of hydro-meteorological instruments that will include three weather stations, two hydrological measuring stations, and two cameras. The necessary equipment will be purchased and installed once the selection of indicators for the evaluation of NBS is complete. Monitoring activities further include remote sensing activities such as LIDAR surveys, orthophotography, and infrared aerial photography.















The RECONNECT project team has identified the key variables and indicators that need to be monitored and assessed in all NBS demonstration sites. The variables and key performance indicators selected from the original performance indicator table to be monitored in the Portofino Natural Regional Par, are listed in Table 6-4. These assessments will be cross-referenced and compared with other RECONNECT sites that have similar morphological features (Turconi et al., 2020).

Several benefits and co-benefits are expected to be obtained from the Portofino NBS demonstration case:



1. Decrease of geo-hydrological vulnerability for the main infrastructures and the cultural heritage;
2. Re-building/maintenance of dry stone walls, which will contribute to the restoration of old terraces and will re-incentivize agricultural activities with benefits for the farmers, as well as for geo-hydrological risk mitigation;
3. Decrease of the impacts by landslides and slope instability at the coastal sediment amount level;
4. Decrease of the risk of injuries among the park visitors due to slope instability of interesting hiking paths during heavy rainfalls;
5. Support for the interaction between private landowners;
6. Integration of the proposed NBS with regional policies for land management/planning and with the Basin Master Plan;
7. Improvement of the visibility and governance model of the Portofino Natural Regional Park, also in the perspective of becoming a National Park; and
8. Improvement of the collaboration between the park authority and stakeholders.

Table 6-4. RECONNECT project key performance indicators (KPIs) to be monitored in the Portofino Natural Regional Park area (following Turconi et al., 2020).

	Performance key indicator	Variable	Base-line ¹	Specific Monitoring Details		
				Monitoring Approach	Data ²	Phase ³
WATER	Possible source of debris/hyper-concentrated flow	Precipitation (mm), Rainfall intensity (mm/h)	✓	Weather stations (a)		2
		Maintenance level of man-made terraces	(b)	Assessment of terraced area extent (e.g., LIDAR), Aerial photo interpretation and Field survey to evaluate terrace conditions		2
	Floating transport in hydrographical network	Dead trees within 20 m buffer along the hydro-graphical network		Field survey		2
	Landslide reduction—debris and hyper-concentrated flow triggering	Land use	✓	Aerial photo interpretation		2
NATURE	Changes in riparian habitat	Riparian habitat area (km ²)	✓	Aerial photo interpretation and Field survey		2
	Changes in terrestrial habitat	Terrestrial habitat area (km ²)	✓	Aerial photo interpretation and Field survey		2
	Changes in vegetation along watercourses	Vegetation along watercourses (survey)	✓	Aerial photo interpretation and Field survey		2
		Trends and status of range	✓	Aerial photo interpretation and Field survey		2
		Trends and status of the area	✓	Aerial photo interpretation and Field survey		2
		Structure and function including typical species	✓	Aerial photo interpretation and Field survey		2
	Change in land cover	Land cover		Aerial photo interpretation		1
	Number and type of protected species	Type of protected species	✓	Field survey		2
Number of protected species		✓	Field survey		2	

PEOPLE	Footpath network recovery through erosion reduction and improvement of path smoothness	Length of improved path		Field survey		2
		Water drainage improvement		Field survey		2
	Increasing recreational opportunities of NBS area	Number of recreation activity in the area		Field survey		2
	Number of tourists	Number of tourists		Automatic counter		2
	Maintenance and management cost of NBS	Economic losses and properties loss during hydro-meteorological events		Survey		2
		Cultural heritage loss		Survey		2
	Reduced need for management and maintenance	Maintenance and management cost of grey infrastructure (if implemented)		Survey		2
		Maintenance and management cost of NBS		Survey		2

¹⁾ ✓ indicates an existing baseline

²⁾ ≡ indicates text data;  indicates vector data;  indicates spreadsheet data (e.g., Excel)

³⁾ Number of checks in the monitoring phase: (1) represents pre- and (2) post-NBS implementation monitoring

^{a)} Providing data with high temporal (hourly) resolution

^{b)} The extent of terraced areas is only partially known as baseline

6.7 Case study #4: Floods in dense urban environments, Dodder Catchment, Dublin, Ireland

This case study illustrates the case of reducing flood risk in dense urban environments using NBS, using the example of the OPERANDUM's OAL in the Dodder Catchment in Dublin, Ireland. The River Dodder is one of the principal rivers in Dublin, it flows from the Dublin Mountains through a number of high-value dense residential areas of Dublin before discharging into the River Liffey estuary at Ringsend (recently named "Silicon Docs" because located where all the headquarters of the Tech Companies are). The River Dodder has a history of flooding and is known as a river which responds quickly to a rainstorm event (Pilla et al., 2019), mostly because of the steep gradient of the river in its upper section. In the last century, it has overflowed its banks on numerous occasions causing damage to adjacent properties: in 1986, when Hurricane Charlie hit Dublin, over 300 properties surrounding the Dodder catchment were flooded (De Bruijn and Brandsma, 2000); in February 2002, a strong high tide occurred and over 600 properties were flooded (Javelle et al., 2002); in October 2011, a similar number of properties were flooded throughout the catchment.

Over the past few decades, Dublin has experienced increasing pressure on land due to population growth, urbanisation and industrialisation. The change in land use and land cover (LULC) patterns in Dublin over the past two decades was assessed performing both supervised as well as unsupervised classification on LANDSAT satellite imagery data, and the effect of LULC change in streamflow simulation was quantified by using a rainfall-runoff model (Basu et al., 2020). Furthermore, a set of indices such as vegetation index, building index, water index and drought index were estimated, and their changes were monitored over time. Soil Water Assessment Tool (SWAT)-based rainfall-runoff models were used to simulate the changes in runoff due to the LULC changes in watershed over two decades. The results indicated an increased rainfall-runoff in Dublin due to the high level of urbanisation, with negative impacts on flood risk in the OAL area. This pressure is going to increase in Dublin as result of climate change in the near future (Gharbia et al., 2016).

The high premium for land in Dublin due to the pressure on house and commercial rental markets is resulting in less available space for the deployment of NBS to mitigate flood risk. After a reiterative co-design approach with high level stakeholders aimed at highlighting local challenges and drivers, and at identifying suitable locations and typologies of interventions, the green roof was selected as the potential NBS. The green roof has high potentials in terms of water retention, and it could be deployed in several locations in a dense urban environment where land has a high premium. Subsequently, rainfall-runoff-based hydrological modelling was performed to assess the potential flood hazard areas and to identify an effective location for implementation of NBS. For this purpose, the hydrological model was simulated with and without the presence of NBS at different potential locations and the site exhibiting highest flood control was selected to be the optimal location. The selected location is in correspondence of the CHQ building and adjacent to River Liffey, which is the main river in Dublin (Sarkar et al., 2020). This intervention in the OAL will also be assessed through quantitative and qualitative comparative analysis to quantify the biophysical and economic values of different NBS alternatives and ecosystem services in Dublin

using two spatially explicit integrated models, Integrated Valuation of Ecosystem Services and Trade-off (InVEST) and Soil Water Assessment Tool (SWAT), to provide valuable data for future policies and replication of the NBS across the city (Sannigrahi et al., 2020).

The green roof will be deployed on a roof area of around 70 m² using modular units. The modular units will be built using exclusively recyclable materials. In order to demonstrate the effectiveness of the green roof NBS, some of the modular units will be left empty without any soil and vegetation: this will allow to assess the performances of the vegetated units in terms of water retention during the pilot time. The assessment will be carried out by instrumenting the green roof with a dense network of sensors. Specifically, the following sensors will be deployed: (1) rain gauges to measure rainfall; (2) sensors to measure wind speed/direction, humidity, temperature, and solar radiation; (3) soil moisture sensors for the piloted modular units; (4) rain gauges to measure the water exiting the modular units; and (5) cameras to visually monitor the green roof and create time-lapse videos for engagement activities. A dashboard with the sensors data and the time-lapse will be displayed on a screen in the CHQ shopping centre to increase the public awareness on the green roof NBS and its potential to reduce flood risk. The concept behind this solution is to bring nature online as the next frontier in ecosystem management with the aim to change the relationship with the natural world in an age of rapid urbanisation and digitisation (Galle et al., 2019).

The framework developed by the OPERANDUM consortium for vulnerability and risk assessment of social-ecological systems (SES) subjected to natural hazards will then be utilised to more comprehensively assess the green roof intervention (Shah et al. 2020), with the aim to provide the City Council with valuable information for future policies and thus foster the replication of the NBS piloted in the OAL in Dublin. The detailed smart green roof approach will then be replicated on other public buildings owned by Dublin City Council to further mitigate flood risk in the dense urban environment of Dublin city.

Finally, the OAL activities related to the assessment and wider deployment of the green roof NBS include the spatial reconfiguration and optimisation of the dense network of rainfall sensors (over 50) in the Dublin area. This is done with the support of Dublin City Council who provided access to the sensors. The statistical models used for this task replicate and expand the work detailed in Basu et al. (2019), which allows the identification of redundant rain gauges and influential ungauged locations in the Greater Dublin area based on hourly and daily rainfall data by considering covariance factor, kriging, Shannon entropy and annealing approaches. The data from the optimised network of rain gauges will be then used, in conjunction with the measurements from the river level sensors, to generate Artificial Intelligence forecasting models for river levels, which will allow to alert the Council of potential flood events according to different weathers, replicating an approach used previously in another Irish catchment (Assem et al., 2017).

6.8 Concluding Remarks

Effective disaster risk reduction strategies require a combination of several techniques, and implementation of structural and non-structural measures. Choosing the optimal strategy is a key objective for local authorities and infrastructure managers.

NBS can be considered as structural measures with sometimes limited capacity (for mitigating the impacts of extreme events, for example) but also with additional co-benefits in comparison with classical grey measures. Needless to say, no solution can be universal and work in all situations. NBS may exhibit some drawbacks: during extreme floods, riparian forests supply woody debris which worsen the risk level. Most of time, a hybrid combination of green and grey measures will provide the optimal solution when DRR is the main goal (e.g., riparian buffers and a rack to trap large debris just upstream sensitive bridges). NBS assessment requires consideration of several criteria and combined methods. Assessment frameworks based on classical deterministic approaches cannot be used alone anymore. Other frameworks such as decision-aiding methods and systemic analysis offer new opportunities and methodologies. A paradigm shift in DRR engineering is probably emerging through the recent NBS projects (see Tacnet et al., 2019).

To assess the effectiveness of any measure, the analyst must identify its function, the required capacity of the measure being assessed and a measurable indicator for evaluating this capacity. Classical indicators used for risk assessment can be employed for this purpose. The case studies provided here are only partial examples and should be considered more as non-exclusive methodological pathways to characterize NBS effectiveness. The fact that NBSs are effective for mitigation of the impacts of extreme events has still to be demonstrated. To mitigate the risk of extreme natural hazard events, classical civil engineered techniques and hybrid solutions may be the optimal measures in the foreseeable future.

Finally, a DRR strategy based on NBS faces the same large challenges linked to any DRR strategy, including multi-risk situations, global change effects and uncertainties.

6.9 References

- Alves, A., Gersonius, B., Kapelan, Z., Vojinovic, Z., and Sánchez, A., 'Assessing the Co-Benefits of green-blue-grey infrastructure for sustainable urban flood risk management', *Journal of Environmental Management*, Vol. 239, 2019, pp. 244–254.
- Alves, A., Vojinovic, Z., Kapelan, Z., Sánchez, A., and Gersonius, B., 'Exploring trade-offs among the multiple benefits of green-blue-grey infrastructure for urban flood mitigation', *Science of the Total Environment*, Vol. 703, 2020.
- Arfaoui, N. and Gnonlonfin, A., *Testing Meta-Regression Analysis in the context of NBS restoration measures: The case of Brague River*, Working Paper ESDES n°2020-02, 2020a. Available from: https://www.esdes.fr/wp-content/uploads/sites/12/2020/11/wp_esdes_2020_02_arfaoui_gnonlonfin.pdf

- Arfaoui, N., and Gnonlonfin, A., 'Supporting NBS restoration measures: A test of VBN theory in the Brague catchment', *Economics Bulletin*, Vol. 40, No 2, 2020b, pp. 1272–1280.
- Assem, H., Ghariba, S., Makrai, G., Johnston, P., Gill, L. and Pilla, F., 'Urban water flow and water level prediction based on deep learning', In: *Joint European Conference on Machine Learning and Knowledge Discovery in Databases*, 2017, pp. 317-329.
- Basu, B., Sarkar, A., and Pilla, F. 'Identification of optimal number of rain gauges and their locations based on different statistical approaches: A case study in Dublin based on hourly and daily rainfall data', *Geophysical Research Abstracts*, 2019.
- Basu, B., Sarkar Basu, A., Sannigrahi, S., and Pilla, F., 'Investigating land use and land cover changes in Dublin, Ireland using Satellite Imagery: A comparative analysis', In: *EGU General Assembly 2020*, Online, 4–8 May, 2020.
- Bokhove, O., Kelmanson, M.A., Kent, T., Piton, G., and Tacnet, J.-M., 'Communicating (nature-based) flood-mitigation schemes using flood-excess volume', *River Research and Applications*, Vol. 35, 2019, pp. 1402–1414.
- Bokhove, O., Kelmanson, M.A., Kent, T., Piton, G., and Tacnet, J.-M., 'A Cost-Effectiveness Protocol for Flood-Mitigation Plans Based on Leeds' Boxing Day 2015 Floods', *Water*, Vol. 12, 2020, pp. 1–30.
- De Bruijn, E., and Brandsma, T., 'Rainfall prediction for a flooding event in Ireland caused by the remnants of hurricane Charley', *Journal of Hydrology*, Vol. 239, 2000, pp. 148–161.
- Evette, A., Labonne, S., Rey, F., Liebault, F., Jancke, O., and Girel, J., 'History of Bioengineering Techniques for Erosion Control in Rivers in Western Europe', *Environmental Management*, Vol. 43, 2009, pp. 972–984.
- Galle, N.J., Nitoslawski, S.A., and Pilla, F., 'The Internet of Nature: How taking nature online can shape urban ecosystems', *The Anthropocene Review*, Vol. 6, No 3, 2019, pp. 279–287.
- Gharbia, S.S., Gill, L., Johnston, P., and Pilla, F., 'Multi-GCM ensembles performance for climate projection on a GIS platform', *Modeling Earth Systems and Environment*, Vol. 2, No 2, 2016, p. 102.
- Hellmers, S., Ackermann, D., Einfalt, T., and Fröhle, P., 'Konzeptstudie zur Steuerung von wasserwirtschaftlichen Anlagen auf der Grundlage von Ensemble Kurzzeitvorhersagedaten', In: *Tag der Hydrologie*, Trier, Germany, 2017.
- Javelle, P., Ouarda, T.B., Lang, M., Bobée, B., Galéa, G., and Grésillon, J.-M., 'Development of regional flood-duration–frequency curves based on the index-flood method', *Journal of Hydrology*, Vol. 258, 2002, pp. 249–259.
- Pengal, P., Pagano, A., Piton, G., Kozinc, Z., Cokan, B., Šinkovec, Z., and Giordano, R., 'Chapter 16: Glinščica for all: exploring the potential of NBS in Slovenia: barriers and opportunities', In: *WaterSecurity in a New World*, Springer, 2020.
- Pilla, F., Gharbia, S.S., and Lyons, R., 'How do households perceive flood-risk? The impact of flooding on the cost of accommodation in Dublin, Ireland', *Science of The Total Environment*, Vol. 650, 2019, pp.144–154.
- Rinaldi, M., Surian, N., Comiti, F., and Bussetini, M., 'A method for the assessment and analysis of the hydromorphological condition of Italian streams: The Morphological Quality Index (MQI)', *Geomorphology*, Vol. 180–181, 2013, pp. 96–108.
- Sannigrahi, S., Basu, B., Sarkar Basu, A., and Pilla, F., 'Ecosystem service-based approach for evaluating the effectiveness of nature-based solution in mitigating climate change and land degradation issues in a city region', *EGU General Assembly 2020*, Online, 4–8 May, 2020.
- Sarkar Basu, A., Basu, B., Sannigrahi, S., and Pilla, F., 'Deployment of Green roof top as a Nature Based Solution in Dublin, Ireland', *EGU General Assembly 2020*, Online, 4–8 May, 2020.
- Shah, M.A.R., Renaud, F.G., Wild, A., Anderson, C.C., Loupis, M., Panga, D., and Sabatino, S.D., 'A conceptual framework for vulnerability and risk assessment in the context of nature-based solutions to hydro-meteorological risks', *EGU General Assembly 2020*, Online, 4–8 May, 2020.
- Tacnet, J.-M., Piton, G., Philippe, F., Gourhand, A., and Vassas, C., 'Décider dans le contexte de la GEMAPI : exemple de méthodologie d'une approche intégrée d'aide à la décision et application aux projets d'aménagements', *Science Eaux and Territoires*, Vol. 26, 2018, pp. 48–53.
- Tacnet, J.-M., Piton, G., Favier, P., Pengal, P., *DELIVERABLE 5.4 Integrative modelling framework and testing in the DEMOS. Part 4: From indicators definition to NBS choice and effectiveness assessment*, EU Horizon 2020 NAIAD Project, Grant Agreement N°730497, 2019.

- Turconi, L., Faccini, F., Marchese, A., Paliaga, G., Casazza, M., Vojinovic, Z., and Luino, F., 'Implementation of nature-based solutions for hydro-meteorological risk reduction in small Mediterranean catchments: The case of Portofino natural regional park, Italy', *Sustainability*, Vol. 12, No 3, 2020, p. 1240.
- Watkin, J. L., Ruangpan, L., Vojinovic, Z., Weesakul, S., and Torres, S.A. (2019). 'A Framework for Assessing Benefits of Implemented Nature-Based Solutions', *Sustainability*, Vol. 11, No 23, 2019, p. 6788.

MAES

Mapping and Assessment of Ecosystems and their Services Urban pilot and EU ecosystem assessment

EU GB

Action 5 of the Strategy, better known as Mapping and Assessment of Ecosystems and their Services (MAES), states 'Member States, with the assistance of the Commission, to map and assess the state of ecosystems and their services in their national territory, assess the economic value of such services, and promote the integration of these values into accounting and reporting systems at EU and national level by 2020'. MAES provided guidance to EU countries on ecosystem assessment through a series of thematic pilots including urban ecosystems. It also delivered a EU ecosystem assessment which provides an analysis of trends in pressures, condition and services of marine, freshwater and land ecosystems of the EU+GB using 2010 as baseline year. Urban ecosystems cover about 5% of the EU land area but their immediate impact stretches well beyond their boundaries. Therefore, the system of functional urban areas, which cover 22.5% of the EU land area, was used in the assessment to analyse trends in pressure and condition.

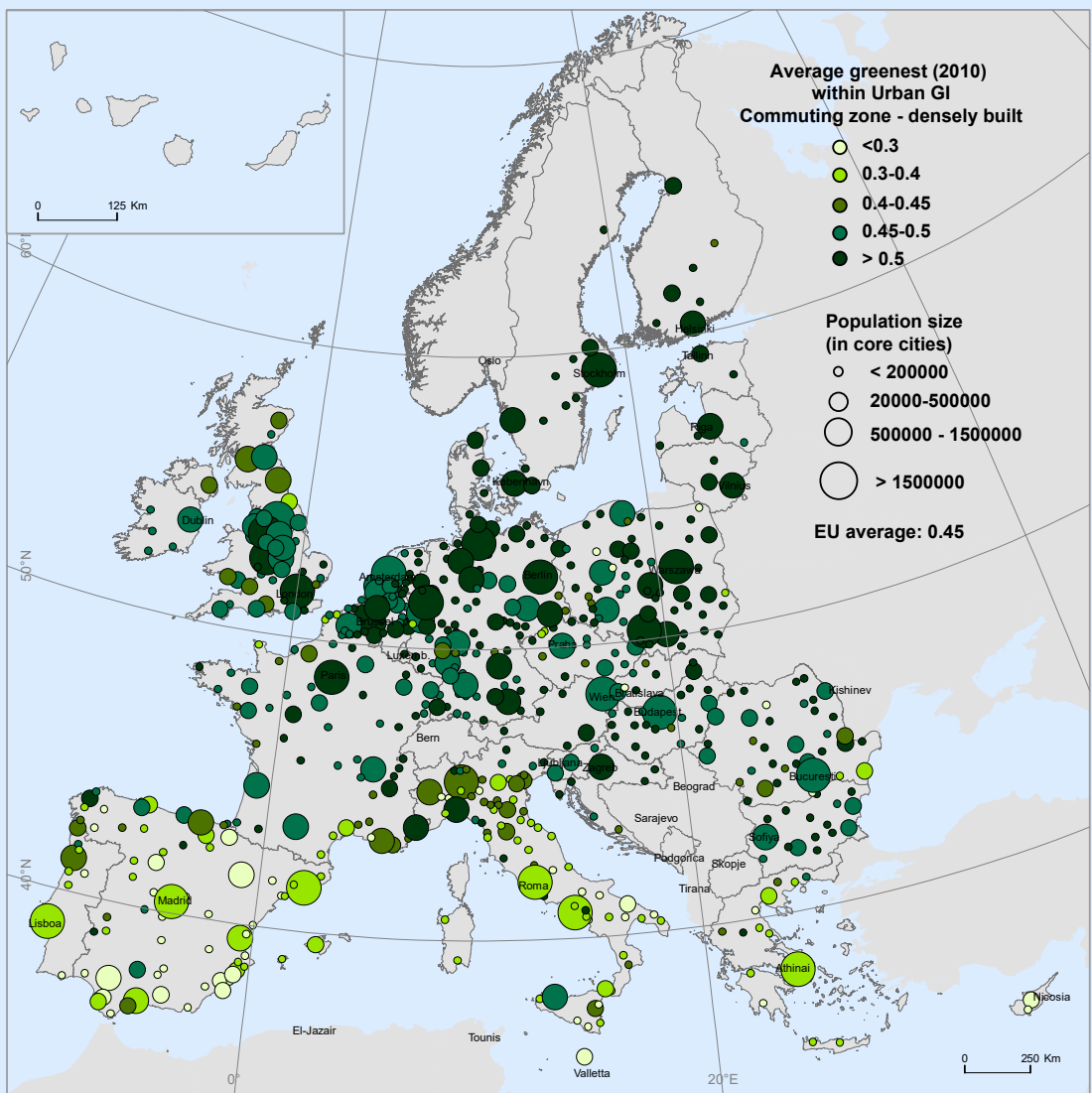

Drawing on knowledge from projects funded by the European Union

Figure: Average greenest (2010) within Urban Green Infrastructure - Maes, J. et al. 2020

Approach to Impact Assessment

Urban ecosystems, cities and their surroundings were assessed using the functional urban areas implementing the MAES framework to assess ecosystems pressures and condition. Indicators are spatially explicit and were implemented in a consistent and comparable way.

Involved Stakeholders and roles

The MAES initiative is a collaboration between three key stakeholder groups:

- the member states, represented by national environmental authorities;
- EU services including DG Environment, DG Research and Innovation, the Joint Research Centre, and the European Environment Agency;
- scientists and experts who participate to the working group or who contributed to pilots and case studies.

Nationale environmental authorities

EU level stakeholders

Scientists / Academia

Lessons learned

Growing cities can minimise their impacts through nature-based solutions. These solutions span from the conservation of natural ecosystems within commuting zones to the restoration, creation and management of multifunctional green urban areas in order to improve local climate, reduce urban overheating, mitigate flooding, air pollution and biodiversity loss. The design and management of new urban nature in the core area of cities can also provide opportunities for recreation and social interaction, and significantly improve urban quality of life.

Main Challenges addressed

1. Climate Resilience

2. Water Management

3. Natural and Climate Hazards

4. Green Space Management

5. Biodiversity

6. Air Quality

7. Place Regeneration

8. Knowledge and Social Capacity Building

9. Participatory Planning and Governance

10. Social Justice and Social Cohesion

11. Health and Wellbeing

12. New Economic Opportunities & Green Jobs

**Learn more
on the project website**

**Learn more
in the final Report**

Maes, J. et al. Mapping and Assessment of Ecosystems and their Services: An EU ecosystem assessment, EUR 30161 EN, Publications Office of the European Union, Luxembourg, 2020, ISBN 978-92-76-17833-0 (online),978-92-76-22954-4 (supplement), doi:10.2760/757183 (online),10.2760/519233 (supplement), JRC120383.



EnRoute

Enhancing Resilience of Urban Ecosystems through Green Infrastructure

Antwerp (BE) Dublin (IE) Glasgow (GB) Helsinki (FI) Karlovo (BG) Leipzig (DE)

Lisbon (PT) Manchester (GB) Oslo (NO) Poznan (PL) Padova (IT) Rome (IT)

Tallinn (EE) The Hague (NL) Trento (IT) Utrecht (NL) Valletta (MT)

EnRoute is a project of the European Commission in the framework of the EU Biodiversity Strategy and the Green Infrastructure Strategy. EnRoute provides scientific knowledge of how urban ecosystems can support urban planning at different stages of policy and for various spatial scales and how to help policy-making for sustainable cities.



Drawing on knowledge from projects funded by the European Union

Approach to Impact Assessment

EnRoute (2017-2019) was an Administrative Agreement between DG Environment and the JRC, with a view to implement a European Parliament Pilot Project on Urban Green Infrastructure. This Pilot Project aimed at building further on the many positive experiences of the MAES urban pilot, for which the JRC has been a central partner. It will further help promoting the application of GI at local level and will deliver guidance on the creation, management and governance of GI, e.g. through the development of relevant indicators to map and assess GI in urban contexts, and testing them in additional cities. The approach was built on three lines of focus: (1) Networking and improving flows of knowledge and information, (2) Citylabs: Testing the urban GI MAES framework in cities across Europe. (3) Better understanding of positive interactions and mutual reinforcement between urban GI policies and objectives at different governance levels. EnRoute also contributed to the impact evaluation framework for nature-based solutions (EKLIPSE project) and provides tools and protocols for measuring the impact of urban nature-based solutions.

Involved Stakeholders and roles

18 city-labs were involved. A research institute and the municipality were involved. City-labs implemented the MAES approach to assess urban ecosystems and urban GI, focusing on challenges discussed with the local authorities.

Municipal Administrations

Scientists / Academia

Lessons learned

Urban Green Infrastructure (UGI) refers to the strategically managed network of urban green spaces and natural and semi-natural ecosystems situated within the boundary of an urban ecosystem. These high-quality, biodiversity-rich areas can help make cities more sustainable and contribute to solve many challenges, such as air pollution, noise, climate change impacts, heat waves, floods and public health concerns. As cities grow and develop, it is vital to improve the availability, quality and accessibility of UGI. Urban planners and decision-makers across Europe are increasingly seeking to integrate UGI, ecosystem services and nature-based solutions into their urban planning processes, but these efforts must

Main Challenges addressed

1. Climate Resilience
2. Water Management
3. Natural and Climate Hazards
4. Green Space Management
5. Biodiversity
6. Air Quality
7. Place Regeneration
8. Knowledge and Social Capacity Building
9. Participatory Planning and Governance
10. Social Justice and Social Cohesion
11. Health and Wellbeing
12. New Economic Opportunities & Green Jobs

be scaled-up further if we are to create more resilient, sustainable and 'livable' cities for future generations. This project provided knowledge on how UGI can support urban policy-objectives at different stages of the planning process and at a variety of spatial scales.

The proposed framework is useful for

- Making a case at local level
- Compare the performance of cities
- Raising awareness about the multiple functionality of ecosystems
- Enhancing cross-sector cooperation or co-operation across different political levels

EnRoute:

- Provided inspiration at national and local level
- Provides a framework that can be adapted to fit local needs
- Helped build communities of practice across sectors
- Provided diverse set of examples/city-labs gives inspiration

Learn more
<https://oppla.eu/groups/enroute>



07

What kinds of NBS monitoring data can I gather, and how should I manage these data?

Main data types, data sources and data generation techniques

Data gaps, biases and ways to address them

Why is it important to evaluate the impacts of NBS?

What constitutes NBS monitoring?

How do I develop a robust NBS monitoring plan?

How can I execute monitoring and impact assessment activities?

What indicators of NBS impact can I use?

How do I select appropriate indicators of NBS impact?

How can I ensure NBS work for Disaster Risk Reduction?

7 DATA REQUIREMENTS

Coordinating Lead author

Leo, L.S.

Lead authors

Kalas, M., Leo, L.S.

Contributing authors

Baldacchini, C., Budau, O.E., Castellar, J., Comas, J., Connop, S., Corbane, C., Decker, S., Draghia, M., Dubovik, M., Dushkova, D., Haase, D., Ivits, E., Körmöndi, B., Kumar, P., Laikari, A., Leopa, S., Littkopf, A., Ommer, J., Rinta-Hiiro, V., Spano, G., Spinnato, P., Vranić, S., Teixeira da Silva, R., Zavarrone E.

Summary

What is this chapter about?

Chapter 7 offers an overview of the main types of data, data sources, and data generation techniques for NBS monitoring and impact assessment. After familiarising you with common data terminology and definitions (Section 7.1), we review the types of data associated with NBS monitoring and assessment (Sections 7.2–7.7), their use for indicator assessment (Section 7.8) and baseline construction (Section 7.9), and the principal aspects determining the quality of analysis (Section 7.10). Concepts are illustrated through examples and complemented with potential data sources. Finally, we reflect on data sharing,

data exchange, data management and dissemination of data gathered (Section 7.11).

How can I use this chapter in my work with NBS?

This chapter aids to understand the data requirements for evaluating NBS performance and impact. This chapter:

- 1) Provides knowledge regarding available data sources;
- 2) Assists in developing a robust plan for the collection, management and use of data;
- 3) Offers examples of how data have been collected and integrated by various EU Horizon 2020 projects; and,
- 4) Raises awareness of the challenges commonly encountered such as data gaps, data availability, data reliability and related potential error sources.

When should I use this knowledge in my work with NBS?

The knowledge provided in this chapter can be used in the planning phase of NBS projects in order to assess whether the required datasets can be obtained from external data sources or should be generated within the project. In the latter case, Chapter 7 provides guidance towards data generation/integration (e.g., modelling, measurement campaigns). This chapter also supports the development of standardised data management protocols for effective data sharing and data dissemination.

How does this chapter link with the other parts of the handbook?

Chapter 7 supports the development and execution of a robust monitoring and evaluation plan (Chapters 2 and 3), by detailing considerations related to data types, data integration, and the adequacy of data for indicator assessment and baseline construction. This chapter describes the data requirements for computing NBS indicators (Chapters 4-6 and Appendix of Methods).

Evaluating NBS benefits, co-benefits, and trade-offs can be a data intensive process. Understanding the data requirements is a critical element in relation to ensuring both the efficacy and cost-effectiveness of this evaluation process. In order to establish the monitoring plans and schemes described in previous chapters, and to deliver this over the range of relevant scales, it is therefore critical to generate data that are both applicable for the nature-based solution impact assessment, and that are comparable to the preceding monitoring campaigns. This chapter addresses the data requirements involved in evaluating the impacts that nature-based solutions manifest and explains the data building blocks involved in NBS monitoring and assessment procedures.

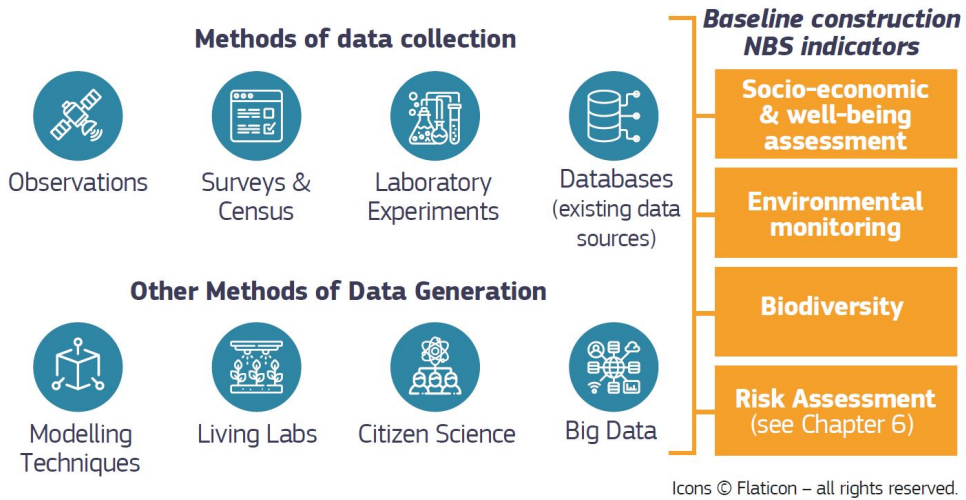

Figure 7-A. How can we generate data for NBS monitoring and evaluation?

7.1 Data terminology, definitions and key concepts

Data requirements for NBS monitoring and assessment span multiple and diverse data types and sources, and thus involve techniques, methods and concepts drawn from various disciplines of both natural and social sciences. This section provides the reader with a basic knowledge of the terminology and concepts commonly encountered when dealing with data requirements for the NBS evaluation process. It also contains explanations of the main data types and data aspects relevant for NBS assessment and thus aids the reader in navigating the rest of this chapter.

7.1.1 Spatial versus non-spatial data

Spatial data is a term used to describe data containing information about a specific location on the Earth's surface. Spatial data are essential for any mapping activity as they provide information on the exact location, shape, size, and orientation of a given entity (e.g., a river). Non-spatial data, on the contrary, contain information which is independent from any geometric and/or topological consideration (e.g., street names). Non-spatial data are also termed attributes as they are usually combined with spatial data to provide additional information on the specific geographic entities identified by a spatial dataset. For example, the geometric characteristics of a city district (spatial data) can be combined with information on air quality (non-spatial data) and displayed together on a map using a legend of colours, with each colour indicating a certain level of air pollution.

Spatial data are stored in spatial databases that are optimized for storing and querying data that represent objects defined in a geometric space. Depending on the way they are manipulated and stored, spatial data can be of two types: vector and raster. In vector form, spatial data are represented in form of points (e.g., the location of individual trees in a city), segments (e.g., the path of a river in the same city) and polygons (e.g., houses and urban green parks). In the simplest form of a raster, spatial data are represented as a matrix of cells (or pixels) organized into rows and columns (a grid) where each cell contains a value representing information (such as elevation, temperature, number of people). Satellite images, such as land cover/land use maps, are typical examples of raster spatial data. Manipulation, storage, and visualization of digital spatial and non-spatial datasets are commonly done using GIS (Geographic Information Systems) software like ArcGIS. Examples of spatial and non-spatial data of relevance for NBS monitoring are given in Section 7.8.

7.1.2 *Baseline data*

As defined by EUROSTAT, a baseline study is “an analysis of the current situation to identify the starting points for a programme or project. It looks at what information must be considered and analysed to establish a baseline or starting point, the benchmark against which future progress can be assessed or comparisons made.” (EUROSTAT, 2014). In the context of NBS, the establishment of a baseline involves collecting a set of data that allows the description of the geo-morphological, socioeconomic conditions, living standards and livelihoods of NBS project-affected communities and their potential hosts prior to any NBS intervention. Those data will be used as a reference for monitoring the impacts of the NBS on the involved territories, thus allowing a

Data can take a variety of different forms and types depending on how it is generated. Here we explore this different types with a view to informing how they might contribute to an evaluation approach.

comparison between the pre-project implementation state of play and the post-project implementation situation. The results of this monitoring process are the starting point not for the comparison between the changes occurred due to NBS interventions and other grey or hybrid solutions addressing the same issue, but for the assessments of the benefits

attributable to NBS. Baseline data collection and requirements are the topic of Section 7.9.

7.1.3 *Control data*

Impact evaluation mostly addresses the cause-and-effect questions and different methods can be used to establish what the causal effect (impact) of an NBS intervention on an outcome of interest is. These methods should estimate the so-called counter-factual: is a given NBS intervention effective compared to the

absence of the intervention or to alternative, traditional engineering or planning solution? Control data are generally collected to assess counter-factual, and they consist in collecting the same variables, with the same methodology, as per the NBS intervention site, in a suitable, different site. Depending on the outcome to be evaluated, control data collection would need the identification of a suitable control area or control group. Further details on this aspect can be found in Chapters 2 and 3 of this Handbook.

7.1.4 Acquisition regime

Acquisition regime refers to the temporal interval over which a certain variable (e.g., temperature) or process is monitored. Typically, the timestamp assigned to a data point can refer to discrete observation/model time (which represents the sampling frequency) or the beginning or the end of the observation/aggregation time interval. Following the INSPIRE Directive (EC, 2007), acquisition regime can be distinguished into:

- Continuous data acquisition (Data are generated on a continuous basis)
- Demand driven data (Data are generated on demand)
- Once-off data (Data are generated only once in this configuration. No further observations in this configuration can be expected)
- Periodic data collection (Data are generated at regular intervals)

For example, relevant indicators such as residential property sale and rent value in the areas of future NBS implementation, can be solely available as once-off data. On the contrary, many of the datasets employed for baseline conditions characterisation (cf. Section 7.9) are typically retrieved from national statistics organisations or local municipalities, thus they have varying periodicity: at national level they are usually collected with a yearly periodicity, while at neighbourhood level, data collection is only done during national censuses, which are conducted every 5 to 10 years.

In many cases, data for the computation of NBS environmental indicators are acquired continuously, either as part of permanent monitoring networks established by environmental agencies and research institutions or as ad-hoc monitoring campaigns carried out within NBS projects. In the EU-H2020 project UNaLab, for example, continuous data collection has been used for quantifying physicochemical indicators, such as discharge and water quality, as well as for other environmental constituents (e.g., temperature, precipitation, and air quality).

In general, the choice of a certain acquisition regime over another should be dictated by (and lower than) the expected temporal dynamics of the process or variable under scrutiny. In practice, however, it is often a compromise between several factors, such as technological feasibility, project duration, resources, and funding availability. This means that adequate acquisition regimes should be

carefully assessed to avoid data gaps, poor data adequacy (cf. Section 7.10), and limited data availability in the computation of NBS performance indicators as well as the establishment of a baseline.

7.1.5 Spatial scale of analysis

Spatial domain is another critical factor affecting data representativeness and adequacy. Data requirements in terms of spatial domain depends on a combination of (1) the scale of nature-based solution intervention (large vs. small scale NBS), and (2) the expected scale of the impact for each indicator being evaluated (some datasets are representative of small-scale processes while others provide impact at broader scales). This means that NBS evaluation indicators need to be assessed over the proper spatial scales. Those can be identified with the aid of other types of indicators which have been created with the specific purpose of measuring the spatial scale of NBS impacts (for example, the spatial extent of cooling effect in relation to reduced air temperature).

Thus, scale classification in terms of data requirements may include:

- Landscape or regional scale
- City scale
- Neighbourhood scale
- Street or pedestrian scale
- Nature-based solution footprint scale

The typical NBS scales involved are relatively small, namely data requirements are usually at the neighbourhood scale, the street or pedestrian level, and the NBS footprint scale. Nevertheless, datasets at larger scales become important when assessing the upscaling and replication potential of individual NBS interventions at city scale or at landscape/watershed scale (as in the case of NBS for disaster risk reduction – cf. Chapter 6) and, in that respect, they allow to establish robust baselines to guide planning and city-wide interventions.

An example is the series of NBS eco-gardens being implemented in kindergartens across the city of Poznan in the framework of the EU-H2020 project Connecting Nature. In terms of scales, the transition from hard impermeable surfaces, like asphalt, to vegetated surfaces, is expected to positively impact the thermal comfort at the scale of the kindergarten footprint. However, if a critical mass of nature-based solutions can be rolled out across the city in future, through the implementation of eco-gardens in social spaces and other mechanisms, it might be worth considering also the establishment of a baseline for thermal comfort at greater regional/administrative scale, so that changes compared to the baseline can be quantified in future.

For ease of comparison between indicators within a location, for ease of comparison of an indicator between cities, and in relation to exploiting data sources that are already collected, using standardised spatial scales can be beneficial. For example, Nomenclature of Territorial Units for Statistics (NUTS) spatial scales for indicator evaluation can provide a standardised scale (EUROSTAT, 2020). NUTS represent a geocode standard, developed and regulated by the European Union, for referencing the subdivisions of countries for statistical purposes. For EU member countries, a hierarchy of three NUTS levels was established, corresponding to increasing granularity of districts. Whilst not always corresponding to administrative divisions within a country, the NUTS spatial scales correspond with standardised data gathering and reporting that can be a useful data source for evaluation indicators, particularly those associated with economic evaluation. It is, however, important to note that NUTS scales will not be relevant for all expected spatial scales of impact.

7.1.6 Processing level

From a data processing perspective, the computation of a given NBS indicator consists of using existing data to create new types of data through some sort of transformation, such as an arithmetic formula or aggregation (e.g., spatial/temporal interpolation). Various degrees of data integration and manipulation are possible, which means that basic indicators can be used as input data for the computation of more sophisticated or synthetic indicators. In that respect, a straight indicator hierarchy has been recently proposed within the EU-H2020 Project Nature4Cities. This hierarchy classifies the indicators into three levels of processing (Figure 7-1). A **1st level indicator** is a value derived from a dataset, which describes the state of a phenomenon or the environment. If a 1st level indicator is introduced into an equation or model, it gets into the next level which is the **2nd level indicator**. If this one is used again in an equation or model, then it is a **3rd level indicator**. For each new level, assumptions are made and accumulated, and simplification or loss of quality may result.

INDICATOR DEFINITION AND HIERARCHY		EXAMPLES
1st LEVEL INDICATOR	A value derived from a specific dataset, which points to provide information about, and/or describes the state of a phenomenon/environment/area	MRT (Mean Radiant Temperature)
2nd LEVEL INDICATOR	1st level indicator proceeded into further equation or model	PET (Physiological Equivalent Temperature)
3rd LEVEL INDICATOR	2nd level indicator proceeded into further equation or model	PET Thermal Sensation Scale

Figure 7-1. Indicator Hierarchy adopted in the EU-H2020 project Nature4Cities.

Depending on the specific indicator and the temporal and spatial scales under consideration, some 1st, 2nd or even 3rd level indicators can be readily available from external data sources (e.g., national statistics organisations and environmental agencies). In most cases, however, the computation of NBS

performance indicators entails the acquisition of the required datasets. These datasets can be retrieved from external databases (when available) or newly generated by conducting ad-hoc measurement campaigns and/or numerical modelling efforts (cf. Sections 7.2–7.6). In both cases, it is important to recognize that data themselves undergo different level of processing before becoming directly usable by non-technical experts. For example, satellite data such as Sentinel products are systematically provided at various processing levels.

In general, there are three levels of processing commonly encountered with any type of dataset:

- **Raw data**, namely data directly outputted by a measuring device or a numerical model (or any other data acquisition technique), with no (or minimal) data validation/verification, manipulation, or conversion into standard units and/or formats. These data are rarely usable by non-expert users.
- **Quality controlled data**, namely data which have been screened for outliers and other possible error conditions. Data points identified as problematic and erroneous are removed or flagged.
- **Final data products**, namely data which have been quality checked and have undergone various post-processing procedures to be converted into more useful parameters and data formats.

7.1.7 Data Generation and Collection Methods

Data collection should be based on solid planning, technical expertise, and a wide knowledge of the state of the environment and its functioning in relation to humans in order to ensure that the relevant and accurate data are garnered properly for the purpose of NBS monitoring and assessment. In general, data collection methods (also referred to as acquisition mode) used for NBS monitoring and assessment include a few standard ways of collecting data: (a) Observations, (b) Surveys and Census, (c) Laboratory Experiments.

Observations can be regarded as one of the main methods for monitoring the performance of NBS interventions and their impact on the socio-ecological system. This includes manual or automated collection of quantitative information (namely **direct measurements**, e.g., measurement of temperature) or can be defined as a detailed examination by watching, noticing or hearing (Kawulich, 2012) in case of qualitative information. Differently from survey, the observer does not influence the study in any way or attempt to intervene in it. As such, one of its advantage is the objectivity. In the rest of this chapter, observational data are differentiated into population observations and environmental observations due to their different techniques in data acquisition. For example, satellite and ground sensor observations are primarily used for environmental monitoring and further discussed in Sections 7.2.1 and 7.2.2, respectively.

On the other hand, people's behaviour and attitude towards NBS interventions can be also observed by other humans without direct interaction as explained in Section 7.3.2. Population observations function as an umbrella for different methods of collecting data on people's behaviour, attitudes, and, especially, their interaction with each other but also with nature. These methods have been increasingly used for monitoring social benefits of NBS. In this context, observations can be either quantitative (e.g., number of people visiting an NBS) or qualitative (e.g., how people interact with nature or an NBS).

Surveys and **Census** represent another important method of collecting environmental, socio-demographic and economic data and statistics for NBS assessment. An important source of survey data for NBS are administrative records, namely administrative data stored by the governments and other organizations such as annual reports on the state of environment, etc.

Differently from observations, surveys represent a research strategy to collect information in interaction with people (Ponto, 2015). Survey data are collected by having participants (sample group or population) responding to quantitative and/or qualitative questions. The responses of the sample group are statistically analysed and can be used as representative, under specified conditions, of a whole and for comparison. Census data differ from (quantitative) survey data only in terms of completeness and for temporal slices. Indeed, while survey data are based on a population sample, census data are universal by considering every individual. In regard to NBS, survey data can be used for defining a baseline and for further monitoring of socio-economic and health benefits and impacts. Section 7.3.1 addresses survey data in more detail.

It should, however, be noticed that the term survey is also frequently used in the context of environmental monitoring, mainly to indicate data collection methods which require sampling (e.g., removal of the soil) of the object of investigation. This type of survey is for example used to monitor biodiversity at the NBS site (cf. Section 7.2.3).

Laboratory Experiments are useful when the researchers intend to control the results of the study always in a cause and effect pattern (Sullivan et al., 2016). Differently from observational studies which randomly select a sample and may find correlations between variables (Rosenbaum, 2010), laboratory studies can control or manipulate some or all variables that might affect the phenomenon under study and thus identify and confirm the potential mechanisms underlying observed responses (Montgomery, 2008). In the context of NBS, laboratory studies can help assessing either people behaviour towards NBS or the environmental performances of different NBS. In either application, laboratory data could be particularly valuable when used as pilot studies and/or at the planning phase of an NBS intervention, as discussed in Section 7.6.

Data collected through the aforementioned methods are typically complemented by data generated through modelling approaches. **Numerical simulations** and **modelling** refer to a fundamental part of the methodologies used in NBS monitoring and will be discussed in Section 7.5. Modelling is a process of abstraction and generalization aimed at developing adequate models (representations) of the real-world systems to be examined (Grützner, 1996).

The models developed for data simulation purposes can be classified as simplified (non-physics-based) model and numerical models (although other categories and classifications exist). Simplified conceptual models are a representation of physical processes and require significantly less computer effort than the numerical models. They are particularly appropriate to simulate datasets for large study areas and/or stochastic modelling for probabilistic based risk assessment (including elements of randomness, e.g., probability distributions and generalised linear models) and multi-scenario modelling on a bigger scale with availability of quality observational datasets. Numerical models are mathematical equations that attempt to simulate a state variable by solving equations developed by applying laws of physics and typically require solving them computationally. Therefore, the numerical models are developed to represent/simulate detailed state variables (e.g., temperature, precipitation) dynamics. Depending on their spatial representation of the problems in hand, the models use lumped (variables of interest are a function of time only) or spatially distributed approach and can be dimensionally classified into one-dimensional (1D), two-dimensional (2D) and three-dimensional (3D) models.

Citizen Science is a research focus that enables citizens and stakeholders to be actively engaged in science data generation and monitoring programs. It refers to *"the general public engagement in scientific research activities when citizens actively contribute to science either with their intellectual effort or surrounding knowledge or with their tools and resources"* (Serrano et al., 2014). The European Environment Agency define three types of citizen science activities based on the degree of citizen involvement: 1. *contributory* – meaning that citizens are involved in data collection; 2. *collaborative* - participants are involved in more than data collection such as in data analysis, project design, and results dissemination; and 3. *co-created* – where citizens are involved in basically every aspect of work. Citizen science opens new possibilities for data collection and analysis, introduces different perspectives and cooperation, but also offers various benefits for the community itself, such as public engagement, awareness raising, and lifelong learning opportunities in science (Hecker et al., 2018). In terms of data generation, citizen science can generate a range of different data types. This approach is primarily used for environmental monitoring, but there are also examples of social and economic applications. Citizen Science has also been increasingly used in NBS context. This will be discussed in Section 7.7.

Another emerging approach is **Big Data**. The term indicates data which are characterized by large variability, volume and variety, among other aspects. Big data can be considered as an evolution of "data mining", which refers to the development of datasets which are very large and can be identified with statistical significance (Sang, 2020). Data mining means searching for valuable information in a large database. Deploying data mining methods requires a type of expertise which is increasingly in demand, but this expertise is not domain-specific. It can be deployed where scientific theory has no more intelligent solution to offer (Sang, 2020). Despite the several pitfalls hidden into it, the use of big data could be key in the perspective of achieving a more solid and wide-ranging evidence of NBS impacts through on-going and future efforts in collaboratively and collectively preserving, organizing and sharing NBS related data (Hampton et al., 2013; see also Section 7.10.4). Examples on the use Big Data for NBS assessment are provided in, e.g., Section 7.8.

7.2 Environmental data of relevance for NBS monitoring and assessment

In Section 7.1.7, observational data were differentiated into *environmental* and *population* observations and a brief definition of both was provided. This section focuses on environmental data. A wide variety of approaches has been developed to observe environmental and ecological impact of NBS, taking experience from the previous background of the research community in these fields (Houghton et al., 2012; Lein, 2012). In fact, this represents one of the most established areas of nature-based solution evaluation.

A diversity of methods has been implemented that cover a broad range of the potential benefits, and trade-offs, associated with nature-based solution implementation. In terms of data types, there are two categories of environmental observations which are essential and widely used to assess and monitor the physical or environmental conditions of a NBS site and to establish a baseline: remote sensed data and in-situ observations and measurements. In some cases, these observations are also complemented by survey data gathered at the NBS site or available from national databases.

These measurement techniques allow to gather a large variety of environmental data. In that respect, the concept of “essential climate variables” (ECVs), might be useful (WMO, 2020). The concept of Climate Essential Variables was first used for the development of the Global Climate Observing System. The essential climate variables (ECVs) are formally defined as “physical, chemical, or biological variables or a group of linked variables that critically contributes to the characterization of Earth’s climate” (Bojinski, 2014). The concept of essential variable has expanded also to other domains like biodiversity, ocean, social sciences, thus

A wide variety of approaches exist to observe the environmental and ecological impact of NBS. This section explores these methods, discusses how they can be applied and provides potential sources of data.

providing an excellent basis for building a NBS monitoring system. Another advantage of using the ECVs is that currently a lot of research is focusing to anchor the ECVs to Sustainable Development Goals and other international initiatives and their targets (e.g., ICCP, Sendai). Some studies place the ECVs between basic observations and indicators as single EV capturing a key process or structure can potentially contribute to multiple indicators, while similarly two or more ECVs can direct and use the same primary observations (Reyers, 2017).

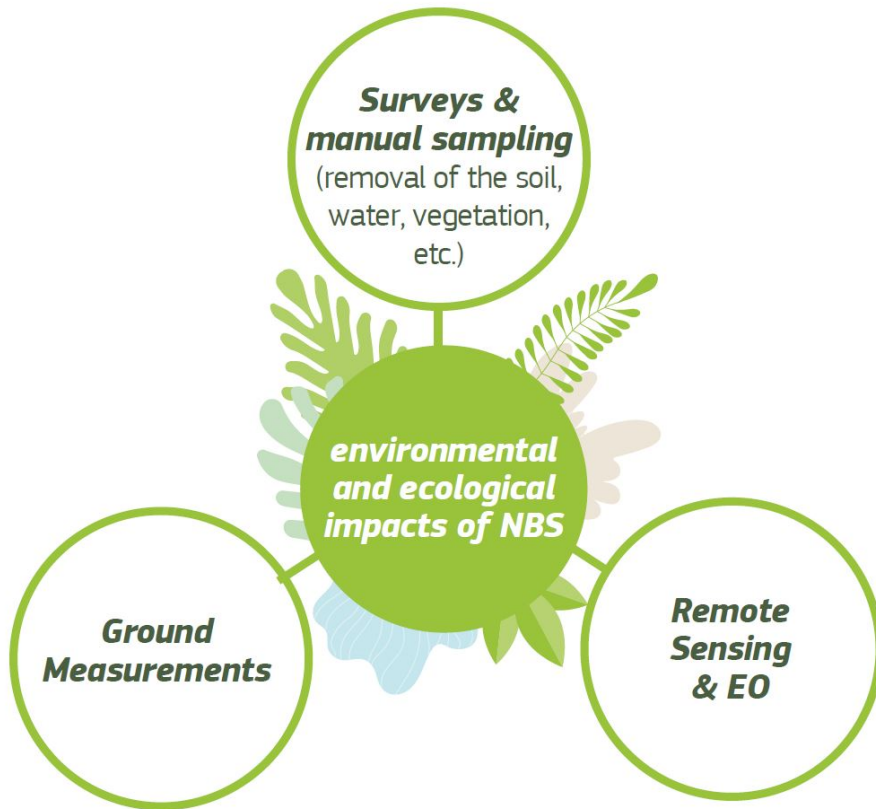

Figure 7-2. How can we generate and collect data to evaluate environmental and ecological impacts of NBS?

7.2.1 Remote sensing (RS) and Earth Observation (EO)

Remote sensing (RS) is the technique of observing and collecting information about an object or phenomenon from a distance, by means of sensors that are not in physical contact with the object of investigation (target). The platform employed to be “at a distance” from the target can be air-borne, space-borne or ground-based. Typical airborne platforms are drones and aircrafts, while satellites are used as space-borne platforms. Note that when the target of investigation is the Earth, the term Earth Observations (EO) is commonly used to indicate data gathered from Earth observing satellites. Finally, ground- (or sea-) based platforms consist of sensors mounted on tripods or moving vehicles. These platforms, along with drones, are mainly used for acquiring very detailed information at smaller spatial and temporal scales.

At present, a multitude of RS techniques is available, including visible and infrared imaging, light detection and ranging (LiDAR), and synthetic aperture radar (SAR). Multispectral sensors allow to study the changes of vegetation or built areas (land

use changes), while thermal imagery can be used for measuring the urban heat island effect. Beside satellite imagery, aerial photography is another important source of information about the Earth surface: LiDAR sensors, for example, allow gathering high-resolution elevation data, which can be applied for measuring the heights of trees or buildings.

Remote sensing and EO are also frequently used to analyse forest dynamics, pollution level, changes in soil erosion, an estimate of the animal population, and the impact of natural disasters. In the context of NBS monitoring, they provide affordable, high quality mapping and monitoring of urban and environmental parameters at multiple spatial scales (Kabisch et al., 2016). Table 7-1 provides some key examples of how global Earth observation data can be integrated into NBS models. It highlights how RS data can be used to improve the understanding of the processes controlling spatial and temporal dynamics of NBS.

Although EO and remotely sensed data mainly generate low spatial resolution outputs, they constitute a valuable asset for generating knowledge on a variety of aspects, including ecosystem and land-use changes, changing agricultural and forestry practices and climate-related variables, such as Earth's surface albedo, on global and pan-European scales.

One of the main advantages of RS and EO is their low-cost and vast availability which can greatly contribute to monitoring of NBS. A list of sources for EO data is presented in Table 7-3. In general, freely accessible data (free of cost) is provided by public agencies, under potential conditions linked to the application envisaged and the nationality of the entity requiring access. European Space Agency (ESA) provides detailed information on access to Earth Observation data products at

<https://earth.esa.int/web/guest/data-access>, where products can be browsed by mission and instrument, or by Earth topic, typology, and processing level. Data can also be bought from private companies operating commercial satellites, or by their numerous certified resellers. A unique source of freely available satellite data is the European Copernicus Program (<https://www.copernicus.eu>): the vast amount of EO data relevant to NBS monitoring is divided into 6 thematic domains. These data are freely available to all users via different channels. One of them is The Copernicus Open Access Hub which provides free and open access to not only raw and processed data, but also computational algorithms and cloud computing facility.

Table 7-1. Key examples of how global and European Earth observation data can be integrated into NBS models and how remote sensing can improve the understanding of the processes controlling spatial and temporal dynamics of NBS.

Theme analysed	Which particular data can be provided	Remote sensing data sources	Data Provider (SRS data product)
<p>Climate change (remote sensing to monitor the rate, magnitude, and spatial and temporal effects of climate on ecosystems)</p>	<p>Contemporary observations of ecosystem status and trend, together with environmental models, can help to estimate the ecological and economic effects of climate change and to develop and assess adaptation and mitigation plans</p>	<p>Some satellite remote sensing missions provide long-term records of land surface temperature and of vegetation, from which indices useful for understanding the dynamics of climate change can be derived.</p>	<p>Gas concentration: Terra/Aqua (MODIS), Nimbus-7/Meteor-3/Earth Probe (Total Ozone Mapping Spectrometer (TOMS) (1978-2006), Sentinel-5P (TROPOMI)</p> <p>See also: Copernicus Open Access Hub (Table 7-3)</p>
		<p>Data on other high-priority variables, such as: a) evapotranspiration and b) soil texture, moisture and chemistry are also measured by remote sensing</p>	<p>a) Thermal remote sensing, VIs, climate data; b) RADAR, HSI.</p> <p>See also: Copernicus Open Access Hub (Table 7-3)</p>
		<p>Time-series data on vegetation derived from multiple sensors contribute to understanding the temporal variability and trends in vegetation processes and their relation to climate.</p>	<p>a) Biomass, C storage - LiDAR, RADAR, multiangle RS; b) Photosynthesis, C sequestration - fPAR, photosynthetic efficiency, fluorescence, MODIS NPP</p> <p>See also: Copernicus Open Access Hub (Table 7-3)</p>
		<p>Climatological, meteorological, hydrological datasets. Operational, real-time and re-analysis datasets.</p>	<p>ECMWF Climate Data Store</p>

<p>Ecosystem processes</p> <p>(how remotely sensed ecosystem variables can be used to understand, monitor, and predict ecosystem response and resilience to multiple stressors)</p>	<p>Cost-effective information on ecosystem extent, status, trends, and responses to stressors over large areas (e.g. for quantifying ecosystem services inputs and associations between productivity, nutrient retention, health benefits etc.)</p>	<p>Landsat-derived maps for ecosystem services provision or a potential loss of ecosystem function.</p> <p>High spatial resolution and frequent revisits are most useful for documenting long-term effects of extreme events, such as severe storms, on ecosystem structure, function, and productivity, but increased spatial and temporal resolution imagery would likely result in a finer scale understanding of ecosystem responses to these events.</p>	<p>Barrier effect of vegetation (forest cover) - Landsat (TM, ETM+, OLI) Global forest cover change (200-2012); tree cover - Landsat (TM, ETM+, OLI) Landsat Tree Cover Continuous Fields (2000 and 2005)</p> <p>Biological control - changes in maximum NDVI (Terra/Aqua MODIS); pollination (vegetation phenology) - Terra/Aqua (MODIS) NDVI; Primary productivity - Terra/Aqua MODIS).</p>
<p>Ecosystem services</p> <p>(how remote sensing-derived products can be used to value and monitor changes in ecosystem services)</p>	<p>To document, monitor, and ultimately predict the extent and condition of certain ecosystem services (e.g. air purification, flood mitigation, water management, etc.) within a given area under current conditions and future policy scenarios.</p> <p>Also, to establish through analysis of remotely sensed vegetation cover the baselines for provisioning regulatory and cultural services in schemes of payments for ecosystem services.</p>	<p>Regular monitoring of ecosystem services such as: a) emissions of gases and carbon sequestration and storage; b) provision of shade and shelter: tree cover and plant canopy; c) temperature regulation (land and sea surface temperature); d) precipitation regulation (rainfall, evapotranspiration); e) water regulation: f) Inland water dynamic - Change in water stage and water body distribution; g) food - production of vegetal biomass; h) food - vegetation indices; provision of clean water, sustainable fisheries, and agricultural productivity with remote sensing from different sources.</p>	<p>a) (AVHRR), Terra/Aqua (MODIS), TRMM (CERES), NOAA AOML Surface CO2 Flux maps (1982-2009), LiDAR, RADAR, multiangle RS; b) Terra/Aqua (MODIS) - MODIS Vegetation Continuous Fields (2000-2013), Landsat (TM, ETM+, OLI) - Landsat Tree Cover Continuous Fields (2000 and 2005); c) Terra/Aqua (MODIS) - MODIS Land Surface Temperature and Emissivity, Sentinel 3 (SLSTR) for Land Surface Temperature; d) TRMM (PR, TMI, VIRS, CERES) precipitation estimates (1998-2015), Terra/Aqua (MODIS precipitation); e) Sentinel 3 (SRAL) altimetry; f) Terra/Aqua (MODIS) water mask, Landsat (TM, ETM+) - global surface water; g) Terra/Aqua (MODIS) - net primary production; h) Terra/Aqua</p>

			(MODIS) - MODIS FAPAR, MODIS LAI, MODIS Chlorophyll a
Changes in land use and land cover	<p>The global coverage and the spatial and temporal resolution of satellite observations allow mapping of these small- to large-scale changes.</p> <p>Note that more nations are launching satellites with high spatial resolution (30 m), but it is still a challenge to coordinate and calibrate the imagery from these systems to increase the frequency of observations.</p>	<p>Images with high temporal and low spatial resolution, such as those from MODIS, as well as images with high spatial and low temporal resolution, such as those from Landsat, or their combination.</p>	<p>MODIS, Landsat, or their combination.</p> <p>See also CORINE Landcover (Table 7-2)</p>
		<p>Images with high temporal resolution (daily for MODIS and visible infrared imaging radiometer suite vs. bimonthly for Landsat) capture the timing of vegetation changes, such as changes in phenology, and changes in chlorophyll levels.</p>	<p>Daily for MODIS and visible infrared imaging radiometer suite vs. bimonthly for Landsat</p>
Species distributions, abundances, and life stages	<p>Data on extrinsic environmental drivers such as land cover, primary productivity, density of human-made structures, habitat quality for given species.</p>	<p>Many of these variables are derived from existing multispectral sensors (e.g., MODIS).</p>	<p>Change in biomass, plant traits, land cover (Multitemporal RS)</p>
		<p>However, macroscale analysis may require deployment of new sensors such as satellite-based light detection and ranging (lidar) or 3-dimensional surface mapping and imaging spectrometers for better discrimination of features of heterogeneous terrestrial ecosystems. Derivation of data at finer spatial and thematic resolutions may require combination with on-site observation</p>	<p>a) Species map: Chemical or structural uniqueness, HSI, LiDAR, image texture; b) plant traits: spectral analysis or radiative transfer models; c) Spectral diversity of species (Range or variability of biochemistry, NDVI, or reflectance in set of pixels); d) Abundance of functional components (Spectral unmixing, MODIS Continuous Fields)</p>

<p>Degradation and disturbance regimes</p>	<p>To detect many types of disturbance that manifest in changes in land cover, air pollution, and different effects of global climate change.</p>	<p>Landsat data.</p> <p>Note that although global availability of hyperspectral data is limited, much progress has been made in the use of hyperspectral data to assess changes in ecosystems and function.</p> <p>Multi-sensor approaches may be particularly useful for assessing changes in ecosystems, especially when combined with ancillary data such as field observations and topographic data.</p>	<p>1) Fire occurrence and extent: Terra/Aqua (MODIS FIRMS), MODIS Burned Area Product, SPOT VGT Burned Area; 2) flood occurrence: Terra/Aqua (MODIS) - NRT Global Flood Mapping, TRMM (CERES) - Global Flood Monitoring System, DMSP (SSM/I), ERS-1, POES (AVHRR) -global inundation extent from multi-satellites (1993-2007); 3) drought occurrence: TRMM (PR, TMI, VIRS, CERES) - Satellite-Based Global Drought Climate Data Record, Eutrophication of water bodies - ENVISAT (MERIS), Terra/Aqua (MODIS), Sentinel 3 (OLCI)</p> <p>See also: EEA Air Pollution Index (https://www.eea.europa.eu/themes/air/air-quality-index)</p>
---	---	--	--

This and other available RS and EO data repositories represent a valuable tool for NBS evaluation, as they offer continuous long-term monitoring, and allow going back in time (thanks to archived images) and construct a baseline. Furthermore, thanks to latest technological improvements, high spatial and temporal resolution and improved accuracy of data can be achieved in some cases. In general, the following, generally accepted characterization of spatial resolution can be used for terrestrial applications:

- Low or coarse resolution, >1 km (e.g., advanced very high-resolution radiometer [AVHRR]);
- Moderate resolution, 250 m–1 km (e.g., moderate resolution imaging spectroradiometer [MODIS]);
- High resolution, 30 m (e.g., Landsat);
- Very high, approximately a few meters (e.g., IKONOS, Quickbird, and airborne remote sensing campaigns).

Table 7-3. Earth Observation data sources and their accessibility - selection of representative EO images providers (source: ESA, 2019).

Satellite data platform	Source of EO data providers	Public access / free of cost data	Commercial data
ESA	https://earth.esa.int/web/guest/home	✓	
EU Copernicus /Sentinel operated by ESA	https://sentinel.esa.int/web/sentinel/	✓	
Sentinel Hub	https://www.sentinel-hub.com/	✓	
EU Copernicus Open Access Hub	https://scihub.copernicus.eu/	✓	
EU Copernicus Data and Information Access Services (DIAS)	https://scihub.copernicus.eu/twiki/do/view/SciHubWebPortal/WebHome#dias-box	✓	
Copernicus portal	https://www.copernicus.eu	✓	
Eumetsat	http://www.eumetsat.int/website/home/index.html	✓	

European Environment agency (EEA)	https://www.eea.europa.eu/data-and-maps	✓	
USGS (Landsat)	http://earthexplorer.usgs.gov/	✓	
NOAA	http://www.ospo.noaa.gov/	✓	
NASA	https://earthdata.nasa.gov/earth-observation-data	✓	✓
Digital Globe resellers	http://www.digitalglobe.com/partners/certified-resellers		✓
Airbus	https://www.intelligence-airbusds.com/access-to-our-products/		✓
Deimos	https://www.deimos-imaging.com/imager-y-store/		✓
Planet Labs	https://www.planet.com		✓
ImageSat International NV	http://www.imagesatintl.com/about-us/		✓
UrtheCast	https://www.urtheCast.com		✓
MDA Geospatial Services	http://gs.mdacorporation.com/Partners/Partners.aspx		✓
E-geos	http://www.e-geos.it/index.html		✓
Satellite Imaging Corporation	http://www.satimagingcorp.com/		✓
CGG	http://www.cgg.com/default.aspx?cid=7450		✓
European Space Imaging	http://www.euspaceimaging.com/		✓

Land info	http://www.landinfo.com/		✓
Terra server	http://www.terra server.com/		✓
Apollo Mapping	https://apolloomapping.com/		✓

It is, however, important to notice that satellite observations have constraints and therefore should be ideally complemented by ground measurements and other high-resolution RS platforms such as drones. One of the main constraints of satellite images concerns the shadows due to the size of the frame, which can hide certain elements of the image and thus generate errors. This is particularly critical in dense environments such as cities. The **drone** technology is a viable way to provide the missing information and overcome this problem, as it offers the possibility to do 3D reconstruction and accurate geometric measurements. Indeed, while satellite imagery enables large spatial coverage with sometimes a resolution too low for the neighbourhood scale, drone imagery will collect high accuracy data in a more restricted area with the possibility of capturing different parameters depending on the drone equipment. This is particularly advantageous when there is a need for very detailed (or specific) and up-to-date information about the NBS intervention area.

Despite providing unique viewing angles otherwise not possible from manned aircraft, and representing a highly deployable technology already adopted in many applications (for humanitarian, safety, and economic reasons or simply for surveillance, precision agriculture and data/map acquisition), the use of drones for NBS monitoring remains at present quite unexplored. This is due to several limiting factors such as citizens safety, data and privacy topics, and the fact that some types of drone equipment are rather expensive and/or are restricted in flight limit zones where flight permission are required. Ground measurements, on the other hand, represent a more common and widely employed option to complement satellite data and they are also required for the validation of remote-sensed data. They are inevitable during the full process of NBS development. For example, to acquire a full cognition of the intervention area, the survey of its current biodiversity or the built surroundings can be performed only with ground measurements. This will be further discussed in Sections 7.2.2–7.2.3.

7.2.2 *In-situ observations and ground measurements*

In-situ (or local) observations is the technique of observing and collecting information about an object or phenomenon which is in close proximity to the observer or the measuring device (sensor). When in-situ observations are acquired by means of sensors placed either on or near the ground (or into deeper layers of it), then they are usually referred to as ground measurements. Data acquired through a standard weather station are an example of ground

measurements. Weather and other types of field monitoring stations usually capture a multitude of qualitative and quantitative environmental data on a continuous basis, including meteorological, hydrological, and chemical parameters. This approach has the advantage that data are typically collected using verified scientific methods and can be fed into data modelling processes to enhance the predictive quality of the data.

In-situ observations and ground measurements can be utilized for the assessment and monitoring of the surface and subsurface including terrestrial ecosystems (e.g., biota and soils), assessment of contaminated land, the follow-up of in-situ remediation technologies (in particular those for soils, vegetation, groundwater), as well as for monitoring micro-climate variations and air quality at the NBS site (Gruiz et al. 2017). Relevant data sources of in-situ observations are given in Table 7-4. These data are generated through dedicated observation networks which provide long-term and continuous monitoring of various environmental and physical parameters.

In addition, the recent advancements in smart, low-cost sensors and wireless technology is allowing to develop dense and low-cost wireless sensor networks in cities. The Wireless Sensor Networks of Heraklion, Greece, is an example of it⁵⁸. In general, Wireless Sensor Networks (WSN) can be used to measure air pollution, traffic, meteorological parameters, noise, water quality, animal tracking, different risks (landslides, forest fires, flooding, earthquakes), impact of industry (waste monitoring, machine conditions), health conditions (physical state tracking, health diagnosis). These data can be used as baselines for evaluation of NBS environmental impacts.

⁵⁸ http://www.rslab.gr/downloads_urbanfluxes.html

Table 7-4. Available data sources for in-situ observations and ground measurements (selection of six representative observation networks for environmental monitoring).

Name	Web link	Description
ICOS (Integrated Carbon Observation System)	http://www.icos-infrastructure.eu/	Measurement network dedicated to the monitoring of greenhouse gases budgets in 12 European countries since 2008 (Ciais et al., 2014).
GLEON (Global Lake Ecological Observatory Network)	https://gleon.org/	Grassroots network of limnologists, ecologists, information technology experts, and engineers who have a common goal of building a scalable, persistent network of lake ecology observatories (Weathers et al., 2013).
FLUXNET	https://fluxnet.org/	A global portal which hosts harmonized and integrated fluxes measurements (ecosystem carbon, water, and energy fluxes) provided by more than 800 sites (active or historic) around the globe. It includes smaller networks targeting specific land use types, such as urban area or inland water systems. Besides fluxes, ancillary atmospheric state variables, like temperature, humidity, wind speed, rainfall, and atmospheric carbon dioxide are also measured (Pastorello et al., 2017).
European Eddy Fluxes Database Cluster	http://www.europe-fluxdata.eu/home	The database hosts data acquired since 1996 in the context of previous and ended research projects, mainly funded by EU. Datasets include fluxes of different Green House Gases and ancillary atmospheric state variables, like temperature, humidity, wind speed, rainfall, etc.
European Environment agency (EEA)	https://www.eea.europa.eu/data-and-maps	The European Environment Agency gathers data and information on a wide range of topics related to the environment (pollution, water, climate, etc.)
EC Joint Research Centre (JRC) Data Hub	https://data.jrc.ec.europa.eu/	This catalogue contains a wide range of datasets of all science areas of the JRC

Given the extensive variety of parameters which can be measured through in-situ observations and the likewise wide range of NBS KPIs (see Chapter 4) which can be derived based on this data category, it would have been impossible to provides an exhaustive overview in the context of this handbook. However, it is important to notice that generation of in-situ observation data can represent a nature-based solution metric on its own (i.e., quantifying a change in air pollution

level by direct measurement) as highlighted by the key examples reported in Table 7-5. Furthermore, these environmental and ecological data (Table 7-5) are usually combined together with other measured parameters to create a combined metric (i.e., making ground observations of tree species, size, and Leaf Area Index (LAI) to support modelling of air pollution fluxes). However, due to the scale of the research field related to ground observations and nature-based solution evaluation, identifying the most appropriate/effective metric can be challenging. This is where detailed consideration of the NBS type, and associated theory of change (Chapter 2) are critical.

Table 7-5. Examples of indicators that have the potential to generate data using ground observations and how they have been used to assess NBS impacts with respect to Challenges 1 (Climate Resilience), 2 (Water Management), 3 (Natural and Climate Hazards), 4 (Green Space Management), and 6 (Air Quality).

Essential Variables evaluated through ground measurements	Indicators	Challenges
Direct Measurement of air temperature	Heatwave incidence expressed as the number of combined tropical nights (>20°C) and hot days (>35°C) per annum	1
Direct measurement of precipitation volumes and stormwater flowrates entering and leaving a NBS	<ul style="list-style-type: none"> • Surface runoff in relation to precipitation quantity • Flood peak height (m) 	2, 3
Direct measurement of water quality parameters	Water quality: total metals abatement (% reduction in metal pollutants with individual metal/metalloid pollutants selected based on initial conditions)	2
Direct measurement of air pollution parameters	Number of days during which ambient air pollution concentrations in the proximity of the NBS (PM _{2.5} , PM ₁₀ , O ₃ , NO ₂ , SO ₂ , CO and/or PAHs expressed as concentration of benzo[a]pyrene) exceeded threshold values during the preceding 12 months	6
Direct measurement of wind direction/speed	Total O ₃ , SO ₂ , NO ₂ , CO removed by NBS vegetation (unit of mass/year): modelled or measured	1, 6
Direct measurement of soil quality	<ul style="list-style-type: none"> • Total carbon removed or stored in vegetation and soil per unit area per unit time • Soil organic matter content (%) 	1, 4
Direct measurement of Tree size and Leaf Area Index (LAI)	<ul style="list-style-type: none"> • Total carbon removed or stored in vegetation and soil per unit area per unit time • Total PM₁₀ and PM_{2.5} removed by NBS vegetation (g/m² per year) 	1, 6

7.2.3 Surveys

Surveys are another valuable method of collecting in-situ data relevant to NBS environmental monitoring. Data acquisition is done through manual sampling (removal of the soil, water, vegetation, etc.) and samples are then analysed in laboratories or more often on-site by portable devices or in mobile laboratories (Grüz et al., 2017). However, the data are usually accompanied by uncertainties due to spatial and temporal (in particular, seasonal) heterogeneities typical for different environmental parameters.

Surveys are essential for studying diverse ecological phenomena (e.g., plant successions, species' population dynamics in an ecosystem, lake eutrophication, etc.) connected with the implemented NBS (Clobert et al., 2018). As an example, surveys can be used to assess the role of NBS in biodiversity enhancement by monitoring the abundance of living species in the NBS area and in its proximity. Indeed, NBS may contribute to enhancing connectivity by creating ecological corridors in urban context, thus enhancing biodiversity (including rare and threatened species; Bonelli, 2018; Nieto et al., 2014). Several biodiversity monitoring protocols have been developed and tested so far, and they are often adapted to the local needs, based on the NBS type, size, and on the stakeholders involved. All the reported protocols commonly shared the systematic approach. Examples of adopted protocols are reported in Table 7-6.

Table 7-6. Examples of biodiversity monitoring protocols (based on the monitoring activities conducted in the EU-H2020 project proGIreg). Source: Baldacchini (2019).

Category	Monitoring Protocols Adopted
<p>Pollinator biodiversity monitoring</p> <p>Pollinators play a key role in every terrestrial ecosystem. They are pivotal not only from a biodiversity conservation point of view, but also for food production and for global economy. Monitoring this insect group is very useful to evaluate the environmental status (EU Pollinators Initiative 2017, Underwood 2017).</p>	<p><i>Site: Urban park (Turin, Italy).</i></p> <p>Data sampling is conducted along specific transects, which allows the recording of associations between flowers and pollinators. Transect walks also offer the possibility to evaluate the success of NBS implemented by combining butterfly and bee responses at community level. Surveys are made from April to September. Windy and rainy days are avoided for all observations and samplings.</p> <p>Bee surveys: Each survey comprises 250m long linear transects walked in 50 min. Each transect start point and direction walked were randomly determined. All bees unambiguously identifiable are recorded and all others are caught for later identification. Bee richness and abundance are determined. The honeybee is identified to species level (<i>Apis mellifera</i>) while other bees are identified to genus level. Surveys are made at least one per month, between 9:00 am and 5:00 pm.</p> <p>Flower surveys: Larval food plants and adult nectar sources of butterflies as well as flower surveys are carried out in parallel to the bee and butterfly surveys along the transects.</p>

	<p>Butterfly surveys: Transects are 300-500 m long, depending on the investigated area (according to the “Pollard walk” (Pollard and Yates 1993). Butterfly species are identified, and individuals of each species counted. Surveys are made, every two weeks, between 10:00 am and 3:00 pm for butterflies.</p>
<p>Phytoplankton biodiversity monitoring</p> <p>Plankton plays an important role in fisheries, water pollution prevention and environmental impacts of water conservancy projects (Sun et al. 2018)</p>	<p><i>Site: Renatured lake (Ningbo, China).</i></p> <p>Water samples are collected once a week, for two years, at 3 sampling points, set at the inlet, outlet and centre of the lake. Samples are analysed under the microscope to identify the species and number of phytoplankton and zooplankton individuals present in each sample.</p>

7.3 Socio-economic, demographic and behavioural datasets for NBS monitoring and assessment: Methods and sources

Socio-economic, demographic, and behavioural data are essential in any NBS monitoring protocol as they allow assessment of the socio-economic and socio-cultural impacts of NBS, while also offering insight on public perception, degree of acceptance and aesthetic and/or recreational merit. In the EKLIPSE Working Group impact evaluation framework, for example, they are required for evaluation of many KPIs related to Challenges 6-10⁵⁹.

A valuable source of data which fall in this category is the Statistical Office of the European Union, Eurostat (Table 7-7). More generally, these data are usually available from government agencies such as National Bureaus (or Offices) of Statistics. However, data retrieved from the aforementioned sources have often constrains and limitations due to the unavailability of updated statistics, especially in small areas such as neighbourhoods and suburban areas, or due to the lack of analysis which target specific data needs for the implementation and monitoring of a NBS (e.g., distribution of people for single age group in small areas).

Socio-economic data represent a valuable resource for evaluating nature-based solutions. This section explores types of socio-economic data, different methods for collecting them, and examples of their relevance.

⁵⁹ 6: Urban Regeneration; 7: Participatory Planning and Governance; 8: Social Justice and Social Cohesion; 9: Public Health and Well-being; 10: Potential for Economic Opportunities and Green Jobs (see Chapter 5)

Table 7-7. Relevant databases of statistical data (incl. socio-economic and demographic)

Name	Web link	Description
Eurostat (Statistical Office of the European Union)	https://ec.europa.eu/eurostat/data/database	Supplier of a broad range of socio-economic data. Specific data themes includes economy and finance; population and social conditions; industry, trade and services; among others (full list available at: https://ec.europa.eu/eurostat/data/browse-statistics-by-theme). It also provides statistics in alignment with the targets of the Sustainable Development Goals.
Socioeconomic Data and Applications Center (sedac)	https://sedac.ciesin.columbia.edu/	It includes various types of statistical data (in form of spatial dataset and maps) at global scale, including population density and distribution, anthropogenic biomes, population dynamics (migration, fertility, and mortality), poverty, etc.
OECD Datasets	https://data.oecd.org	Comparisons by topic and country of several categories of data
World Bank Open Data	https://data.worldbank.org/	It includes a variety of regional or county-level datasets in tabular format, vector or raster geographical data and unit-level data from sample surveys and administrative systems.
Infrastructure for spatial information in Europe (INSPIRE) Knowledge Base	https://inspire.ec.europa.eu	The INSPIRE Knowledge Base was developed after the adoption of the INSPIRE Directive (2007/2/EC). The Knowledge Base comprises of datasets on multiple environmental, demographic and socio-economic domains.
Risk Data Hub (DRMKC)	https://drmkc.jrc.ec.europa.eu/risk-data-hub	The risk data hub is an open access platform for risk related geospatial data in Europe. The data hub encompasses current and future hazard and exposure analysis as well as loss and damage data of historical events. The data is available on different scales based on the NUTS classification in Europe.
ClimateAdapt	https://climate-adapt.eea.europa.eu/#t-database	ClimateAdapt offers a list of statistical and spatial indicators on climate change adaptation. In addition, the database includes other data types (videos, publications, case studies and more).

In cases when data are unavailable (or inadequate), a customized data collection is required, which becomes the sole solution for monitoring the socio-economic performance of the NBS interventions. Under this perspective, a wide range of collection data methods exists including qualitative analysis (focus group, observational methods), surveys, and co-participation methods. Therefore, the following sections encompass the main approaches and methods adopted in this context and present practical examples of their applications. Although each data collection method is presented here as standalone, it is important to recognise that socio-demographic and behavioural data are often and preferably the result of mixed and integrated approaches which rely on multiple data types and methods discussed hereafter.

7.3.1 *Quantitative, qualitative and map-based surveys*

Surveys represent a well-known and widely adopted method of collecting sociodemographic, economic, and behavioural data. They can be differentiated into quantitative, qualitative, and spatially anchored (map-based) surveys, depending on the specific data needs and research approach adopted.

Quantitative surveys are primarily conducted with questionnaires. Following the definition of Creswell (1999), quantitative research aims at “explaining phenomena by collecting numerical data that are analysed using mathematically based methods (in particular statistics)”. Data gathered through quantitative surveys are indeed – and by definition – expressed in numerical format and therefore they can be managed and analysed statistically (as opposed to qualitative survey data which are usually non numeric). The quality of collected data represents a crucial aspect in a quantitative survey. To ensure quality, relevance, simplicity, accuracy and clarity of the questionnaire (or any other measuring instrument) should be carefully verified before the start of the investigation. Choice of the proper sampling approach (probabilistic vs. not probabilistic), calibration of the measuring instrument (e.g., questionnaires) as well as identification of suitable strategies for data collection are also critical factors to be considered.

Qualitative surveys are primarily conducted with interviews. They are a common method adopted in qualitative research, which can be described as explanatory research aiming at understanding a context or underlying reasons and motivations (e.g. what are people perceiving about an NBS or why are they perceiving it like this?). In contrast to quantitative data, *qualitative data aim at describing, and not at predicting*. They are typically not numerical but can be analysed using more recent statistical methodologies that do not necessarily emphasise the numerical aspect but rather the relationships. In general, data gathered from qualitative surveys are more complex than quantitative ones and have also constraints in terms of generalisations and upscaling due to the small size of the population sample investigated. However, tools used for qualitative surveys are very versatile and have a participatory character. Common tools include open-end questionnaire, one-person-interview, and focus groups.

Focus groups are used to gather a larger number of information emerging from group discussions on a specific topic and are led by an expert moderator (facilitator). This measuring instrument has proven to be very useful in the building-up phases of any process, since it investigates perceptions, opinions, beliefs and attitude towards a product or process. Although this vast amount of information is difficult to categorise in a systematic way, it represents a valuable and effective tool to allow the monitoring and consequent adaptation of NBS planning and implementation. Focus groups would therefore be a useful opportunity for enabling people in participating in a real co-design NBS process and for preventing marginalization and social exclusion in the social-ecological context in which they are embedded. Furthermore, engaging stakeholder in the process of decision-making on NBS can, simultaneously, increase the performance of an intervention (Woroniecki, 2019).

Map-based surveys are online questionnaires that are increasingly used to enhance public participation as well as co-creation (Linden and Sheehy, 2004). This type of survey data allows for automatized spatial anchoring of the collected survey data. It is a participatory tool for collecting primarily socio-economic data but also for establishing the opportunity for citizens to actively engage in decision-making and, simultaneously, enhancing transparency, trust and satisfaction in planning processes. The added value of collecting spatial anchored survey data for NBS monitoring and assessment can be further highlighted by considering, for instance, monitoring small scale changes or understanding risk perceptions which are often place-based. These survey studies can also be conducted with the aid of various software products currently on the market. An example is Maptionnaire (<https://maptionnaire.com>), which is a software for map-based questionnaire to facilitate public participation. It can be used, for instance, to learn more about public perceptions and acceptance of NBS. The software offers a working space for direct data analysis and management. Furthermore, the data can be exported to shapefiles, XLSX and other data formats. Another example of a map-based surveys is using crowdsourcing application Ushahidi (<https://www.ushahidi.com/>). The application has been customized within the EU-H2020 project Operandum to collect information about the existing NBS installation at the global scale using simple questionnaire with mapping application (see Figure 7-4 in Section 7.7).

Overall, surveys represent an effective method for collecting both qualitative and quantitative data relevant for monitoring the sociodemographic, economic, and socio-cultural system context in which NBS are embedded. Results derived from the EU-H2020 CONNECTING Nature project offer a meaningful example on how survey data can be used to assess socio-economic benefits from NBS. Specifically, the concept of semi-structured interviews using questionnaire was developed as part of the research work in the project. Data gathered from these interviews represent an example of 'process indicators' since they enable evaluating the processes involved in successful (and unsuccessful) nature-based solution delivery.

Figure 7-2 summarises the CONNECTING Nature study and shows the interview template developed for that purpose. In other cases, such as the EU-H2020-project Nature4Cities, specific questionnaires are developed in local language to

clarify whether the local stakeholders in the pilot cities of the project understand the benefits and trade-offs of an NBS implementation case.



Figure 7-3. Interview template including the six-step iteration applied in the survey of Connecting Nature project (Dushkova and Haase, 2020).

In CONNECTING Nature, experts dealing with implementing NBS in particular cities were interviewed on emergent, innovative, and novel NBS using templates (questionnaires). The aim was to identify lessons learned that will benefit other cities and stakeholders who are interested in designing, implementing, and stewarding NBSs. The interviews were supplemented by site visits and participant observation including those during open public events, urban festivals, public lectures, guided excursions, and other events. The interviews allow to analyse the following aspects important when planning and implementing a specific NBS:

- Factors of success of NBS examples – what in particular has contributed to the successful existence of selected NBS examples (e.g., by looking at the history of their creation, their impact, governance models, methods of implementation, design and maintenance, additional benefits, costs and financing);
- Impact of NBS examples on the environment, economics, society and sustainable development of the city, to better face current societal challenges, especially the consequences of climate change in cities and urban regions;
- Trade-offs and conflicts around the NBS – identifying the potential barriers for the implementation of effective and durable NBS (Dushkova and Haase, 2020)

Besides, a broad category of computer-assisted approaches has become increasingly popular for conducting survey studies, such as computer-assisted web interview and computer-assisted self-interviewing, while more traditional tools such as paper and pen data collection, or questionnaires by post, tend to be less used. For example, a web-based survey has been developed in the scope of the EU-H2020 project EdiCitNet in order to collect data on the social, economic and environmental performance of Edible City Solutions (ECS)⁶⁰. The web-survey adopts a colloquial and friendly language and has been co-developed with local ECS, building upon three main scientific theories on the emergence and diffusion of similar initiatives: strategic niche management, grassroots innovations and fertile soil (Sekulova et al., 2017; Seyfang and Longhurst, 2016; Wolfram, 2018).

7.3.2 Population observations

Although surveys remain the most popular data collection method used in research with humans, in-situ observations represent another possible – and usually complementary – approach for collecting sociodemographic and behavioural data in connection with an implemented NBS. As explained in Section 7.1, observational tools differentiate from surveys for the fact that data are collected *without* interacting with the object of the research: human behaviour is observed from afar, and it is registered, according to specific, validated protocols.

⁶⁰ ECS are edible nature-based solutions, i.e., NBS related to urban food production, processing and use

This type of in-situ observations is particularly useful when trying to gather up-to-date and detailed data in small areas such as neighbourhoods and suburban areas. For example, certain types of NBS such as public parks, urban forests, tree corridors, renatured river or lake shores, have the benefit (or co-benefit) to provide (or provide access to) a space that the population can use to visit green and/or blue spaces and/or for physical activity. To evaluate whether this is effective, systematic observation can be performed on-site in order to monitor the use of the NBS and to assess the related changes in time (before and after NBS implementation).

A method to quantify the use of a green/blue space is, for instance, the validated SOPARC (System for Observing Play and Recreation in Communities) tool (McKenzie et al. 2006; https://www.rand.org/health-care/surveys_tools/soparc/user-guide.html). SOPARC can provide data on the number of users and type of physical activity, which represent a common data requirement for Challenges 7 (Place Regeneration) and 11 (Health and Wellbeing), and related indicators.

To summarise the method, trained observers (possibly including participation of stakeholders) count the number of users at the NBS site and register the users' characteristics (sex and age group) and type of activity (e.g., sedentary, walking, or very active). These observations are systematic and periodic; measurements are taken in specific periods of time (morning, lunchtime, afternoon, and evening) and specific days (within one week). These periods are defined to get an overall estimate of the use of the site.

To evaluate the change in use and physical activity, systematic observations can be performed before and after the NBS implementation is monitored, taking care of repeating the data collection in the same season. In the case of NBS implementations in pre-existing public green area, a single post-implementation SOPARC assessment can be conducted, to describe NBS users and their behaviour.

While in-situ observations such the one collected with SOPARC provide standard quantitative data, other methodologies exist which also provide qualitative data. For examples, methodologies which integrate visual techniques such as photography, film, video, painting, drawing, collage, sculpture, artwork, graffiti, advertising, and cartoons are increasingly used in multiple disciplines (Pain, 2012). These methodologies can be used to measure in an indirect way the crowding of parks without quantitative research: the longitudinal mapping of graffiti can be considered as proxy of artistic expression or cultural dimension.

7.4 Data sources for the assessment of changes to health and wellbeing

There is an increasing recognition of NBS co-benefits as influential determinants of human health and well-being (Barton and Grant, 2006; Hartig et al., 2014; Kabisch et al., 2017). They relate to the provision and improved availability of urban green spaces and may result in better mental and physical health. A great

number of the scientific literature provides results of how different urban nature-based solutions can affect the health of urban residents and present epidemiological evidence of public health benefits of green spaces (Beyer et al., 2014; ten Brink et al., 2016; Dushkova and Ignatieva, 2020; Frumkin et al., 2017; Groenewegen et al., 2006, Kabisch et al., 2017; Kabisch and Haase, 2018; Marcel et al., 2019; Williams, 2017; Wood et al., 2016). There are three urban health dimensions, namely environmental conditions and related health outcomes, urban equity and vulnerability as well as resilience to extreme climate conditions related to climate change.

There are many direct links between nature and human health and well-being which resulted from the epidemiological surveys. Thus, connection with nature, in addition to satisfying elementary human needs (e.g., food and natural resources supply), heals or mitigates the most diseases and can be defined as a health resource (which keeps people healthy) (Groenewegen et al., 2006;

Health & Wellbeing represents an emerging and often complex approach to evaluating NBS impacts due to issues of causality. This section explores the types of data and approaches that can be used to assess NBS impacts on health and wellbeing.

Kabisch and Haase, 2018). The recreational and healing value of nature for physical health and mental well-being has long been discussed (Beyer et al., 2014; Hartig et al., 2014; Marcel et al., 2019). However, nature also has another value for health, regardless of natural remedies (though often not consciously perceived). For example, the healing of space, outdoor training

trails in parks, everyday use of urban green spaces and peri-urban recreation areas for sport and exercises (cycling, jogging, and Nordic walking). These health aspects of outdoor nature are used for promotion healthy life-style, especially for children, through the active nature experience, since many children in urban spaces no longer have the opportunity to acquire nature in everyday life experience (Kabisch and Haase, 2018). Thus, as a source of healing, and source of inspiration, nature plays an important role in the identity of people and in the development of its own "sense of place" (Frumkin et al., 2017).

While the provision of nature-based solutions refers traditionally to environmental organizations and planners, greater involvement of the health sector will be important for maximizing benefits for both health and nature. Integrating policy on biodiversity, health and urban planning to realize joint benefits requires data from all fields to be linked and communicated to policy makers, to be considered in impact assessments and economic valuation of decisions (Kabisch et al., 2017).

Main types of data needed to study the relationship between NBS and human health are:

- Quantitative data from case studies – epidemiological survey and regional statistics; often, local practitioners benefit from quantitative data and it is helpful to consider early in the process what quantitative data could be obtained with reasonable effort. The use of routinely collected statistical data on local level should be maximized. Yet, the use of other types of

arguments and measurements to complement the quantitative data is necessary to avoid that the lack of quantitative data is interpreted as a lack of evidence in general;

- Qualitative data (e.g., from semi-structured interviews) which can allow to capture all the needs of the varying community subgroups. The interviewing of the intended users of the intervention could be a good way to gain understanding of their needs as well as their experience with similar NBS implemented earlier in another place. Various techniques can be used to collect these data such as using maps during interviews to gain a robust understanding on how people use and move in and around local green space.

Literature review shows that very often the following study design was applied:

- Cross-sectional questionnaire survey of women or/ and men (mostly separating adults from children). Stratified random or cluster sampling design;
- Observational study of the usage of urban parks or other NBS - direct observation of park users as well as interviews with persons;
- Survey data combined with GIS and green space data, and their analysis;
- Ecological study of mortality and dasymetric mapping of air pollution and greenness;
- Observational ecological study comparing neighbourhood socioeconomic status of women and individual physical activity;
- Self-administered survey of persons on their perceived general health and the characteristics of their living environment;
- Health interview survey of persons that examined self-reported health, social contacts, and characteristics of the respondents' living environments.

Several guidelines were established by WHO (2017) for simple data collection methods to identify and assess the value of urban green and other nature-based solution for human health and well-being:

- Use observational data as a relatively simple and cost-efficient way to assess how many people are using green space, what types of people are using it, who they are using it with, for what purposes etc.;
- Use existing audit and observational tools to collect information on play and recreation in public areas;
- Consider simple and innovative monitoring techniques (e.g., user satisfaction counters like seen in public facilities);

- Engage with local networks and organizations as a way to collect feedback from community and green space users (e.g., engage with community councils or committees);
- Collaborate, where possible, with academic institutes and research centres which can aid with delivering effective monitoring and evaluation for the intervention as well as cost-efficient monitoring (e.g., through developing student research projects around the NBS intervention).

It is important to consider existing, routinely collected datasets and how these might be utilized. Some national or local municipality surveys may already have baseline information on how people currently use and value local NBS, what effects were reported and analysed. Good demographic data on local residents and intended users of the green space is critical for informing the planning and design of the intervention.

Often, socioeconomic status data but also other data (e.g., on environmental risk exposure, age and sex, or ethnic and other sociocultural parameters) are available through standard processes on local level. Such data may often be available in aggregated form for an urban/neighbourhood area rather than as individual data. In such cases the smallest-possible spatial unit should be considered, since understanding the population profile is important to define equity issues (WHO, 2017).

The role of citizen science and participatory research in evaluation should be considered. This may aid data collection and evaluation, and would also help to increase the active uptake of the NBS interventions.

The literature reports on **positive** health associations for a diverse range of NBS interventions such as street trees, green space establishment on vacant lots and greening school playgrounds. Reported benefits in terms of reduced exposure to air pollution are substantial, and usually complemented by others of social (green spaces for the public) and/or economic nature (new job and business opportunities).

However, implementation of urban green infrastructure can result in **negative** impacts on the local air quality such as the direct emissions of pollen, fungal spores and biogenic volatile organic compounds (bVOCs). It is thus of paramount importance an informed choice of the most appropriate species prior to deployment. The scale and physical dimensions of the deployment are also critical and need to be assessed case by case, and the outcomes of similar green infrastructures may vary considerably in different urban environments (Kumar et al., 2019).

However, it is important to think in a broader sense when planning NBS interventions. This means to realize the opportunities for collaboration with institutes such as schools, universities and health services which may enable access to relevant data sets and help with informing the design of the intervention. The potential of NBS co-design activities with schools and universities has been, for example, demonstrated in one of NBS being implemented within the framework of the EU-H2020 project OPERANDUM: these

activities have shown to have the multiple benefit to introduce climate action in education with potential positive impacts towards the realisation of the objectives of SDG11 and SDG13. Also, broader interventions (such as urban extensions, large infrastructure projects or masterplans for residential areas) could consider and include urban green space and be informed by the benefits of such provisions.

7.5 Predicting the present and future impacts of NBS with modelling techniques

Modelling is a critical and often compulsory aspect of NBS impact assessment (Figure 7-3). It allows to simulate the efficiency of one or more components of NBS, and to monitor and evaluate progress towards its goals. Here, the term *modelling* is employed to denote any type of modelling for any Essential Variable. Various modelling approaches, from lumped to distributed models, require a varying level of complexity of the described environment.

Modelling NBS addresses the representation of processes that occur in the real world in space and time. The processes resulted or caused by NBS transform the environment through time and can be mostly described by dynamic models based on differential equations. The spatial interactions of different elements of NBS and NBS with the environment are

In addition to direct measure and observation, modelling also represents a potential mechanism for generating data on NBS impact assessment. This section discusses a range of modelling approaches and their potential applications.

mostly managed by geographic information systems (GIS). GIS can be used to provide input variables required by simulation models and yield visualization and analysis of output data. Other ways are represented by direct integration of numerical modelling which is a mathematical representation of a physical (or other) behaviour, based on relevant hypothesis and simplifying assumptions. Various simulation tools together with GIS are used to demonstrate modelling of, for instance, surface water pollution, spatiotemporal analysis of air pollution data, modelling of land use changes (Cohen-Shacham et al., 2016). Another type of modelling – physical modelling – is used to validate numerical modelling data; the use of physical models supports the understanding design concepts and processes. Modelling combined with scenarios provides insights into drivers of change, potential implications of different trajectories, and options for action (Sang, 2020). Section 7.1.7 presents a more detailed discussion on the modelling approaches and their complexity.

Modelling approaches are primarily adopted for one or more of the following purposes:

- **Identify and/or understand the underlying processes which describe with certain level of uncertainty relevant environmental (or behavioural) response/change of the urban system before (baseline) and after the NBS intervention.** For example, models can

simulate different natural processes such as crop growth, flooding, and local climate regulation (e.g., Mohareb et al., 2012) by green space or soil nutrient flow. In that respect, the advantage of modelling techniques relies on the possibility of changing input data and parameters to be in the model. This allows to understand cause-effect relationships and to make predictions at a level which is not possible with observations.

- **Identify vulnerable urban areas and/or areas which are more prone to certain natural hazards** (e.g., flooding). When implementing nature-based flood protection, for example, it is essential to conduct a probabilistic hydrological and hydraulic modelling assessment and map flood zones with the potential intensity and location of all relevant types of flooding (Mason et al., 2007; Pregnolato et al., 2016; Raymond et al., 2017). Such resulted maps of potential inundation will present a range of return periods and appropriate planning needs. Other techniques include modelling of flood peak reduction (Iacob et al., 2014) or modelling of options for stormwater management in the urban environment, including the quantification of SuDS benefits with the BeST model (Morales-Torres et al., 2016).
- **Generate (or use) simulation data to fulfil the data requirements for specific KPI, especially when other data collection methods are not feasible/too expensive, or data are simply not available or adequate.** For example, gross and net carbon sequestration of urban trees can be estimated with the iTree Eco model (Baró et al., 2014), which provides a database on ecosystem services rendered by different trees species in different climatic zones.
- **Improve awareness and perception of NBS co-benefits and efficacy through scenario and impact modelling.** For example, superior performances and co-benefits of a specific NBS versus more traditional interventions (e.g., grey infrastructure) can be verified through modelling studies (e.g., Gittleman et al., 2017), and effective communication of these results may enhance acceptance and engagement among stakeholders and policymakers. In that regard, it is worthwhile to mention that models not only represent the environmental impact of NBS, but they can also model the societal responses and participatory process by applying methods such as geodesign. As stated by Steinitz (2016), geodesign helps to find consensus around plans with sufficient detail to be workable, adaptable to the local needs and context and sustainable over time. Additionally, development of innovative social models for long-term positive management (e.g., Citizen Engagement for Health; Fernandez et al., 2015) may also contribute to increasing stakeholder awareness and knowledge about NBS and ecosystem services, as well as citizen participation in the management of NBS (Filibeck et al., 2016; Hansen et al., 2016).
- **Develop design scenarios for the selection of the optimal NBS** among the ones conceivable, and for estimation of efforts needed for its implementation and maintenance.

- **Forecast NBS performances and impacts over time and/or in connection with future climate projections.** In this regard, extensive research modelling efforts have been made to assess effectiveness of NBS in tackling challenges such as climate change, food security and water resources. Furthermore, the use of natural hazard modelling has been expanded and combined with numerical weather prediction and climate models to develop climate change adaptation and disaster risk reduction strategies that are resilient, adaptable, resource efficient, locally adjustable and optimised.

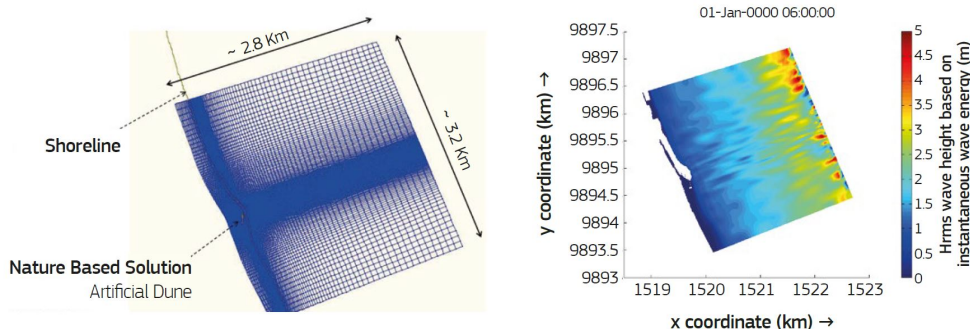

15.

Figure 7-4. Simulation of hydrodynamic and morpho-dynamic processes to assess the effect of NBS (artificial sand dune) on wave propagation. Left: Numerical Domain showing the position of the NBS along the shoreline. Right: model results showing the wave propagation (source: EU-H2020 project OPERANDUM; image credit: ARPAAE-IT)

Despite their numerous advantages and countless applications, modelling techniques have also limitations and uncertainties which should never be neglected in the evaluation process and/or while using modelling results. Some of these limitations and uncertainties are intrinsic to the technical or mathematical structure (or logical framework) on which the model is built, and on the assumptions and/or approximations which may be embedded into it. For that, simulation results must be compared to and validated against observational data to ensure the validity of results and also the quantification of the overall uncertainty of the simulated scenario assessed. Errors and/or misleading results can also be generated by an “inappropriate” use of the model. Indeed, every model is built to address only specific research questions and is meant to be used only for certain specific applications and contexts. Knowledge of the model goals and capabilities is thus crucial in order to select “the right tool for the right problem”.

A variety of numerical models exists that are used to simulate the state variables such as temperature, precipitation and evapotranspiration. Table 7-8 lists the relevant modelling tools for assessing ecosystem services provided by NBS. A non-exhaustive list of the most widely used numerical models can be classified under the following Challenge areas:

- Climate resilience
 - General circulation models (GCM) (Mechoso and Arakawa, 2015)
 - Weather Research and Forecasting Model (WRF) (Surussavadee et al., 2017)
 - complex numerical methods describe the interactions between vegetation and pollutants at the micro scale (Joshi and Ghosh, 2014) or simulate the emission and deposition processes based on trajectory and dispersion models, e.g. the atmospheric transport FRAME (Fine Resolution Atmospheric Multi-species Exchange) model (Bealey et al., 2007).

- Water management
 - MIKE11 (Thompson et al., 2017)
 - Soil Water Assessment Tool (SWAT; Arnold et al., 2012)
 - Storm Water Management Model (SWMM) (Rossman, 2015)
 - MODFLOW model (Langevin et al., 2017)
 - GREEN (JRC) (Grizzetti et al., 2012)

- Natural and climate hazards
 - Discrete Element Method (DEM) (Mahmood and Elektorowicz, 2016)
 - ADvanced CIRCulation (ADCIRC) (Luettich et al., 1992)

Table 7-9 presents a selection of studies obtained from the scientific literature, which show the ways simulation and modelling can be applied to the assessment of NBS impacts in the urban environment.

Table 7-8. Modelling tools for the assessment of the ecosystem services provided by NBS.

Tool/Model	Description	Source	Comment
Artificial Intelligence for Ecosystem Services (ARIES) / probabilistic model	A networked software technology that redefines ecosystem service assessment and valuation for decision-making, to map natural capital, natural processes, human beneficiaries, and service flows to society as a new way to visualize, value, and manage the ecosystems on which the human economy and well-being depend; to quantify the benefits that nature provides to society	http://aries.integratedmodelling.org/	ARIES is meant to enable simple use of complex models through artificial intelligence; as such, extensive training (annual intensive modelling schools) is only necessary for modellers who want to contribute to, and benefit from, ARIES models and data.
The Atlas of Natural Capital (ANK) / Spreadsheet	Up-to-date platform for knowledge and information dissemination enhancing the sustainable use of natural capital (currently more than 150 maps on ecosystem services in the Netherlands)	www.atlasnatuurlijkkapitaal.nl/en	Companies, governments and citizens can use data from ANK
The Ecosystem Services Mapping tool (ESTIMAP) / GIS application	A collection of spatially explicit models to support the mapping and modelling of ecosystem services at European scale. Its main objective is to support EU policies with spatial information on where ecosystem services are provided and consumed.	Zulian et al. (2014)	It is based on the ecosystem services cascade framework which is used as a frame for mapping; it includes four complete models: outdoor recreation, crop pollination, coastal protection and air quality regulation.
Benefits Estimation Tool (BEST) / Spreadsheet	Benefits Estimation Tool – valuing the benefits of blue-green infrastructure. It assesses and monetizes many of the financial, social and environmental benefits of blue-green infrastructure; it enables users to understand and quantify the wider value of Sustainable drainage systems and natural flood management measures	https://www.susdrain.org/resources/best.html	A free tool and guidance for use on PCs. It makes assessing the benefits of blue-green infrastructure easier, without the need for full scale economic inputs; it can support investment decisions and help to identify stakeholders and find potential funding routes.
i-Tree (formerly Urban Forest Effects Model) / Desktop software	Based on peer-reviewed, USDA Forest Service Research, it offers several desktop and web-based applications to quantify the benefits and values of trees around the world, to aid in tree and forest	https://www.itreetools.org/	i-Tree is a combination of science and free tools; it provides users/managers with tools by allowing them to improve tree and forest management, plan strategically, increase

	management and advocacy, to show potential risks to tree and forest health		awareness, engage decision makers and build new partnerships.
ESValues / Spreadsheet	A collaborative platform that collects economic data from ecosystem services studies to produce value estimates by benefit transfer	https://esvalu.es.org/	It allows users to obtain economic values for the ecosystem services provided by an ecosystem and upload the parameters and estimates from these economic valuations
Integrated Valuation of Ecosystem Services and Tradeoffs (InVEST) / GIS software	A suite of models used to map and value the goods and services from nature that sustain and fulfill human life. It helps explore how changes in ecosystems can lead to changes in the flows of many different benefits to people. The toolset includes distinct ecosystem service models designed for terrestrial, freshwater, marine, and coastal ecosystems, as well as a number of “helper tools” to assist with locating and processing input data and with understanding and visualizing outputs.	https://naturalcapitalproject.stanford.edu/invest/	Free, open-source software models; it enables decision makers to assess quantified tradeoffs associated with alternative management choices and to identify areas where investment in natural capital can enhance human development and conservation.
A Global Standard for Nature-based Solutions / Spreadsheet	Developed by IUCN in order to create a common understanding and consensus on Nature-based Solutions, the Ecosystem Management Programme and Commission are jointly leading the collaborate process of elaborating a Global Standard for the Design and Verification of Nature-based Solutions.	https://www.iucn.org/themes/ecosystem-management/our-work/a-global-standard-nature-based-solutions	Not yet available (still in the developing stage)
Land Utilisation Capability Indicator (LUCI)	An ecosystem services modelling tool which illustrates the impacts of land use on various ecosystem services. It runs at fine spatial scales and compares the current services provided by the landscape with estimates of their potential capability. LUCI uses this information to identify areas where landscape usage change might be beneficial, and	https://www.lucitools.org/	LUCI is relevant for a range of users at multiple scales and levels of decision-making. It can be applied for applications around sustainable development, conservation, sustainable tourism, restoration, and policy-making.

	where maintenance of the status quo might be desirable.		
The NATURVATION index / Spreadsheet	The Naturvation Index (proposed by the EU-H2020 project NATURVATION) to evaluate nature-based solutions projects and identify how they contribute to sustainability goals.	https://naturvation.eu/assessment	Value and Benefit Assessment Methods Database and Framework for Urban Nature-based Solutions
Social Values for Ecosystem Services (SolVES) / GIS application	A GIS Application for Assessing, Mapping, and Quantifying the Social Values of Ecosystem Services – SolVES 3.0 tool which is ArcGIS 10-compatible.	https://solves.cr.usgs.gov/	SolVES derives a quantitative, 10-point, social-values metric, the “value index”, from a combination of spatial and nonspatial responses to public value and preference surveys and calculates metrics characterizing the underlying environment, such as average distance to water and dominant land cover.
The Economics of Ecosystems and Biodiversity (TEEB) Valuation Database / Spreadsheet	The Manual presents an overview and explains the potential uses and functions of the TEEB Valuation Database. The Manual discusses the origin of the database; describes its content and structure; outlines its contents and discusses how it may be used, including important caveats.	http://www.teebweb.org/publication/tthe-economics-of-ecosystems-and-biodiversity-valuation-database-manual/	It allows for user the evaluation of ecosystem services, but not measure the quantities and not allows to input the data
Toolkit for Ecosystem Service Site-based Assessment (TESSA) / Spreadsheet and GIS application	The toolkit provides practical guidance on how to identify which services, what data are needed to measure them, what methods or sources can be used to obtain the data and how to communicate the results. The toolkit has attempted to find a balance between simplicity and utility and can be used by non-experts, yet still provide scientifically robust information.	http://tessa.tools/	It emphasizes the importance of comparing estimates for alternative states of a site (for example, before and after conversion to agriculture) so that decision-makers can assess the net consequences of such a change, and hence the benefits for human well-being that may be lost through the change or gained by conservation.

<p>Copernicus, Corine Land Cover by EEA (European Environment Agency)</p>	<p>Copernicus Land Monitoring Service portfolio (both already operational and upcoming) products are divided into the following categories: Land Cover and Land Use Mapping Hot-spot Monitoring Biophysical Parameters Imagery, In Situ and Reference Data European Ground Motion Service</p>	<p>http://land.copernicus.eu/pan-european/corine-land-cover/clc-2012/view</p>	<p>Corine Land Cover (CLC) 2012, Version 18.5.1. Processed by The European Topic Centre on Land Use and Spatial Information</p>
<p>The assessment of ecosystem and their services – approaches from LIFE program of European Commission</p>	<p>The assessment results helps explaining better to the general public and stakeholders the multiple benefits of LIFE projects in connection to society and the economy with which they interface. The document clarifies key concepts and offers an easy method to implement ecosystem services assessments according to the analytical framework developed under the EU Mapping and Assessment of Ecosystems and their Services (MAES) initiative. Some guidance on how to complete the relevant sections in the KPI Webtool is also given.</p>	<p>https://ec.europa.eu/environment/archives/life/toolkit/pmtools/life2014_2020/ecosystem.htm</p>	<p>The guide has four main components: 1. An introduction to key concepts and methodology. 2. The description of a simple approach to assess ecosystem services applicable to all LIFE projects independently from the method used to quantify them. 3. Guidance on how to complete the relevant sections in the LIFE KPI database. 4. A selection of further resources (https://ec.europa.eu/environment/archives/life/toolkit/pmtools/life2014_2020/documents/life_ecosystem_services_guidance.pdf)</p>
<p>Land Use-based Integrated Sustainability Assessment' modelling platform (LUISA) / GIS based modelling platform</p>	<p>LUISA is developed by Joint Research Centre (JRC) of the European Commission, which is primarily used for the ex-ante evaluation of EC policies that have a direct or indirect territorial impact. At its core is a discrete allocation method that allocates different land uses to most optimal 100m grid cells, given predefined suitability maps, regional land demands and the supply of land in a region. Linked to the allocated land uses are grid cell population counts, which are modelled separately prior to the land-use allocation. The chief outputs that LUISA generates are projected land use, population and accessibility distributions at the 100m grid cell level. Over 50 indicators of land functions are subsequently derived from those chief outputs. Those indicators can inform</p>	<p>https://publications.jrc.ec.europa.eu/repository/bitstream/JRC94069/lb-na-27019-en-n%20.pdf</p>	

	policy effects on themes as varied as resource efficiency, ecosystem services and accessibility.		
Integrated system of Natural Capital and Ecosystem Services Accounting (KIP INCA) / Spreadsheet	KIP INCA aims to develop the first ecosystem accounts at EU level, following the UN System of Environmental-Economic Accounting- Experimental Ecosystem Accounts (SEEA-EEA). The application of the SEEA-EEA framework is useful to illustrate ecosystem accounts with clear examples and contribute to further develop to methodology and give guidance for Natural Capital Accounting.	https://publications.jrc.ec.europa.eu/repository/bitstream/JRC87585/lb-na-26474-en-n.pdf	

Table 7-9. Studies of the impacts of NBS, which show how numerical simulations and modelling can be applied.

NBS	Study	Simulation model	Findings
Air quality	Hirabayashi et al. (2012), Nowak et al. (2014)	<p>i-Tree Eco estimates air pollution removal by trees based on well-established deposition models and hourly air quality and wind speed data from local weather stations</p> <p>i-Tree Eco: https://www.itreetools.org/tools/i-tree-eco</p>	It allows to quantify the structure of, threats to, and benefits and values provided by forests.
	McDonald et al. (2007)	<p>The fine resolution atmospheric multi-pollutant exchange (FRAME) atmospheric transport models designed to predict the impact of NBS implementation of air quality level, e.g. to estimate deposition of nitrogen, heavy metals and the surface concentrations of greenhouse gases by tree planting</p> <p>FRAME: https://frame-online.eu/</p>	Tree planting was simulated by modifying the land cover database, using GIS techniques and field surveys to estimate reasonable planting potentials and predict increasing total tree cover
	Matos et al. (2019)	<p>To model the supply of air-quality regulation based on urban green spaces characteristics and other environmental factors (lichen diversity in urban parks)</p>	A model allows to estimate the supply of air quality regulation provided by green spaces in all green spaces of Lisbon based on the response to the following environmental drivers: the urban green spaces size and its vegetation density. The model helps to map the background air pollution
	Bruse (2007), Simon et al. 2019	<p>Microscale simulations employed for street-scale evaluation with software such as ENVI-MET.</p> <p>ENVI-MET: https://www.envi-met.com/</p>	the newest version of the microclimate model ENVI-met was compared against measured data
	Bagheri et al. (2017)	<p>FRAGSTATS software (Spatial Pattern Analysis Program for Categorical Maps) and a partial least square (PLS) model</p>	The model results indicate that reduction in the area of large green space patches promote air pollution,

		<p>were applied to assess the effects of changes in the pattern of green space on air pollution.</p> <p>FRAGSTATS: https://www.umass.edu/landeco/research/fragstats/fragstats.html</p> <p>Book on PLS: https://doi.org/10.1007/978-3-319-64069-3; https://core.ac.uk/download/pdf/20267242.pdf</p>	<p>suggesting that there is a direct relation between increases in the area of large green space patches and air pollution reduction.</p>
Green roofs for temperature reduction	Bass et al. (2002)	<p>Use of Mesoscale Community Compressible (MC2) model, land use grid cell data, urban canyon model for Toronto, Canada. https://www.coolrooftoolkit.org/wp-content/uploads/2012/04/finalpaper_bass.pdf</p>	<p>A green roof strategy consisting of grass roofs (only 5% of the total city area) reduced temperatures by up to 0.5°C. Irrigating green roofs in the high-density areas produced a much more intensified cooling effect: 1-2°C temperature reduction.</p>
	Chen et al. (2009)	<p>Coupled simulations of conduction, radiation and convection for Tokyo, Japan</p>	<p>Installing grass roofs on medium and high-rise buildings has a negligible effect on the street level air temperature.</p>
	Smith and Roebber (2011)	<p>Weather research and forecasting model (WRF) coupled with an urban canopy model (UCM) applied for Chicago, US</p> <p>WRF-UCM: https://ral.ucar.edu/solutions/products/urban-canopy-model</p>	<p>Vegetative rooftops reduce evening and night-time temperatures by 3°C through increased albedo and evapotranspiration.</p>
	Sun et al. (2012)	<p>Numerical model ENVI-met and verified using field measurements adapted for Taiwan</p> <p>ENVI-MET: https://www.envi-met.com/</p>	<p>The maximum cooling effect of green roofs on ambient air temperature was 1.6°C</p>
Urban land use	Haase et al. (2012)	<p>Combination of system dynamics (SD), cellular automata (CA) and agent-based model (ABM) approaches to cover the</p>	<p>Using the example of urban shrinkage, it highlights the capacity of existing land-use modelling approaches to</p>

		main characteristics, processes and patterns of urban land use and shrinkage in Leipzig, Germany	integrate new social science knowledge in terms of land-use, demography and governance.
	Schwartz et al. (2012)	It presents the ABMland - a tool for collaborative agent-based model development on urban land use change which allows for explicitly coding land management decisions. The software is implemented in Java building upon Repast Simphony and other libraries. ABMland: https://www.ufz.de/index.php?en=37897	ABMland allows for implementing agent-based models and parallel model development while simplifying the coding process. The models include six major agent types: residents, planners, infrastructure providers, businesses, developers and lobbyists. Their interactions are pre-defined and ensure valid communication during the simulation.
	Brown and Castellazzi (2014)	Rule-based models developed for sectoral strategies such as woodland expansion, wind energy, urban development as input for development scenarios using LandSFACTS software and the Integrated Agriculture and Control System (IACS) data in a stochastic process. LandSFACTS: https://www.hutton.ac.uk/research/departments/information-and-computational-sciences/tools/landsfacts/downloads IACS: http://ec.europa.eu/agriculture/direct-support/iacs/index_en.htm .	Such approach of translating scenarios, storylines and policy objectives into spatially explicit realization can be used with any spatial unit (land use or cover polygon, population ward, water catchment) to explore alternative options for land use and the role of particular NBS intervention.
	Hamad et al. 2018	Land use change scenario simulation using a CA-Markov model as one of the commonly used models among many LULC modelling tools and techniques	The models can support to optimize urban land use layout and assist with decision-making
Water management	World Bank (2017)	Modelling NBS for managing freshwater resources	Models for provision of safe drinking water, integrated river basin management, pollution management

	Brunetti et al. (2016, 2017)	Surrogate-based modelling for the numerical analysis of low impact development techniques	The hydraulic behaviour of the green roof, permeable pavement and stormwater filter were analysed by means of a model approach
	Sahukhal and Bajracharya, 2019	The water demand and supply modelling were conducted using the water evaluation and planning (WEAP) model , based on discharge data (can be obtained from Department of hydrology and meteorology). WEAP: https://www.weap21.org/	The performance of the model was assessed through statistical measures of calibration with the root mean square error and coefficient of determination. It allows to create different scenarios important for the analysis regarding the prioritization of demands in the near future for the purpose of sustainability of water resources, due to climate change impacts.
Natural Hazards	Li et al. (2019)	The study used the Soil and Water Assessment Tool (SWAT) module of a GIS platform to simulate the potential of wetlands against flood and droughts SWAT: https://swat.tamu.edu/	The SWAT model was forced with meteorological variables such as daily rainfall, temperature, wind speed, relative humidity, solar energy and it was found that restoration and reconstruction of wetland can reduce the impact of flooding and hydrological droughts.
	Vuik et al. (2016)	Modelling the effect of vegetation on flood wave attenuation using the Simulating WAVes Nearshore (SWAN) model SWAN: http://swanmodel.sourceforge.net/download/download.htm	The study forced SWAN numerical wave model with bathymetry, ocean current, ocean water level, bottom fraction, and wind speed datasets to simulate and evaluate the effect of vegetation on flood wave attenuation. The datasets were retrieved field measurements performed on two salt marshes (cordgrass and grassweed) during the severe storms in the

			Netherlands from November to June 2014
	Wamsley et al. (2010)	Use of the three-dimensional numerical model ADvanced CIRCulation (ADCIRC) to evaluate the role of wetlands in reducing storm surges. ADCIRC: https://adcirc.org/	The study simulated the role of wetlands in reducing storm surges and concluded that wetlands may have capacity to reduce surges, but their effectiveness depends on the surrounding, coastal landscape and the strength and duration of the storm forcing
	Stark et al. (2016)	Use of the two dimensional hydrodynamic model TELEMAC2D to evaluate the role of wetlands during storm tides. TELEMAC2D: http://www.opentelemac.org/index.php/presentation?id=17	The study simulated the potential of wetlands in attenuating peak water level during storm tides. The result of simulation showed that peak water level reduction largely varies among individual flood events and between different locations in the marsh, but the tidal wetlands in combination with dikes provides more effective coastal protection
	Guida et al. (2015)	Combination of hydrodynamic (e.g., 1D HEC-RAS) and geospatial modelling (e.g., HEC-GeoRAS) to simulate the optimal flood risk reduction measures for the Lower Tisza River in Hungary. The main modelling tools and software used in the study are developed by the Hydrologic Engineering Center (HEC) - US Army Corps of Engineers, and available here: https://www.hec.usace.army.mil/software/	The study performed two scenarios such as levee removal and leave seatback to reconnect wetland and found that the wetland reduced flood heights and potential damage to human populations.
	Sang (2020)	Integrating Computational and Participatory Scenario Modelling for Environmental Management and Planning. A range of modelling	Comparative review of a wide range of models from a variety of scientific

Different categories of NBS		approaches such as GIS, optimisation and AI, simulation modelling, remote sensing, citizen science, and geodesign.	disciplines of interest with examples of their use for NBS)
	Nijhuis et al. (2016)	Geodesign as a GIS-based planning and design method , which tightly couples the creation of design proposals with impact simulations informed by geographic contexts. It comprises a set of geo-information technology driven methods and techniques for planning built and natural environments in an integrated process	It allows project conceptualization, analysis, design specification, stakeholder participation and collaboration.
	Steinitz (2016)	Geodesign is proposed as an iterative design method that uses stakeholder input, geospatial modelling, impact simulations, and real-time feedback to facilitate holistic designs and smart decisions.	It was shown how geodesign bridge geo-information technology, spatial design and planning. It showcases the ongoing effort to employ the potential power of using GIS to link different model types and ways of designing to make better plans.
Ecosystem services provided by NBS	Nelson and Daily (2010), Nelson et al. (2009)	Modelling multiple ecosystem services , biodiversity conservation, commodity production, and tradeoffs at landscape scales using spatially explicit modelling tool, Integrated Valuation of Ecosystem Services and Tradeoffs (InVEST) InVEST: https://naturalcapitalproject.stanford.edu/software/invest	It allows to predict changes in ecosystem services, biodiversity conservation, and commodity production levels. InVEST was applied to stakeholder-defined scenarios of land-use/land-cover change in order to help making natural resource decisions more effective, efficient, and defensible.

7.6 Mimicking the impacts of NBS: how laboratory data can help

Laboratory experiments can help assessing causal relationships based on the observation of the direct effects of NBS on a small-scale with rapid, and short-term ecological/environmental processes and society. It can be assumed that if a laboratory study is well-controlled, the factors that can cause the difference can be reliably identified. In contrast, all confounding factors cannot be ruled out in observational studies (Yuan et al., 2017). Thus, laboratory studies are generally assumed to mimic long-term impacts of NBS and can be useful when trying to assess ex-ante the performances of a NBS intervention.

For example, a series of laboratory flume experiments has been conducted within the EU-H2020 Project OPERANDUM in order to study how different soil surface conditions (smooth, compacted and non-vegetated surface, soil vegetated with standard herbaceous plants vs specifically selected deep-rooted herbaceous plants, etc.) may affect or improve the erodibility resistance of the riverbank of Panaro River (IT) over long term. The studies were antecedent to the actual NBS deployment and guided the choice of the NBS most appropriate to help preventing levee failures and inundations at this site.

In the context of research with human, a novel technique to measure the individual's psychophysiological response to environmental stimuli is represented by Immersive Virtual Reality (IVR). IVR involves the use of virtual devices that allow the individual to experience a simulated natural environment in a multisensory way. For example, the response on the induced stress of virtual environments at different degrees of biodiversity (Schebella et al., 2020) and the aesthetic value and perception of beauty of a virtual environment with multiple natural features (Vercelloni et al., 2018) can be assessed with this technique. During the NBS planning stage, IVR pilot studies could provide guidance on how to maximize NBS beneficial effects on human health and well-being.

Laboratory based simulation represents a powerful means of generating data on NBS performance. This section presents examples of how laboratory experiments can provide insights into real-world NBS performance.

7.7 Engaging the community in the data collection process: citizen science and its role in NBS monitoring

Citizen science has great potential in monitoring and evaluating NBS impact. It can represent a cost-effective way to gather data on a larger numeric and/or geographical scale than would otherwise be feasible. In addition to this, citizen science approaches can offer numerous benefits for society compared to other types of data generation, including:

- Great paybacks to both society and growing areas of science (such as nature-based solutions), including raising awareness of local risks and opportunities;
- Engagement and empowerment of the public by giving them a voice in science, policy and decision making;
- Societal benefits such as social cohesion, integration, and reconnection of communities with nature.

Citizen science has risen in popularity due to these numerous co-benefits for citizens. Citizen science-based data generation can also represent added value for local authorities: Although there can be a cost associated with running such activities, this can represent value for money compared to the economic cost of alternative monitoring methods, particularly if the added social benefits are factored into the 'value' of the approaches.

Citizen science is increasingly recognised as an effective way to generate substantial datasets that would not otherwise be possible using traditional scientific approaches. This section explores the benefits of such approaches and discusses examples of how communities can be engaged in data generation.

Whilst citizen science approaches are becoming increasingly adopted, they can also come with challenges. This includes challenges in relation to the quality of data generated. For example, evaluation methods may need to be basic for some indicators compared to the complexity that can be achieved through the use of specialists. Other challenges to wider adoption of citizen science projects include the need for training participants, and

associated problems in retention following training, challenges in validating data quality and reliability, and eliminating sampling bias (Pocock et al., 2014; Lukyanenko et al., 2016).

Despite these challenges, citizen science approaches are increasingly being adopted, including in the evaluation of nature-based solutions. For example, citizens have been actively involved in data collection for earth observation, ground measurements, and survey data. Citizens have contributed by using technological advancements such as smartphones, low-cost sensors, and social media to record such diverse parameters as air quality, bird and butterfly counts, water quality, recreational value of greenspaces, and risk management. Data collected from such processes may represent an entire dataset or can be used as added value or for validation purpose for data collected using other methods. The following tools are being successfully and broadly applied for citizen science data collection.

Crowdsourcing encompasses obtaining a large amount of data from a crowd of people (or more often the general public) that shares information, voluntarily. This is often done through the internet and/or using smartphones. Each single data supplies is then aggregated to generate a cumulative dataset. Due to the

large number of contributors, crowdsourcing requires an easy to use framework, instructions and communication setup to ensure engagement.

Crowd sensed data describes data which are specifically collected and shared by a large number of citizens through different types of devices, such as mobile phones, wearable sensors or vehicles (e.g., sensors mounted on bicycles to measure air temperature or air quality parameters). Whilst this method of data generation also requires participant permission, it can be less active than crowdsourcing, with data often collected passively through smartphones and sensors rather than active input by participants. This can include environmental factors such as ambient light, noise, location data, movement data, and air quality. Similarly to crowdsourcing, this method of participatory sensing can support the monitoring process over a range of spatial scales from small to large (Guo et al. 2015). It has several advantages such as low-cost sensing or high amount of data collected. However, the use of crowd sensed data can be constrained by issues such as sensor accuracy and participation of citizens.

Volunteered geographic information (VGI) is a type of crowdsourced information where data have spatial information attached. The crowdsourced data are usually collected in, or converted to, a mapped form with spatial (and temporal) dimensions. Leading examples for this are *OpenStreetMap* (OSM) or the use of online mapping and social media such as Twitter to communicate information about natural disaster events (e.g., hurricanes and earthquakes).

These and other citizen science approaches have been tested and implemented by various NBS projects. This includes the EU-H2020 project OPERANDUM in which citizen science approaches were integrated into the NBS implementation and monitoring. Indeed, the community neighbouring the NBS were engaged in the co-design of the nature-based solutions, and were actively engaged in data co-creation processes. At one of the OPERANDUM NBS sites (Finland), citizens measured snow depth with traditional and low-cost measurement instruments during the winter, while water quality and visibility as well as precipitation were measured throughout the year. The measurements were then shared in a web application which is linked to the database of the national weather service (where the data were compared and combined with remote sensing data). OPERANDUM also uses OSM data to derive information about critical infrastructure for the risk modelling. Furthermore, the project offers a web application for NBS crowdsourcing which engages the citizens to post information (through their mobile phone or the internet) about NBS projects implemented in the place where they live or more in general about NBS which they have knowledge of (Figure 7-4).

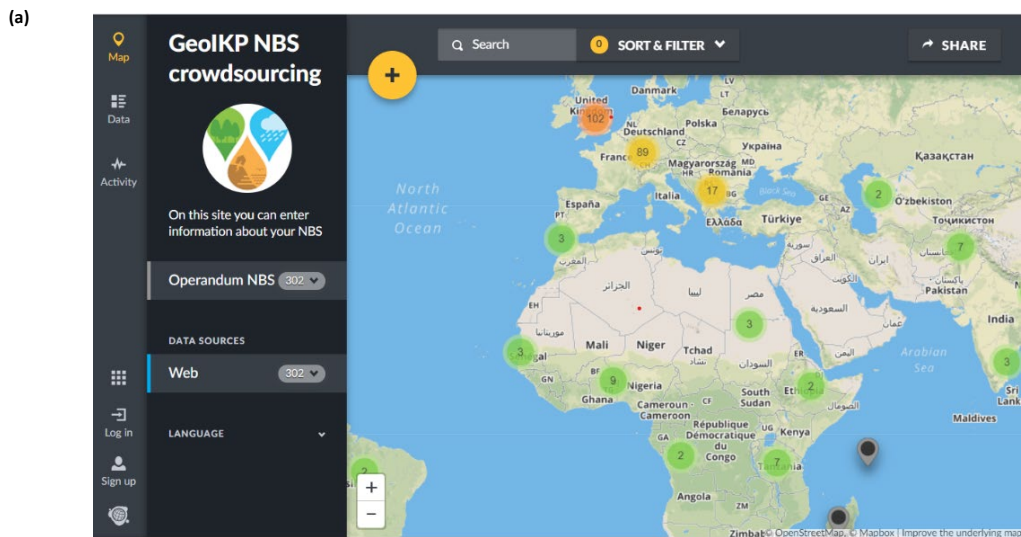

Figure 7-5. (a) Snapshot of the crowdsourcing app used in the EU-H2020 project OPERANDUM to engage the community in sharing information on NBS (source: <http://crowd-geokip.kajoservices.com/views/map>); (b) citizens involved in the NBS co-deployment and monitoring at Catterline (UK): on the left, residents helping to measure the permeability of the soil at their front gardens; on the right, residents fixing geo-grid on slope to prevent erosion and shallow landslides (source: EU-H2020 project OPERANDUM; photo credit: Alejandro Gonzalez-Ollauri).

7.8 Data integration

In previous sections, different data collection strategies have been explored for the purpose of fulfilling the data requirements for NBS monitoring and assessment. Data collection is however only the first steps in conducting a NBS assessment, since data gathered from different sources will often have to be analysed in combination and integrated together in order to provide valuable insights on the impacts and co-benefits of a NBS intervention in comparison to a baseline scenario.

In that respect, spatial modelling and spatial analysis may represent an effective strategy for the monitoring and/or planning of NBS, since it allows to integrate,

analyse and visualize different data types. For example, using remote sensing data under a GIS environment, it is possible to provide geo-referenced information on the shape, size and distribution of different land-use classes of the urban environment (Herold et al., 2005). This allows monitoring of urban growth (area change, structures, land consumption, soil sealing) and land cover/land-use changes (loss of agricultural area, wetland infringement, loss of areas important for biodiversity, spatial distribution of inner-urban green and open spaces and natural areas) as well as mapping of various environmental parameters (data important for urban climate, access to and distribution of open space, calculation of sealed surfaces).

High resolution remote sensing data can be combined with measured pollutant concentrations in a GIS environment, to map the removal of PM₁₀ and ozone by urban trees and estimate the physical removal of pollutants by trees at specific locations. Various types of observations are usually used in combination with (and/or as input data of) modelling tools. Besides, results from 3D numerical models (e.g., Envi-met model, <https://www.envi-met.com/>) and other modelling techniques can be also usually imported in a GIS environment and combined with RS, EO and ground observations for planning purposes or for analysing present/future impacts of an NBS intervention. See Table 7-10 for more examples⁶¹.

Typically, evaluation data is not generated in isolation, and there is a need to analyse data using integrated approaches. By doing so, it is possible to generate greater insights than are the sum of the individual data sources. This section explores different data integration approaches, providing specific examples, and data sources that can support data integration and interrogation.

⁶¹ Another relevant example of data integration through digital mapping (e.g., remote sensing, GIS) is provided in EKLIPSE (<http://www.eclipse-mechanism.eu/home>)

Table 7-10. Examples of data integrations used in NBS projects.

Project	Approach	Web link
Naturvation	Remote sensing, satellite imagery and digital orthophotos together with Geographic Information Systems (GIS) used to develop a digital elevation model and a digital surface model. Input data: qualitative and GIS data. Output data: quality of life, tree coverage; spending time in city parks, gardens, and open spaces.	https://www.naturvation.eu/
	Deterministic model which uses remote sensing of greenness as well as surface sealing to estimate recreation supply. Input data: Remote sensing data, NVDI and surface sealing. Output data: Spatially normalized minimum of green space provision per person suggested by the city administration (m ² per Block; m ² /m ²)	
	A model based on remote sensing – MODIS NPP. Input data: allometric equations, net photosynthesis (PSNnet), average growths in diameter of specific tree species, trees diameter at breast high. Output data: Net primary productivity kg C per tree and year	
IMPRESSIONS	Mapping land use, ecosystem functions, and ecosystem services using cutting-edge remote sensing and machine learning techniques	http://www.impressions-project.eu/
	A coordinated effort to integrate and analyse a higher quantity and quality of CO ₂ and CH ₄ data, from in situ and remote sensing observations encompassing atmosphere, land and oceans.	
URBES	Remote Sensing of Urban Ecology (EO sensors, modelling algorithms)	https://www.biodiversa.org/121
	Spatial and remote sensing data analyses	

URBACT	Remote sensing (production of high spatial resolution, including the urban atlas, built-up areas, and air pollution) and so-called big data are used to compare and benchmark cities.	https://urbact.eu
OPERANDUM	Remote sensing data to monitor land surface parameters, Observation from Copernicus Land, Marine, Atmosphere, Climate Change, Emergency Services, NBS monitoring sensors installations (e.g., monitoring green roofs in Dublin), GHSL population distribution, EUROSTAT socio-economic indicators to compute the risk indicators, Local and EU scale hazard information at corresponding different return levels scenarios and critical infrastructure as an input to risk modelling, Local and continental ERA40 data reference climate data and CORDEX climate projections to assess different NBS scenarios for present and future climate.	https://www.operandum-project.eu
URBAN GreenUP	<p>Mapping the removal of PM₁₀ and ozone by urban trees by combining high resolution remote sensing data with measured pollutant concentrations to estimate the physical removal of pollutants by trees.</p> <p>Mapping and assessing the contribution of urban vegetation to microclimate regulation, deriving a map of Land Surface Temperature based on Landsat 8 Data, using a model of Du et al. (2015), aggregating Land types to assess the changes in average temperature.</p> <p>Mapping urban temperature using remote sensing (split window algorithm) and modelling techniques for assessing urban temperature and the indicator for microclimate regulation.</p>	https://www.urbangreenup.eu/about/about.kl
PLUREL	<p>Remote sensing and GIS for sustainable urban development science to provide geo-referenced information on the shape, size and distribution of different land-use classes of the urban environment. Main applications:</p> <ul style="list-style-type: none"> • Monitoring urban growth (area change, structures, land consumption, soil sealing; • Monitoring land cover/land-use changes (loss of agricultural area, wetland infringement, loss of areas important for biodiversity, 	www.plurel.net

spatial distribution of inner-urban green and open spaces and natural areas);

- Mapping of environmental parameters (base data important for urban climate, access to and distribution of open space, calculation of sealed surfaces).

Another relevant example of data integration is represented by the use of Big Data in the context of NBS, where they can be helpful in decoding the complex relationship of socio-environmental cultural domain. Although there are not yet well-defined and generalized indices to be used (hence caution should be used in handling Big Data for NBS monitoring), appropriate measures could be constructed by combining different data types and data sources, such as (i) spatial data combined with health data on illness incidence, and (ii) spatial data on population density and social demographic indicators with a view to analyse climate change (Frantzeskaki et al., 2019). In that respect, a valuable source of Big Data is represented by the social media data, which can help identifying new habits and needs as drivers of uncommon way of life (Ilieva and McPhearson, 2018). Another source of big data is the data generated by consumer behaviour inspired by sustainable choices. Under this perspective, spatial, economic, preference and temporal data can be aggregated and analysed.

As further discussed in Section 7.9, the establishment of a baseline also required the integration of different data types. In this case, spatial data using remote sensing, earth observation and GIS technologies are usually combined with non-spatial data from field surveys and other sources if they are secondary data. In the EU-H2020 project UNaLab, for example, non-spatial datasets including both qualitative (surveys, questionnaires and scoring, etc.) and quantitative (environmental, social and economic statistical and legacy datasets) data were completed with spatial information for the evaluation of KPIs and the establishment of the baseline conditions.

The non-spatial or attribute or characteristic data typically include demographic variables, socioeconomic conditions and other non-spatial properties such as environmental culture or human/individual behaviour (cf. Sections 7.3–7.4). They are relevant not only for describing the status quo and planning the future strategy, but for identifying needs too. In the EU-H2020 project URBiNAT, the well-being, social cohesion and economic-social aspects of the project city have been analysed through collection of several types of non-spatial data. Other examples of how various types of non-spatial data can be combined for the purpose of NBS assessment are provided in Table 7-11.

In some cases, integrated datasets of relevance for NBS monitoring and baseline construction are also readily available from external sources. An excellent example is the Global Human Settlement Layer (GHSL) platform (<https://ghsl.jrc.ec.europa.eu/download.php>). GHSL produces global spatial information about the human presence on the planet and its changes over time. This is in the form of built up maps, population density maps, settlement classification maps and database on urban centres (see Table 7-12). The framework uses heterogeneous data including global archives of satellite imagery, census data, and volunteered geographic information and produces free information layers and knowledge reporting about the presence of population and built-up infrastructures at European and Global scales (Pesaresi, 2018).

Table 7-11. The use of non-spatial data applied in the NBS projects.

Project	Mode of acquisition	Main application	Source
CONNECTING Nature	Gathering knowledge from different stakeholders through surveys, questionnaires, workshops, reflexing monitoring webinars and round tables; co-creation and co-design events with policy makers and the communities-of-interest; statistical data and policy documents; set of non-spatial human-wellbeing and economic indicators (e.g., social cohesion, general wellbeing and happiness, levels of aggressiveness and violence, additional funding secured for NBS, etc.)	To identify new synergistic data-gathering techniques that make use of the latest available technologies and allow representation of traditionally under-represented groups in urban policymaking	https://connectingnature.eu/our-resources
UNaLab	Qualitative data (e.g., surveys, questionnaires and scoring) and quantitative data (environmental, social and economic statistical and legacy datasets)	To establish the baseline conditions, for evaluating the KPIs and complementing the spatial information with non-spatial attributes	https://unalab.eu/en/documents/d31-nbs-performance-and-impact-monitoring-report
EKLIPSE	<p>“Air Quality” indicators developed within the EKLIPSE Working Group impact evaluation framework.</p> <ul style="list-style-type: none"> • non-spatial indicators of gross quantities: annual amount of pollutants captured by vegetation; • non-spatial indicators of net quantities: net air quality improvement (pollutants produced—pollutants captured + GHG emissions from maintenance activities); • non-spatial indicators of shares: share of emissions (air pollutants) captured/sequestered by vegetation; 	To assess ecological, economic and social value of NBS	http://www.eclipse-mechanism.eu/apps/Eclipse_data/website/EKLIPSE_Report1-NBS_FINAL_Complete-08022017_LowRes_4Web.pdf

	<ul style="list-style-type: none"> the economic value of air or water purification measured using avoided costs for health care or replacement costs for artificial treatment 		
OPERANDUM	<p>Surveys on perception of NBS in local communities</p> <p>Surveys on implementation of the NBS in the Open-Air Laboratories</p>	Asses the acceptance of the NBS by local communities to provide qualitative input into efficacy and co-benefits and societal impacts of the NBS. Monitor progress of the NBS installation to synthesize practical cook-books of NBS implementation	http://operandum-project.eu
NATURVATION	Urban Nature Atlas (UNA), a database and detailed characterization of 1000 NBS in 100 European cities; set of social indicators identified for the assessment of NBSs social impacts especially related to well-being and human health, education, social interaction, social justice, safety, job creation, urban green space accessibility and availability	To assess economic and social value of NBS	https://naturvation.eu/atlas
GREEN SURGE	on-spatial quality data gathered through interviews, questionnaires, and then used in public participation geographic information systems (PPGIS) and hedonic pricing	To support decision-making on urban green space-management, e.g. to assess how residents with different backgrounds value and use green areas across the cities	https://greensurge.eu/
Nature4Cities	Survey among local residents on how green space can contribute to quality of life and also to regional attractiveness	To develop a complimentary assessment tool on quality of life, to evaluate the environmental, social and economic benefits associated to NBS	https://www.nature4cities.eu/results
URBiNAT	Survey through validated questionnaires in multiple cities	To assess the level of well-being across the project cities	https://urbinat.eu

The GHSL database (in particular the Urban Centres Database UCDB) can be used as data source for assessing several indicators related to SDGs and in particular the indicators of success of nature-based solutions in cities both at the European and Global scale. In the EU-H2020 project OPERANDUM, for example, GHSL data are in combination with hazard information (e.g., flood extent) to derive the flood risk indicators such as population affected. Another example is the possibility to use GHSL datasets to investigate changes in the amount of greenness within cities in the periods centred on the years 1990, 2000 and 2015 (Corbane, 2018). Of relevance to indicators framework for NBS, GHSL multitemporal dataset on built-up (GHS-BUILT) and population (GHS-POP) can also be used to provide a quantitative assessment of changes in the Land Use Efficiency (LUE) indicator for more than 10 000 cities between 1990 and 2015 (Schiavina et al., 2019). This measures the land consumption rate to population growth rate and can be used as a proxy for land take. The LUE is recommended for estimating SDG indicator 11.3.1 which requires data on the spatial extent of the settlements and the dynamics of their population.

Table 7-12. Summary of main GHSL datasets at global and European Scales. GHSL datasets are described in detail in Florczyk et al. (2019). All datasets are freely accessible for download from the GHSL website managed by the European Commission: <https://ghsl.jrc.ec.europa.eu/download.php>

Dataset	Semantic	Format	Resolution	Date	Main input data source
GHS-BUILT	Built-up area and their densities at global scale	Raster	30 m–250 m–1 km	1975–1990–2000–2015	Satellite imagery
GHS-POP	Density of population at global scale	Raster	250m–1km	1975–1990–2000–2015	GHS-BUILT Census data GHS-BUILT GHS-POP
GHS-SMOD	Classification of Human settlements: urban centres, urban cluster, rural areas at global scale	Raster	1 km	1975–1990–2000–2015	Census data
UCDB	Description of spatial entities corresponding to accordingly to a set of multi-temporal thematic attributes at global scale	Shapefile Excel file	1 km	Different time depths with a maximum of 40 years	GHS-BUILT GHS-POP GHS-SMOD

					Other sources
FUA	Functional Urban Areas corresponding to urban centres and their commuting zones at global scale	Shapefile	1 km	2015	GHS-POP UCDB Global friction matrix

Table 7-12 provides a summary of the main datasets available in the GHLS suite, which includes, among others, the following data products.

1. The European Settlement Map (ESM_2015) which is a new spatial raster dataset mapping human settlements of 2015 in Europe. It is published in two layers: (a) Built-up areas at a spatial resolution of 2 meters, (b) Classification of the built-up areas into residential and non-residential at a spatial resolution of 10 meters.
2. The GHS-FUA Functional Urban Areas. This dataset delineates the spatial entities representing the commuting area of the Urban Centres of 2015 [9]. The dataset is provided in GeoPackage format.
3. The Urban Centres Database (UCDB) in which more than 10 000 individual cities are characterised by a number of variables (several are multitemporal) describing the geography (e.g., temperature, elevation), socio-economic characteristics (e.g., population density, built-up surface), the environment (e.g., greenness, CO₂ emissions), potential exposure to natural hazards (e.g., exposure to floods, heatwaves) and SDG indicators. The UCDB is provided in the form of vector shapefiles with attributes describing each spatial entity and in the form of an excel table with detailed description of each attribute. Furthermore, there is a dedicate webpage (<https://ghsl.jrc.ec.europa.eu/ucdb2018Overview.php>) which allows you to explore the different thematic attributes for each city (Figure 7-5).

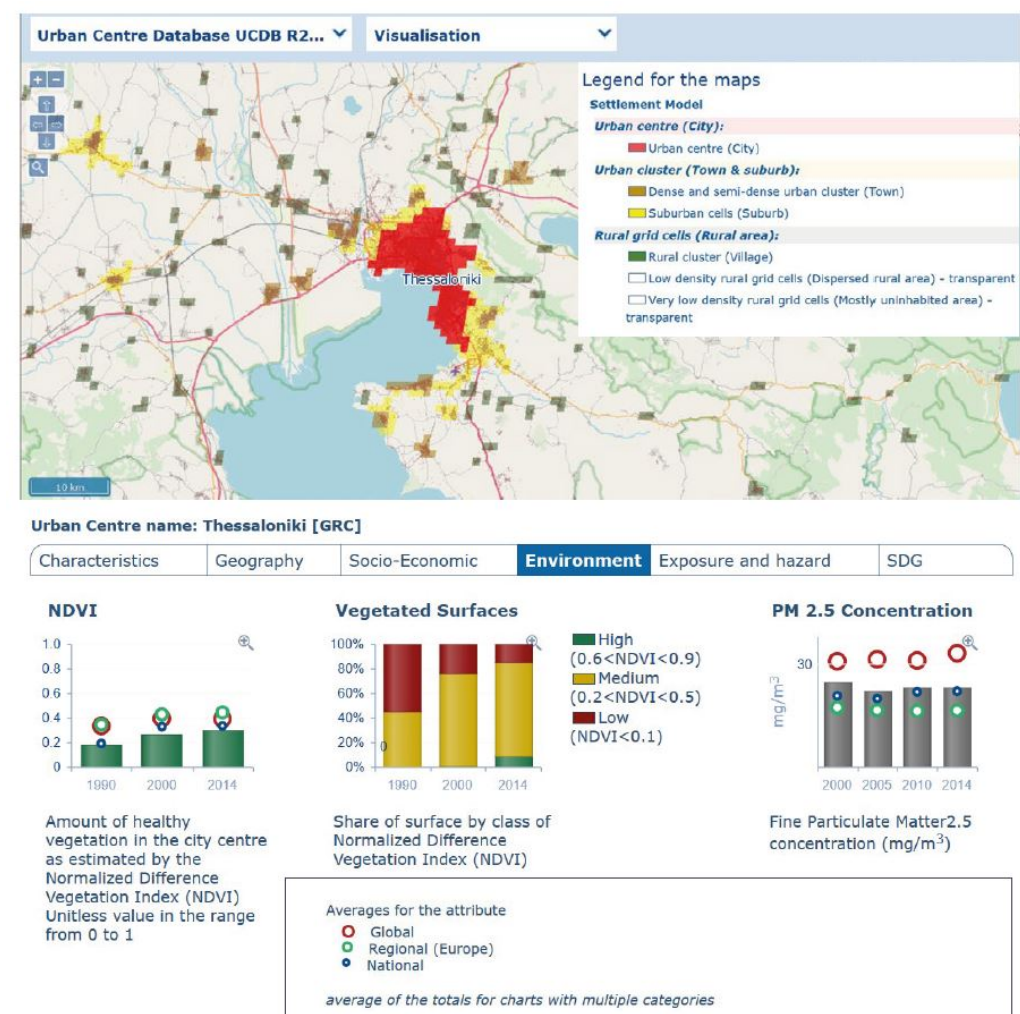

Figure 7-6. Example of the UCDB visualization for the urban centre of Thessaloniki (GRC) showing the environmental attributes.

7.9 Baseline Assessment

Baseline data collection is essential for any future evaluation of NBS performance. Baseline data should essentially be able to convey both the “state of play” (initial situation, from the social, economic, environmental points of view) as well as temporal and spatial trends of parameters, which will be further monitored and assessed throughout the project implementation and at its conclusion. The assessment is related to the performance evaluation of the NBS itself, and it is not aimed for the comparison between the NBS intervention and other grey or hybrid solutions dealing with the same issues. Especially for nature-based solutions, identifying initial trends allows an understanding of how the baseline conditions may change in the absence of the proposed actions, and thus for the definition of “business as usual” scenarios. Baseline data may indicate, for

example, that a particular peri-urban habitat may have significantly shrunk in the last ten years and is continuing to shrink at an accelerated rate. Without an understanding of this trend, conclusions about the results of any action and its impact on the habitat would be erroneous. In fact, comparing the outcome (e.g., in year 2025) with the initial state (2020) – rather than with the “business as usual” scenario (for the year 2025) – would be flawed in this case.

Of critical importance to the value of data generated is the establishment of a baseline against which impacts of NBS implementation can be measured. This section explores the characteristics of an evaluation baseline, discussing the components of a baseline that need to be considered when planning NBS evaluation.

For physicochemical constituents, the baseline conditions should ideally be established prior to NBS implementation. In cases when the baseline measurements are not available, a site with similar conditions could be employed as a “proxy baseline”. The latter approach naturally has its limitations in the representativeness as the reference site will not have the same exact conditions, and the results may be biased. Special regionalization methods could be employed to minimize the representativeness issues (e.g., selection of multiple sites with available measurements having similar characteristics to the NBS implementation site, in order to have a more representative sample). Spatial data can be employed for assessing the baseline conditions when combined with in situ measurements. However, historical and statistical datasets may have variable spatial and temporal resolutions, and they may not be consistent within a single urban area. Data aggregations or modifications may be necessary to overcome these challenges in applying the available datasets for pre-NBS baseline establishment.

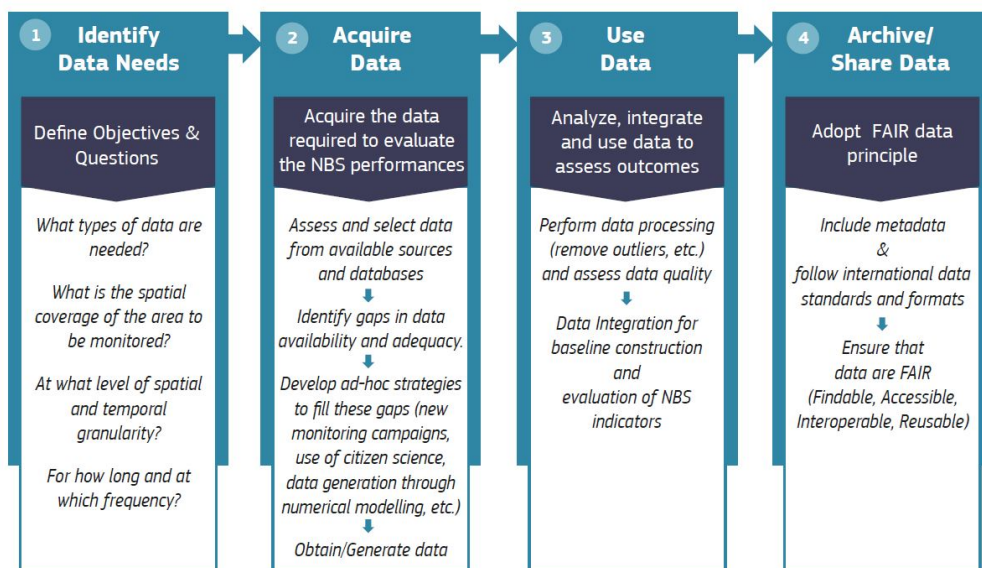

Figure 7-7. Key steps in the development of a robust data management plan to ensure data quality, data standards and data accessibility.

The lack of baseline data and/or the fact the baseline data collection is not always envisaged in an NBS project and often depends on (Bamberger, 2006):

- Lack of awareness on the importance of baseline data for NBS impact assessment;
- An inadequate and insufficient program planning and oversight;
- Budget/Time/ Political constraints;
- Delays in the administrative procedures (recruiting and training of the staff, acquisition of the necessary materials, commissioning consultants etc.) before the beginning of the baseline study;
- Evaluation not commissioned until late in the project cycle;
- Difficulties in identifying common data groups for the comparison;
- Lack of availability or low granularity of initial data.

Table 7-13 provides general guidelines on how to determine whether a baseline study is necessary, and to what extent (International Federation of Red Cross and Red Crescent Societies, 2013).

Table 7-13. Necessity of baseline data studies (based on the guidelines provided by the Planning and Evaluation Department (PED) of the International Federation of Red Cross and Red Crescent Societies).

Baseline study	Rationale
No study needed	<p>Sometimes it is not necessary to study and collect baseline data because they are already known, e.g.:</p> <ul style="list-style-type: none"> • The indicator value may be known to be “0” prior to the project start (for instance “none of the communities have been involved in NBS co-implementation before the project”). • The data could be available from other sources (i.e., from secondary data).
Shallow Study Needed	<p>The number of baseline data and the methods to measure them are restrained in time, capacity and resources because they are available from other sources, therefore easily collectable, or it possible to replace expensive household surveys with less costly qualitative methods such as individual / group interviews or online surveys. For example, “Perceived neighbourhood green space safety”, assessed via individual questionnaires using random sampling techniques.</p>
In-depth Study Needed	<p>Sometimes, it is necessary to have a more rigorous baseline study. Examples could be climate resilience improvement projects in which it is foreseen a renovation of the buildings' roofing, that could require the collection of data regarding energy and carbon emissions savings (i.e., from reduced building energy consumption (kWh/y and t C/y saved)),</p>

	the development of specific questionnaires to be submitted to residents and a statistical analysis of the data.
Reconstruction of Baseline Data	When the baseline data study is needed but it was not conducted prior or near to the project beginning, a reconstruction of the baseline measurements is needed. The greater the time lag between the delivery of the project activities and the baseline study, the more likely the project will have a measurable effect on the indicators, leading to an underestimation of its impacts on the context.

Nevertheless, assessment of project outcomes and impacts should not be confined strictly to baseline and final analyses, because NBS projects may yield cascading results or externalities during the actual implementation. For example, in the cases in which a project implies an improvement of the green areas present in the neighbourhood, speculators may begin to invest in land ownership and families can decide to start improving the quality of their property. If the baseline data study is postponed for a long time, many of these important changes could be omitted.

If baseline data need to be reconstructed, there are several approaches which can be used to achieve a discreet result (Bamberger, 2010):

- Secondary data: checking documentary sources, such as annual reports of governmental agencies;
- Administrative data: feasibility and planning studies made prior to an intervention on a specific territory, application / registration forms, etc.;
- Recall: technique based on surveys or individual / group interviews, particularly useful for recalling major events or impacts of a new service (including ecosystem service), albeit subject to biases;
- Key informants: in-depth interviewing and involvement of external stakeholders (representatives of a society or a specific target group) which combines "factual" information with a particular point of view, offering a different perspective.

It should be, however, noticed that no data collection method is free from the possibility of inaccuracy. Due to this, the above-mentioned methods, and especially the ones relying on surveys and interviews, are usually accompanied by the Triangulation method. This allows to verify the results against data collected from other sources, to confirm accuracy and precision of the reconstructed baseline. Another term often encountered in baseline studies is Comparison (or Control) Group. It refers to a group of units (e.g., persons; census cells; households) that has not been affected by the project impacts and serves as a source of counterfactual causal inference (Maldonado and Greenland, 2002). The big challenge in this case is selecting a well-matched baseline comparison group.

A critical point whose importance is sometimes overlooked is the fact that spatial analysis of data for baselines requires *a priori* knowledge about both the data as well as the underlying processes (Csillag and Boots, 2005). This includes being aware of the possibilities and limitations of the various spatial statistics available, but also knowledge of existing urban policies, spatial plans and regulations which allow contextualization of findings.

Baseline studies, for example for Strategic Environmental Assessment (SEA, <https://ec.europa.eu/environment/eia/sea-support.htm>), include reviews of the policy context and a collection of detailed evidence on the state of the environment (context) in which a nature-based solutions project will deploy its activities.

Lack of statistical data can hinder the creation of a sufficiently robust baseline profile for one or several key NBS assessment domains, potentially leading to a limited understanding of pre-conditions and potential. One way of mitigating this risk, tested in proGIreg, was to include a “long list” of spatial indicators, ensuring that even though cross-city comparability may be limited, the key assessment topics are still characterised by a minimum of two data sets, selected from the most commonly used datasets of statistical offices across Europe. These have been grouped in key assessment domains, and descriptors (Table 7-14), with each descriptor further expanded through a set of indicators and datasets – 70 in total.

Based on the proGIreg experience, there are two recommendations which can be provided for the purpose of developing baseline analyses. The first is the allotment of sufficient time for data collection, as a task in itself which often involves sending out data requests to other institutions (e.g., regional offices). Beyond data availability, a key factor of success is the capacity of the cities themselves to work with data, and the need for close connection between different stakeholders involved in data management, analysis, policy makers, and the local communities (as both beneficiaries as well as data providers). This is likewise a process which should be planned carefully in time.

Table 7-14. Example of baseline data requirements (from EU-H2020 project proGIreg. More details can be found in Leopa and Elisei, 2020).

Assessment domain	Subdomain/descriptor and example data
1. Socio-Cultural Inclusiveness	1.1 Demographics (e.g., Population growth rate, migration rate)
	1.2 Social and cultural inclusiveness (e.g., Material deprivation rate)
	1.3 Education and access to social and cultural services and amenities
	1.4 Housing (e.g., Density of the built environment)

2. Human health and wellbeing	2.1 Health (e.g., Incidence of cardio and respiratory diseases, obesity rate)
	2.2 Wellbeing (e.g., Green space per capita, urban safety)
3. Ecological and environmental restoration	3.1 Land use and Vegetation
	3.2 Climate/Meteorological data
	3.3 Air Quality
	3.4 Soil
	3.5 Water
	3.6 Urban environment
4. Economic and labour market benefits	4.1 Market labour and economy indicators (e.g., Number of green jobs)
	4.2 Gentrification indicators (e.g., Average household disposable income, property values)
	4.3 Tourism and attractiveness indicators (e.g., Expenses in local retail business)
	4.4 Taxes, Investment and Financing (public investment programs)

7.10 Data adequacy and related aspects

Adequate *collection, management* and *use* of data is foundational for a holistic assessment of NBS performances. Challenges and requirements related to data needs and their collection addressed in the previous Sections emphasise the importance of generating reliable data. Table 7-15 lists the principal aspects determining the quality of analysis derived from the main data collection and generation methods in terms of potential error sources and their prevention and elimination.

This section discusses what is adequate in terms of data collection, management, and use. This includes a focus on data granularity, bias, accuracy, typical errors, and ways to prevent error.

This section focuses on the most common and critical challenges encountered when using data. Data utilization challenges generally fall into three categories: data quality, data appropriateness and data accessibility. Gaps and irregularities in spatial and/or temporal data series, as well as data accuracy and

other error sources, affect the quality of data, while data granularity and resolution define if a dataset is appropriate with respect to the target of investigation. Together with accessibility and other key characteristics discussed at this end of this section, these aspects determine the overall adequacy of a dataset.

Table 7-15. Data accuracy, typical errors and ways to prevent errors for different NBS data generation and collection methods.

NBS data collection/generation method	Data accuracy	Typical errors/biases	Ways to prevent errors
Observational data (Sections 7.1-7.2)	Depends greatly on data collection or generation methods, e.g., granularity and resolution of the measurements, quality of measurement systems, measurement scale or specification, and selection of samples.	<p>Manual sampling data can contain uncertainties due to spatial and temporal heterogeneities or low-quality measurements.</p> <p>Random selection of samples may cause inaccuracies.</p> <p>Inadequate baseline or reference definition.</p> <p>Ambiguous or erroneous results when aggregating historical or legacy datasets with observational data (e.g., Scholes et al., 2013).</p> <p>Satellite-derived images can contain shadows due to the size of the frame or be of low spatial and temporal resolution.</p>	<p>Standardized sampling methods and protocols, appropriate measuring intervals, detection limits and calibration of the measurement instruments (e.g., Pepper, Brusseau, and Artiola, 2004).</p> <p>Accurate baseline or reference definition.</p> <p>Statistical manipulations, such as aggregation (scaling-up) of dis-aggregation (downscaling) of datasets with varying granularity, must be exercised cautiously (e.g., Scholes et al., 2013)</p> <p>Satellite observations must be validated against and complemented by ground measurements and/or other high-resolution RS-platforms such as drones or aircraft-based (e.g., Orgiazzi et al., 2017).</p>
Surveys and census (Sections 7.1 and 7.3)	Survey data are usually collected from a group of participants which will represent a larger group. Accuracy of the data depends e.g. on the representativeness of the participant group and sample size. Statistical analysis can be used to estimate the accuracy.	<p>Poor representativeness or small size of a research group. Data from qualitative survey can be complex.</p> <p>Constraints and limitations in availability of specific or updated statistical data.</p>	<p>Choosing data collection sources/methods which produce the desired information.</p> <p>In quantitative surveys, verifying quality, relevance, simplicity, accuracy and clarity of the questionnaire.</p> <p>In qualitative surveys, choosing proper approach and identifying suitable strategies for data collection.</p>

<p>Laboratory experiments (Sections 7.1 and 7.6)</p>	<p>Laboratory experiments can control most of the variables under study and can offer the most accurate analysis methods. Representativeness of the samples and quality of the analysis define accuracy of the data.</p>	<p>Samples are not representative for the desired research subject (e.g., samples are not in their natural state) or the laboratory experiment is not mimicking the real-life situation or long-term effects.</p> <p>Instrumental or human errors.</p>	<p>Verification of the methods to mimic real-life situation and long-term effects.</p> <p>Well-controlled, standardised measurements with high-quality and calibrated instruments.</p> <p>Automated analysis can eliminate human errors.</p>
<p>Numerical simulations and modelling (Sections 7.1 and 7.5)</p>	<p>Models are simplifications of the real-world systems (Grützner, 1996) and some uncertainty should be accepted.</p> <p>The accuracy of the model depends mostly on the amount of accuracy and of the initial data, quality of the model, and skills of the model user (Government of South Australia, 2010).</p>	<p>Limitations and uncertainties related to the technical or mathematical structure on which the model is built.</p> <p>Inadequate calibration and/or validation due to low-quality or limited initial data.</p> <p>Inaccurate assumptions and/or approximations in the model.</p> <p>Inappropriate use of the model.</p>	<p>Use of high-quality models to address the specific, desired research questions</p> <p>Models are calibrated and verified against observational (field or laboratory) data to ensure the accuracy of results and the overall uncertainty.</p> <p>Sensitivity analysis performed for the parameters in the model (Government of South Australia 2010).</p>
<p>Citizen science (Sections 7.1 and 7.7)</p>	<p>In complex data collection methods, variability of data collected by volunteers as non-professionals can be greater compared to professionally collected data (Aceves-Bueno et al., 2017). However, citizen science can offer broader collection of data, analysis of the data accuracy is required in citizen science projects.</p>	<p>Sensor accuracy is too low.</p> <p>Too complex data collection methods for unexperienced users.</p> <p>Instructions are misunderstood.</p> <p>Challenges with validating the data quality (Pocock et al., 2014)</p>	<p>Clear protocols, frameworks, and instruments including those for transparent communication (e.g., Dickinson and Bonney, 2012; Dickinson, Zuckerberg, and Bonter, 2010).</p> <p>Proper training of the volunteers (e.g., Dickinson and Bonney, 2012).</p> <p>Adopt more advanced statistical analyses to identify errors (Dickinson, Zuckerberg, and Bonter, 2010; Pocock et al., 2014).</p> <p>Collection of a greater number of samples to eliminate sampling bias (e.g., Gardiner et al., 2012)</p>

7.10.1 Data gaps and irregularities

In many cases, data gaps exist in monitoring efforts. Data gaps can be spatial or temporal. Also, low quality of the data can be considered as insufficient data collection. Data gaps can exist in all types of monitoring, including manual or automated measurements, surveys and questionnaires. Often, when the monitoring plan is built, the main aspects to be considered are the frequency of monitoring and distribution as well as the amount of monitoring sites. This is because data gaps are mainly caused by data provision interruption or insufficient observation coverage (both sampling frequency and spatial distribution). This data gaps may lead to data insufficiency which can disqualify the dataset from the holistic NBS performance assessment. Insufficient data collection may also originate from the lack of resources. In the interpretation of the monitoring results, it is critical to identify the data gaps. There are existing techniques to fill the data gaps e. g. spatial/temporal interpolation, but a special attention should be paid in order not to degrade the representatives of the data. Table 7-16 lists the data gaps identified by some of EU-H2020 projects on NBS.

Table 7-16. Data gaps identified in EU-H2020 projects (selected examples).

Project	Identified data gaps
ConnectingNature	Indicator data are foreseen to cover less than 50% of the Connecting Nature core indicator list. Therefore, there is a requirement for further rounds of identification of suitable data sources to be undertaken, and there may also be a need for new observations and site surveys to be undertaken to fill in any gaps.
proGIreg	Gaps in statistical data due to: <ul style="list-style-type: none"> • No cities have been able to provide all the requested data • Depending on the city, some data are not available on a yearly base
OPERANDUM	<ul style="list-style-type: none"> • Lack of hydro-meteorological observations time series/low station density which was partially resolved using remodelled ERA40 data set • Gaps in in-situ meteorological observations
Inala	<ul style="list-style-type: none"> • Some cities are not able to expose NBS monitoring data • Baseline data for some of the NBS are missing • During the monitoring period, there is a risk of gaps and time-series inhomogeneity (e.g., precipitation, air quality)
Urbina	The project involves and compares several European cities in order to develop sustainable health corridors. However, the availability of socioeconomic official data differs from city to city

As an example of how to analyse existing data gaps in monitoring, the California Department of Water Resources (2016) presents a data gap analysis flow chart for groundwater monitoring. First question when planning a data collection

procedure is to consider the needed types of data, for instance water level and water quality. It should be then considered if the quantity and quality of the data are sufficient. After this, data gaps are identified. As mentioned, the data gaps can be spatial, temporal, or they can be related to low data quality. Temporal data gaps are related to insufficient frequency of the monitoring, and spatial data gaps to insufficient number of monitoring sites. As an example of low quality data, it can originate from insufficient collection or data management methods. After identification of the data gaps, causes for the existence of the gaps should be identified. The causes can be related to insufficient funding and resources but also to insufficient access to the data. Actions to reduce the amount of data gaps are to increase density, frequency, and quality of the monitoring.

7.10.2 Data granularity and resolution

Data granularity is one of the most critical parameters for successful evaluation of NBS performance and impacts, because it allows to define an effective and efficient solution, or (if not well dimensioned) can impede the achievement of the goals of a project. Data granularity indicates the level of detail expressed by each single part in a dataset. Different granularities indicate different levels of aggregation in the dataset. Examples of aggregation include:

- Temporal aggregations: year, month, minute, second
- Distance aggregations: kilometres (km), hectometres (hm), decametres (dam), metres (m), decimetres (dm), centimetres (cm), millimetres (mm)
- Geographic (or zonal) aggregations: world, continent, country, city, district, street, address
- Video aggregations: HD, FULL HD, 4K, 8K

Fine-granularity (low level of aggregation) provides more details than **coarse-granularity** (high level of aggregation) making it more helpful for decision-making. In fact, the higher amount of information ensured by fine-granularity permits to better target the problem to be solved (i.e., climate change, social issue, service inefficiency), by making the correlation between causes and effects more comprehensive.

Since a variety of data types (collected with a likewise variety of monitoring methods) are required to obtain a full NBS assessment in all its dimensions (ecological, social, etc.), it is imperative that the granularity of all the different datasets matches the scale of main driving processes behind the NBS and the impact of NBS interventions. A reliable evaluation cannot otherwise be obtained. As an example, in the EU-H2020 project proGIreg problems in data granularity were encountered due to the different scales at which statistical data are available in the different countries, and due to the small size of most of the implemented NBS with respect to the scale available for statistical data.

Unfortunately, a general formula for defining the granularity level does not exist. Thus, technical designers can leverage only on their good experience to set the correct aggregation in the range of fine-grain and large-grain, considering the variability of the monitored phenomenon and the level of detail needed for the evaluation and eventually the use of proxy variables to improve the granularity of the main variable. Table 7-17 shows the possible levels of data granularity required to evaluate the impact of an NBS for some specific examples.

Table 7-17. Examples of adequate vs inadequate data granularity levels.

Topic	Goal of the Study	Adequate/Possible Data Granularity	Inadequate/Wrong Data Granularity
Urban Heat	Assess <u>daily</u> fluctuations of the urban temperature	<ul style="list-style-type: none"> • Fine grain: 30 minutes • Medium grain: 60 minutes • Coarse grain: 180 minutes 	<ul style="list-style-type: none"> • Over sampled: second, millisecond • Lower sampled: at day scale no changes can be observed
Flooding	Assess flooding events per <u>year</u>	<ul style="list-style-type: none"> • Fine grain: day • Medium grain: 5 days • Coarse grain: 30 days 	<ul style="list-style-type: none"> • Over sampled: minute, second, millisecond • Lower sampled: at year scale no changes can be observed
Urban Green Areas	Estimate green density in the urban area	<ul style="list-style-type: none"> • Fine grain: 10 sq.m (*) • Medium grain: 200 sq.m • Coarse grain: 1 sq. Km 	<ul style="list-style-type: none"> • Over sampled: sq.cm, sq. mm (*) • Lower sampled: 30 sq.Km
Urban Transportation	Assess <u>yearly</u> fluctuations of users of urban transportation	<ul style="list-style-type: none"> • Fine grain: number of passengers at 30 minutes (for each line) • Medium grain: number of passengers per day (for each line) • Coarse grain: number of passengers per month (total) 	<ul style="list-style-type: none"> • Over sampled: number of passengers per second (for each line) • Lower sampled: number of passengers per year (total)

(*) sq. stands for square. For example, sq.m stands for square metre.

When talking about a representation (e.g., video streaming, image, photo, spatial data), granularity takes the name of **resolution** and indicates the size of the minimum unit/area in a representation (e.g., video streaming, image, photo, spatial data). Spatial resolution is a common and essential feature in monitoring systems and indicates the ability of the sensor to detect details of the complex environments, and the minimum area is measured in meters.

Low spatial resolution sensors (30–300 m) produce adequate results at large scales, although they are incapable of capturing greater amount of details as high spatial resolution outputs (less than 30 m). High resolution is essential for characterisation and interpretation of complex environments and models. As example, in urban flood and hydraulic studies of river and floodplain interactions, topographic details significantly influence the capability to discover the flow path interactions with the underlying terrain (Krebs et al., 2014; Mason et al., 2007).

In conclusion, to assess the impact of a NBS or the development and distribution of a phenomenon in the ecosystem, it is critical to define the correct level of aggregation, the data granularity, of the measurements for both the time (temporal granularity) and the location (spatial resolution). In that respect, fine-grain and high-resolution local monitoring sensors (or their combination) often represent the most suitable option to record the actual changes in the urban system fostered by the implemented NBS.

7.10.3 Data Accuracy

The **accuracy** is the qualitative parameter indicating the degree of correctness of a measure derived from the direct observation (sample) with respect to the objective true or the reference value. In other words, the accuracy quantifies how much a measure is near the actual value. The common way to express the accuracy is the percentage, calculated with respect to the full scale of the sensor, or with respect to the sample. As example, a temperature sensor with full scale of $\pm 50^\circ$ and accuracy of $\pm 1\%$ ($\pm 0.05^\circ$), means that with an actual value of 30° the sensor could produce a measure in the range between 29.95° and 30.05° (Figure 7-6).

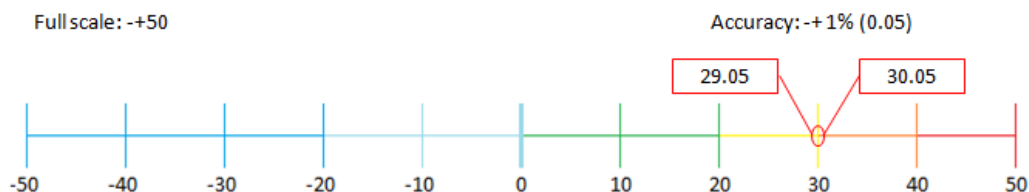

Figure 7-8. Temperature sensor with full scale of $\pm 50^\circ$ and accuracy of $\pm 1\%$ ($\pm 0.05^\circ$): The sensor can produce a measure in the range between 29.95° and 30.05° , if the actual value to be measured is 30° .

Another relevant qualitative parameter in the context of monitoring activities is the **precision** that indicates the degree of convergence (or dispersion) in a collection of samples. In other words, precision indicates how much independent samples are near among them. The precision is strictly dependent from the effectiveness of the combination of sensors adopted and methodologies implemented during the observations. In fact, despite each sensor expresses static qualitative performance, the combination of sensors with different methodologies could produce different precision and vice versa.

To better clarify the relationship between precision and accuracy, Figure 7-7(a) represents the results obtained with a good quality temperature sensor. That sensor has high precision and high accuracy and for each observation collects measures aggregated near the actual value. Figure 7-7(b) represents the results obtained with a temperature sensor with high precision and low accuracy that for each observation collects aggregated measures, but far from the actual value. Figure 7-7(c) represents the results obtained with a low quality temperature sensor with low precision and low accuracy that for each observation collects measures dispersed and far from the actual value.

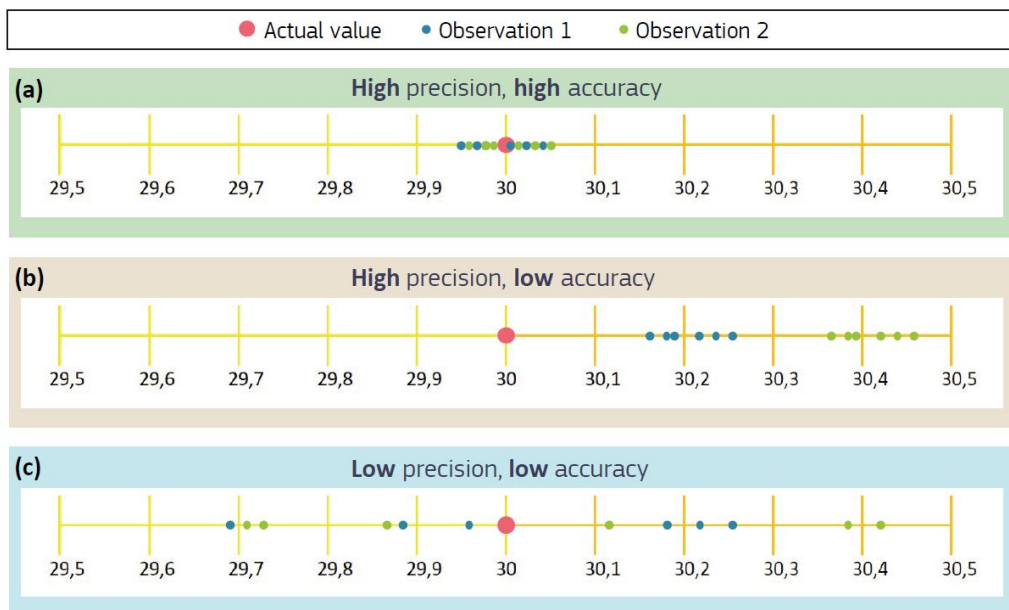

Figure 7-9. Measurements obtained with a temperature sensor which has (a) high precision and high accuracy (good quality sensor); (b) high precision bur low accuracy; (c) low precision and low accuracy (low quality sensor). The red dot represents the actual ("true") value of temperate. The blue and green dots represent the first sample collection (Observation 1) and second sample collection (Observation 2) respectively.

Accuracy and precision are critical qualitative parameters to be taken into account during the monitoring activities. In fact, they indicate the quality of data and, as a consequence, are decisive to approve or reject the models and related

elaborations that are the base line for supporting the performance monitoring, impact assessment and more in general the decision making.

7.10.4 Biases, main error sources, and data reliability

Aggregation and resolution provide useful information about the dimension of the measures. However, the observations can be influenced by uncontrollable and predictable factors that can introduce accidental and systematic errors that could invalidate the sampled measurements.

Accidental errors are caused by unpredictable conditions (as lack of energy or connection, vibrations near an instrument, wind) that randomly influence the results and for this reason they cannot be avoided.

A **bias** is a systematic error that introduces a constant or proportional deviation (absolute or percentage) with respect to the actual value. Biases can be generated by different unfavourable conditions:

- Instrumental: inadequate, out of scale, or not well calibrated sensors;
- Methodology: approximated models, incorrect formulas and elaborations, inadequate experimental conditions (e.g., temperature, humidity, not appropriate insolation);
- Personal: lack of expertise in the operator, parallaxes, interferences, improper use of the sensors or the methodology.

Despite the accidental and systemic errors cannot be eliminated, a good and complete monitoring plan will permit to prevent and identify potential conditions that could generate errors. Identified errors can be solved or minimised with the application of the corrective actions, such as identification of the incorrect samples, definition of more precise methodologies, procedures and rules.

Error sources:

- Not identified and corrected systematic error;
- Lack of attention, or overload of work;
- Overlaps applying heterogeneous methodologies or procedures.

7.10.5 Data Accessibility

Quantitative and qualitative data generated throughout the NBS monitoring periods via remote and in-situ observations, questionnaires, surveys or other means may have different access rights (e.g., open, semi-open, or confidential)

depending on the degree of confidentiality originally specified in the legal or data management plans. It may be openly available or subjected to access restrictions imposed by governing bodies or EU-level regulations, such as General Data Protection Regulation (GDPR) (EC, 2016). The latter concerns the personal data collection during, for example, Urban Living Lab (ULL) sessions, health and well-being surveys or other studies involving humans. Naturally, not all data generated can be made public, so any personally identifiable information, which can be potentially generated during the project, should be carefully considered before and throughout NBS implementation to avoid disclosing any sensitive information. Here, it should be noted that availability and accessibility mean “existence” and “possibility and ease of retrieval”, respectively. While accessible data is concomitantly available, “availability” does not imply “accessibility”.

Although municipalities or other data owners may be reluctant to make their data open access and share this data with the third parties, open data has numerous benefits over restricted access data. Often, numerous datasets do not bring any additional value because of their inaccessibility to the third parties. Open data can be widely utilised by research institutes and universities by applying it in research and education to generate, for instance, projections and scenarios based on the historical records. The possibility to use open datasets for producing

“The amount of data generated throughout the duration of the NBS implementation process is vast. Data storage, management, ownership and access are among the critical factors that must be considered. Adoption of a data management plan is a transparent way to ensure data quality, data standards and data reusability.”
(Hawxwell et al. 2018)

various simulations and utilising them for NBS baseline conditions assessment brings an added value to the datasets and their owners.

Data accessibility plays a critical role in establishing a holistic NBS evaluation framework as it is essential for establishing pre-NBS baseline conditions. When only fragmented or irregular datasets are accessible, it creates considerable bias and the possible need for data aggregation or other

modifications of data points leading to biased outputs. In that respect, caution should be exercised when, for example, EU-wide datasets available from external sources are integrated in the NBS monitoring framework.

Despite the restricted access to some of the datasets being generated during the NBS projects, many data and results are accessible through the platforms established by the projects. This is of outmost importance as data-informed decision- and policymaking are critical for a wider NBS implementation in urban areas. Not only open data provides such attributes to urban development, it encourages greater collaboration in NBS implementation through ample evidence of benefits and issues recorded and obtained via open data sources.

7.10.6 Metadata and data standardization

The increasing effort in providing science-based evidence of NBS effectiveness and (co-)benefits has resulted into increasing volumes of data required for and/or connected to the monitoring and assessment of NBS interventions. These data are often associated with single-case studies and disseminated to a small community (usually the group of main investigators involved in a given NBS project), but no established protocols are yet in place that guarantee their accessibility and long-term re-usability by the large community. This clearly undermines our ability to achieve statistically meaningful evidence and more generalizable results on NBS performances and impacts, besides impeding the possibility to take full advantage of data which already exist but are either not accessible or easy to understand.

It therefore of crucial importance that NBS-related data become aligned to FAIR data principles, following the example of other disciplines and research fields. FAIR is an acronym which stands for Findability, Accessibility, Interoperability, and Reusability of data (Wilkinson et al., 2016). These four principles have been endorsed by the EC (Hodson et al., 2018) and many other institutions worldwide as those that should guide the design and implementation of any good data management, in order to ensure and maximize digital data discoverability and exchange. In practice, this means that NBS data producers and publishers should make an effort in following the guidelines (FAIR principles) summarized in Figure 7-8a or, in simpler words, that NBS data should be supplemented by contextual documentation, provided with persistent identifiers and metadata, and common standards adopted for both data and metadata (Figure 7-8b). In this perspective, metadata are an essential aspect of data standardization.

Metadata, or data about data, enrich dataset with additional information such as basic characteristics of the datasets (e.g., measured phenomena, author, and spatial/temporal resolution), quality, and completeness. This allows users or computers to better assess datasets for a specific use. Metadata enable easier data discovery since it exposes information about the data which would normally be hidden within the dataset itself. This allows inspecting information such as quality, resolution or spatial/temporal coverage without opening/inspecting the dataset and allows seamless integration of data from different sources. Several International standards exist which facilitate an easier adoption of FAIR principles.

The FAIR Guiding Principles

To be Findable:

- F1. (meta)data are assigned a globally unique and persistent identifier
- F2. data are described with rich metadata (defined by R1 below)
- F3. metadata clearly and explicitly include the identifier of the data it describes
- F4. (meta)data are registered or indexed in a searchable resource

To be Accessible:

- A1. (meta)data are retrievable by their identifier using a standardized communications protocol
 - A1.1 the protocol is open, free, and universally implementable
 - A1.2 the protocol allows for an authentication and authorization procedure, where necessary
- A2. metadata are accessible, even when the data are no longer available

To be Interoperable:

- I1. (meta)data use a formal, accessible, shared, and broadly applicable language for knowledge representation.
- I2. (meta)data use vocabularies that follow FAIR principles
- I3. (meta)data include qualified references to other (meta)data

To be Reusable:

- R1. meta(data) are richly described with a plurality of accurate and relevant attributes
 - R1.1. (meta)data are released with a clear and accessible data usage license
 - R1.2. (meta)data are associated with detailed provenance
 - R1.3. (meta)data meet domain-relevant community standards

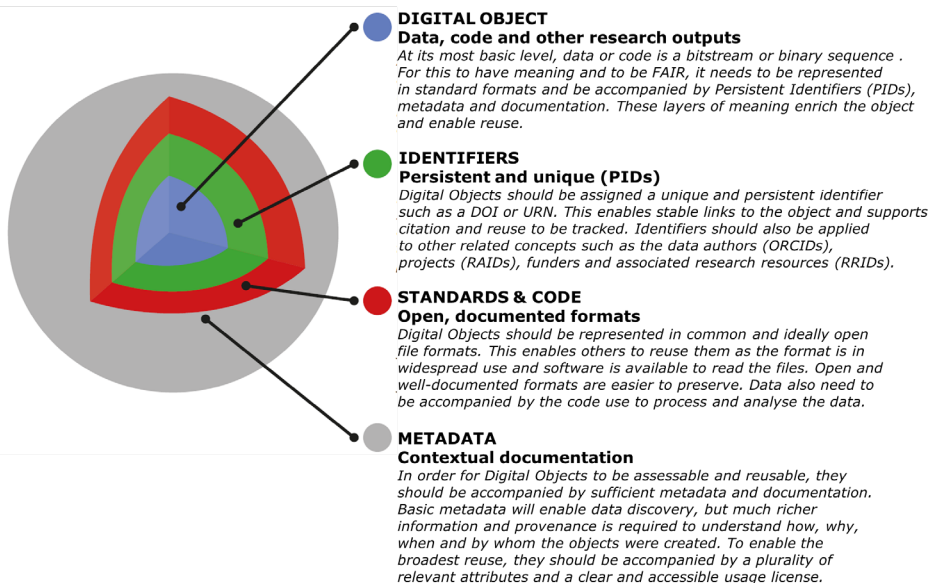

Figure 7-10. (Top) The set of Fair Principles (source: Wilkinson et al., 2016). (Bottom) a simplified schema explaining the key elements needed to ensure FAIR data (source: Hodson et al., 2018).

Table 7-18 lists some of the most relevant standards in the domain of geospatial data, metadata and services. Another example of standard is the EU Directive INSPIRE (<https://inspire.ec.europa.eu/>), which aims to create a European Union spatial data infrastructure where environmental data collected on a national basis can be shared and used on a pan-European basis. In recent years, the importance of data standardization has become clear also in the context of NBS and some NBS projects have made significant efforts in developing successful data management plans. For example, the EU-H2020 project OPERANDUM has developed a NBS data portal which is fully compatible with semantic web and is OGC and INSPIRE compliant. Data newly generated by the project (along with data gathered from external sources semi-automatically) are complemented with metadata and harmonized according to ISO standards, thus fulfilling the FAIR principles. For more information on FAIR recommendations and guidelines, the reader can refer to the EC report by Hodson et al. (2018). For examples of international standards applied in the context of NBS projects, see Vranic et al. (2019).

7.11 Conclusion

Successful evaluation of NBS performance and impact rely on the selection of the appropriate data collection methods, and the quality of data and its inherent characteristics (e.g., granularity and homogeneity) generated throughout the NBS monitoring period. This Chapter covered a variety of data types and data acquisition and generation techniques and discussed their benefits and limitations applicable to NBS impact evaluation.

Information for NBS impact evaluation, including a crucial step of baseline assessment, can be obtained via multiple sources, including in-situ measurements, laboratory experiments, remote sensing or Earth observation techniques, and citizen science. The selection of data collection methods should be based on solid planning, technical expertise, and a wide knowledge of the state of the environment and its functioning to ensure that the relevant and accurate data are collected for the purposeful NBS monitoring and assessment. Current and projected NBS impact can be further evaluated by modelling. All data produced during the NBS monitoring activities must undergo careful evaluation for possible biases and main error sources to ensure its adequacy and reliability.

Data collection and generation methods for NBS impact assessment discussed herein can be supplemented with a multitude of datasets obtained from the inter-European and international databases, although special care should be taken regarding their spatial and temporal resolution. Collected and generated data from a variety of sources can be integrated to provide valuable insights on the impacts and co-benefits of a NBS intervention in comparison to a baseline scenario.

Examples from the NBS projects regarding, for instance, non-spatial and spatial data integration, data gaps and modelling approaches to complement data generation were highlighted throughout the Chapter.

Table 7-18. Relevant International data standards following ISO, OGC, etc.

Category	International Standards	Description
Observations	ISO 19156 (Observations and Measurements)	A conceptual schema for observations, and for features involved in sampling when making observations. It provides models for the exchange of information describing observation acts and their results, both within and between different scientific and technical communities.
	SensorML (OGC Sensor Model Language)	It provides a robust and semantically-tied means of defining processes and processing components associated with the measurement and post-measurement transformation of observations.
	SOS (OGC Sensor Observation Service)	It defines a web service interface which allows querying observations, sensor metadata, as well as representations of observed features. Also, this standard defines means to register new sensors and to remove existing ones
	SPS (OGC Sensor Planning Service)	It defines interfaces for queries that provide information about the capabilities of a sensor and how to task the sensor.
	STA (OGC SensorThings API)	It provides an open, geospatial-enabled and unified way to interconnect the Internet of Things (IoT) devices, data, and applications over the Web.
Geospatial Data	ISO 19107 (Spatial schema)	Conceptual schemas for describing the spatial characteristics of geographic features, and a set of spatial operations consistent with these schemas.
	ISO 19125 (Simple feature access)	A simplified model of ISO 19107 which consists of two parts: 1) a common architecture for geographic information, and 2) a specific Structured Query Language (SQL) schema that supports storage, retrieval, query and update of simple geospatial feature collections.
	ISO 19136 (Geography Markup Language)	An XML encoding in accordance with ISO 19118 for the transport and storage of geographic information modelled in accordance with the conceptual modelling framework used in the ISO 19100 series of International Standards and including both the spatial and non-spatial properties of geographic features.

	ISO 19129 (Imagery, gridded and coverage data framework)	Framework for imagery, gridded and coverage data. This framework defines a content model for the content type imagery and for other specific content types that can be represented as coverage data.
Metadata	ISO 19115 (Metadata)	It defines the schema required for describing geographic information and services by means of metadata. It provides information about the identification, the extent, the quality, the spatial and temporal aspects, the content, the spatial reference, the portrayal, distribution, and other properties of digital geographic data and services.
	ISO 19139 (Metadata XML schema implementation)	It defines XML based encoding rules for conceptual schemas specifying types that describe geographic resources. The encoding rules support the UML profile as used in the UML models commonly used in the standards developed by ISO/TC 211. The encoding rules use XML schema for the output data structure schema
Services	ISO 19119 (Services)	Platform requirements on how services shall be created, in order to allow for one service to be specified independently of one or more underlying distributed computing platforms.
	ISO 19128 (Web Map Server)	Specifications on the behaviour of a service that produces spatially referenced maps dynamically from geographic information.
	ISO 19142 (Web Feature Service (WFS))	Specifications on the behaviour of a web feature service providing transactions on/access to geographic features in a manner independent of the underlying data store. It specifies discovery operations, query operations, locking operations, transaction operations and operations to manage stored parameterized query expressions.
	OGC WCS (OGC Web Coverage Service)	Specifies the behaviour of a service that serves multi-dimensional coverage data. WCS Core specifies a core set of requirements that a WCS implementation must fulfil.
	OGC CAT (Catalogue Service)	Catalogue services support the ability to publish and search collections of descriptive information (metadata) for data, services, and related information objects. Metadata in catalogues represent resource characteristics that can be queried and presented for evaluation and further processing by both humans and software.

Common Conceptual Model	ISO 19103 (Conceptual schema language)	Rules and guidelines for the use of a conceptual schema language within the context of geographic information. The chosen conceptual schema language is the Unified Modelling Language (UML).
	ISO 19109 (Rules for application schema)	Rules for creating and documenting application schemas, including principles for the definition of features.
	ISO 19118 (Encoding)	Requirements for defining encoding rules for use for the interchange of data that conform to the geographic information in the set of International Standards known as the "ISO 19100 series".

7.12 References

- Aceves-Bueno, E., Adeleye, A.S., Feraud, M., Huang, Y., Tao, M., Yang, Y. and Anderson, S.E., 'The Accuracy of Citizen Science Data: A Quantitative Review', *Bulletin of the Ecological Society of America*, Vol. 98, No 4, 2017, pp. 278-290. <https://doi.org/10.1002/bes2.1336>
- Arnold, J.G., Kiniry, J.R., Srinivasan, R., Williams, J.R., Haney, E.B., and Neitsch, S.L., *Soil and Water Assessment Tool: Input/Output Documentation*, Texas Water Resources Institute, 2012.
- Bagheri Z., Nadoushan, M.A., and Abari, M.F., 'Evaluation the effect of green space on air pollution dispersion using satellite images and landscape metrics: A case study of Isfahan City', *Fresenius Environmental Bulletin*, Vol. 25, No 12, 2017, pp. 8135-8145.
- Baldacchini, C., *Monitoring and Assessment Plan*, Deliverable No. 4.1, proGireg. Horizon 2020 Grant Agreement No 776528, European Commission, 2019, pp. 124. https://progireg.eu/fileadmin/user_upload/Deliverables/V2_D4.1_proGireg_CNR_2020-06-13_amendment_02_.pdf.
- Bamberger, P., 'Reconstructing Baseline Data for Impact Evaluation and Results Measurement', *PREM notes*, No 4, The World Bank, 2010. <http://hdl.handle.net/10986/11075>
- Bamberger, P., Rugh, J. and Mabry, L., *Realworld Evaluation: Working Under Budget, Time, Data, And Political Constraints*, Sage Publications, Thousand Oaks, 2006.
- Baró, F., Chaparro, L., Gómez-Baggethun, E., Langemeyer, J., Nowak, D.J., Terradas, J., 'Contribution of ecosystem services to air quality and climate change mitigation policies: The case of urban forests in Barcelona, Spain', *Ambio*, Vol. 43, 2014, pp. 466-479.
- Barton, H., and Grant, M., 'A health map for the local human habitat', *Journal of the Royal Society for the Promotion of Health*, Vol. 126, 2006, pp. 252-253. doi: 10.1177/1466424006070466
- Bass, B., Krayenhoff, S., Martilli, A., and Stull, R., *Mitigating the urban heat island with green roof infrastructure*, Urban Heat Island Summit, Toronto, 2002.
- Bealey, W.J., McDonald, A.G., Nemitz, E., Donovan, R., Dragosits, U., Duffy, T.R., and Fowler, D., 2007. 'Estimating the reduction of urban PM10 concentrations by trees within an environmental information system for planners', *Journal of Environmental Management*, Vol. 85, 2007, pp. 44-58.
- Beyer, K.M., Kaltenbach, A., Szabo, A., Bogar, S., Nieto, F.J. and Maleczi, K.M., 'Exposure to neighborhood green space and mental health: evidence from the survey of the health of Wisconsin', *International Journal of Environmental Research and Public Health*, Vol. 11, 2014, pp. 3453-3472.
- Bojinski, S., Verstraete, M., Peterson, T. C., Richter, C., Simmons, A., and Zemp, M., 'The concept of essential climate variables in support of climate research, applications, and policy', *Bulletin of the American Meteorological Society*, Vol. 95, No 9, 2014, pp. 1431-1443.
- Bonelli, S., 'The first red list of Italian butterflies', *Insect Conservation and Diversity*, Vol. 11, 2018, pp. 506-5821.
- Brown, I. and Castellazzi, M., 'Scenario analysis for regional decision making on sustainable multifunctional land uses', *Regional Environmental Change*, Vol. 14, 2014, p. 15.
- Brunetti, G., Šimůnek, J., and Piro, P., 'A comprehensive numerical analysis of the hydraulic behavior of a permeable pavement', *Journal of Hydrology*, Vol. 540, 2016, pp. 1146-1161. <https://doi.org/10.1016/j.jhydrol.2016.07.030>
- Brunetti, G., Šimůnek, J., Turco, M., and Piro, P., 'On the use of surrogate-based modeling for the numerical analysis of low impact development techniques', *Journal of Hydrology*, Vol. 548, 2017, pp. 263-277. <https://doi.org/10.1016/j.jhydrol.2017.03.013>
- Bruse, M., *ENVI-Met Implementation of the Gas/Particle Dispersion and Deposition Model PDDM*, 2017. Available online: <http://www.envi-met.net/documents/sources.PDF>
- California Department of Water Resources, *Monitoring Networks and Identification of Data Gaps BMP*, 2016, pp. 1-34.
- Chen, H., Ooka, R., Huang, H., and Tsuchiya, T., 'Study on mitigation measures for outdoor thermal environment on present urban blocks in Tokyo using coupled simulation', *Building and Environment*, Vol. 44, No 11, 2009, pp. 2290-2299.
- Ciais, P., Dolman, A.J., Bombelli, A., Duren, R., Pregon, A., Rayner, P.J., Miller, C., Gobron, N., Kinderman, G., Marland, G., Gruber, N., Chevallier, F., Andres, R.J., Balsamo, G., Bopp, L., Bréon, F.-M., Broquet, G., Dargaville, R., Battin, T.J., Borges, A., Bovensmann, J.H., Buchwitz, M., Butler, J., Canadell, J.G., Cook, R.B., DeFries, R., Engelen, R., Gurney, K.R., Heinze, C., Heimann, M., Held, A., Henry, M., Law, B.,

- Luyssaert, S., Miller, J., Moriyama, T., Moulin, C., Myneni, R.B., Nussli, C., Obersteiner, M., Ojima, D., Pan, Y., Paris, J.-D., Piao, S.L., Poulter, B., Plummer, S., Quegan, S., Raymond, P., Reichstein, M., Rivier, L., Sabine, C., Schimel, D., Tarasova, O., Valentini, R., Wang, R., van der Werf, G., Wickland, D., Williams, M., and Zehner, C., 'Current systematic carbon-cycle observations and the need for implementing a policy-relevant carbon observing system', *Biogeosciences*, Vol. 11, 2014, pp. 3547–3602. doi: 10.5194/bg-11-3547-2014
- Clobert, J., Chanzy, A., Le Galliard, J.-F., Chabbi, A., Greiveldinger, L., Caquet, T., Loreau, M., Mouglin, C., Pichot, C., Roy, J. and Saint-André, L., 'How to Integrate Experimental Research Approaches in Ecological and Environmental Studies: AnaEE France as an Example', *Frontiers in Ecology and Evolution*, Vol. 6, 2018, p. 43. doi: 10.3389/fevo.2018.00043
- Cohen, D.A., Setodji, C., Evenson, K.R., Ward, P., Lapham, S., Hillier, A., and McKenzie, T.L., 'How much observation is enough? Refining the administration of SOPARC', *Journal of Physical Activity and Health*, Vol. 8, No 8, 2011, pp. 1117-1123.
- Corbane, C., Martino, P., Panagiotis, P., Aneta, F.J., Michele, M., Sergio, F., Marcello, S., Daniele, E., Gustavo, N., and Thomas, K., 'The grey-green divide: multi-temporal analysis of greenness across 10,000 urban centres derived from the Global Human Settlement Layer (GHSL)', *International Journal of Digital Earth*, Vol. 13, No 1, 2020, pp. 101-118.
- Creswell, J.W., 'Mixed-method research: Introduction and application', In: G.J. Cizek (Ed.) *Handbook of educational policy* (pp. 455-472), Academic Press, 1999.
- Csillag, F. and Boots., B., 'A Framework for Statistical Infer-ential Decisions in Spatial Pattern Analysis', *Canadian Geographer*, Vol. 49, No 2, 2005, pp. 172–179.
- Dickinson, J.L. and Bonney, J.R.E. (Eds.), *Citizen science: Public participation in environmental research*, Cornell University Press, 2012.
- Dickinson, J.L., Zuckerberg, B., and Bonter, D.N., 'Citizen science as an ecological research tool: challenges and benefits', *Annual review of ecology, evolution, and systematics*, Vol. 41, 2010, pp. 149-172.
- Dushkova, D. and Ignatieva, M., 'New trends in urban environmental health research: from geography of diseases to therapeutic landscapes and healing gardens', *Geography, Environment, Sustainability*, Vol. 13, No 1, 2020, pp. 159-171. <https://doi.org/10.24057/2071-9388-2019-99>
- Dushkova, D. and Dagmar, H., 'Not Simply Green: Nature-Based Solutions as a Concept and Practical Approach for Sustainability Studies and Planning Agendas in Cities', *Land*, Vol. 9, 2020, p. 19. 10.3390/land9010019.
- European Space Agency (ESA), *Newcomers Earth Observation Guide*, 2019. Available at: <https://business.esa.int/newcomers-earth-observation-guide>.
- European Parliament and of the Council of the European Union, 'Directive 2007/2/EC of the European Parliament and of the Council of 14 March 2007 establishing an Infrastructure for Spatial Information in the European Community (INSPIRE)', *Official Journal of the European Union* L 108, 2007, p. 1–14.
- European Parliament and of the Council of the European Union, 'Regulation (EU) 2016/679 of the European Parliament and of the Council of 27 April 2016 on the protection of natural persons with regard to the processing of personal data and on the free movement of such data, and repealing Directive 95/46/EC', *Official Journal of the European Union* L 119, 2016, pp. 1-88.
- Statistical Office of the European Union (Eurostat), *Glossary*, 2014. https://ec.europa.eu/eurostat/statistics-explained/index.php/Glossary:Baseline_study
- Statistical Office of the European Union (Eurostat), Statistical regions in the European Union and partner countries: NUTS and statistical regions 2021, *Publications Office of the European Union*, Luxembourg, 2020. <https://ec.europa.eu/eurostat/documents/3859598/10967554/KS-GQ-20-092-EN-N.pdf/9d57ae79-3ee7-3c14-da3e-34726da385cf>
- Frantzeskaki, N., McPhearson, T., Collier, M. J., Kendal, D., Bulkeley, H., Dumitru, A., Walsh, C., Noble, K., van Wyk, E., Ordóñez, C., Oke, C., and Pintér, L., 'Nature-based solutions for urban climate change adaptation: linking science, policy, and practice communities for evidence-based decision-making', *BioScience*, Vol. 69, No 6, 2019, pp. 455-466.
- Frumkin, H., Bratman, G.N., Breslow, S.J., Cochran, B., Kahn Jr., P.H., Lawler, J.J., Levin, P.S., Tandon, P.S., Varanasi, U., Wolf, K.L. and Wood, S.A., 'Nature contact and human health: A research agenda', *Environmental health perspectives*, Vol. 125, No 7, 2017, p. 075001.
- Gardiner, M.M., Allee, L.L., Brown, P.M., Losey, J.E., Roy, H.E., and Smyth, R.R., 'Lessons from lady beetles: accuracy of monitoring data from US and UK citizen-science programs', *Frontiers in Ecology and the Environment*, Vol. 10, No 9, 2012, pp. 471-476.

- Gittleman, M., Farmer, C.J., Kremer, P., and McPhearson, T., 'Estimating stormwater runoff for community gardens in New York City', *Urban ecosystems*, Vol. 20, No 1, 2017, pp. 129-139.
- Government of South Australia, 'Chapter 15: Modelling Process and tools', *Water Sensitive Urban Design Technical Manual for the Greater Adelaide Region*, Government of South Australia, Adelaide, 2010, p. 48.
- Grizzetti, B., Bouraoui, F. and Aloe, A., 'Changes of nitrogen and phosphorus loads to European seas', *Global Change Biology*, Vol. 18, 2012, pp. 769-782.
- Groenewegen, P.P., van den Berg, A.E., de Vries, S. and Verheij, R.A., 'Vitamin G: effects of green space on health, well-being, and social safety', *BMC Public Health*, Vol. 6, 2006, p. 149.
- Gruiz, K., Meggyes, T., and Fenyvesi, E., *Engineering Tools for Environmental Risk Management: 3. Site Assessment and Monitoring Tools*, CRC Press, 2017.
- Grützner, R., 'Environmental modeling and simulation - applications and future requirements', *Environmental Software Systems*, Springer Science+Business Media, Dordrecht, 1996.
- Guida, R.J., Swanson, T.L., Remo, J.W., and Kiss, T., 'Strategic floodplain reconnection for the Lower Tisza River, Hungary: opportunities for flood-height reduction and floodplain-wetland reconnection', *Journal of Hydrology*, Vol. 521, 2015, pp. 274-285.
- Guo, B., Wang, Z., Yu, Z., Wang, Y., Yen, N., Huang, R., and Zhou, X., 'Mobile Crowd Sensing and Computing: The Review of an Emerging Human-Powered Sensing Paradigm', *ACM Computing Surveys*, Vol. 48, 2015.
- Haase D., Haase A., Kabisch N., Kabischb S., and Rink D., 'Actors and factors in land-use simulation: The challenge of urban shrinkage', *Environmental Modelling and Software*, Vol. 35, 2012, pp. 92-103.
- Hamad R., Balzter H., and Kolo K., 'Predicting land use/land cover changes using a CA-Markov model under two different scenarios', *Sustainable*, Vol. 10, 2018, p. 3421.
- Hampton, S.E., Strasser, C.A., Tewksbury, J.J., Gram, W.K., Budden, A.E., Batcheller, A.L., Duke, C.S., and Porter, J.H., 'Big data and the future of ecology', *Frontiers in Ecology and the Environment*, Vol. 11, No 3, 2013, pp. 156-162.
- Hansen, R., Rolf, W., Santos, A., Luz, A.C., Száraz, L., Tosics, I., Vierikko, K., Rall, E., Davies, C., and Pauleit, S., *Advanced Urban Green Infrastructure Planning and Implementation - Innovative Approaches and Strategies from European Cities*, Deliverable 5.2. Technical Report of the Green Surge Project, 2016.
- Hartig T., Mitchell R., de Vries S., and Frumkin H., 'Nature and health', *Annual Review of Public Health*, Vol. 35, 2014, pp. 207-228.
- Hecker, S., Haklay, M., Bowser, A., Makuch, Z., Vogel, J., and Bonn, A., *Citizen Science: Innovation in Open Science, Society and Policy*, UCL Press, London, 2018.
- Herold, M., Couclelis, H., and Clarke, K.C., 'The role of spatial metrics in the analysis and modeling of urban land use change', *Computers, environment and urban systems*, Vol. 29, No 4, 2005, pp. 369-399.
- Hirabayashi, S., Kroll, C.N., and Nowak, D.J., 'Development of a distributed air pollutant dry deposition modeling framework', *Environmental Pollution*, Vol. 171, 2012, pp. 9-17.
- Hodson, S., Collins, S., Genova, F., Harrower, N., Jones, S., Laaksonen, L., Mietchen, D., Petrauskaitė, R. and Wittenburg, P., *Turning FAIR into reality: Final report and action plan from the European Commission expert group on FAIR data*, Publications Office of the European Union, Luxembourg, 2018.
- Houghton, J., Townshend, J., Dawson, K., Mason, P., Zillman, J., and Simmons, A., 'The GCOS at 20 years: the origin, achievement and future development of the Global Climate Observing System', *Weather*, Vol. 67, 2012, pp. 227-235.
- Iacob, O., Rowan, J.S., Brown, I.M., and Ellis, C., 'Evaluating wider benefits of natural flood management strategies: An ecosystem-based adaptation perspective', *Hydrology Research*, Vol. 45, No 6, 2014, pp. 774-787.
- Ilieva, R.T. and McPhearson, T., 'Social-media data for urban sustainability', *Nature Sustainability*, Vol. 1, No 10, 2018, pp. 553-565.
- INSPIRE, *INSPIRE Knowledge Base*, 2019. Available from <https://inspire.ec.europa.eu>. Accessed 2019, July 29.
- International Federation of Red Cross and Red Crescent Societies, *Baseline Basics*, 2013.
- International Organization for Standardization (ISO), *ISO 19101-1:2014, Geographic information – Reference model – Part 1: Fundamentals*, International Organization for Standardization, Geneva, 2014.
- International Organization for Standardization (ISO), *ISO/TC 211 Geographic information/Geomatics*, 2019.

- Fernandez, F.J., Alvarez-Velazquez, L.J., Garcia-Chan, N., Martinez, A., and Velazquez-Mendez, M.E., 'Optimal location of green zones in metropolitan areas to control the urban heat island', *Journal of Computational and Applied Mathematics*, Vol. 289, 2015, pp. 412–425.
- Filibeck, G., Petrella, P., and Cornelini, P., 'All ecosystems look messy, but some more so than others: A case-study on the management and acceptance of Mediterranean urban grasslands', *Urban Forestry and Urban Greening*, Vol. 15, 2016, pp. 32–39.
- Florczyk, A.J., Corbane, C., Ehrlich, D., Carneiro Freire, S.M., Kemper, T., Maffenini, L., Melchiorri, M., Pesaresi, M., Politis, P., Schiavina, M., Sabo, F., and Zanchetta, L., *GHSL data package 2019*, Publications Office of the European Union, Luxembourg, 2019.
- Hawxwell, T., Mok, S., Mačiulyte, E., Sautter, J., Theobald, J.A., Dobrokhotova, E., and Suska, P., *Municipal Governance Guidelines*, Urban Nature Labs (UNaLab) Deliverable D6.2, 2018.
- Kabisch, N. and Haase, D., 'Urban nature benefits – Opportunities for improvement of health and well-being in times of global change', *Newsletter on Housing and Health*, Vol. 29, 2018, pp. 1-11.
- Kabisch, N., Stadler, J., Korn H., and Bonn, A., *Nature-based solutions to climate change mitigation and adaptation in urban areas*, Federal Agency for Nature Conservation, Bonn, 2016.
- Kabisch, N., van den Bosch, M., and Laforteza, R., 'The health benefits of nature-based solutions to urbanization challenges for children and the elderly – A systematic review', *Environmental Research*, Vol. 159, 2017, pp. 362-373.
- Kawulich, B., 'Collecting data through observation', *Doing Social Research: A global context*, McGraw-Hill, Berkshire, 2012.
- Krebs, G., Kokkonen, T., Valtanen, M., Setälä, H., and Koivusalo, H., 'Spatial resolution considerations for urban hydrological modelling', *Journal of Hydrology*, Vol. 512, 2014, pp. 482-497.
- Kumar, P., Druckman, A., Gallagher, J., Gatersleben, B., Allison, S., Eisenman, T.S., Hoang, U., Hama, S., Tiwari, A., Sharma, A., Abhijth, K.V., Aslakha, D., McNabola, A., Astell-Burt, T., Feng, X., Skeldon, A.C., de Lusignan, S., and Morawska, L., 'The nexus between air pollution, green infrastructure and human health', *Environment international*, Vol. 133 A, 2019, p. 105181.
- Langevin, C.D., Hughes, J.D., Banta, E.R., Niswonger, R.G., Panday, S., and Provost, A.M., *Documentation for the MODFLOW 6 groundwater flow model (No. 6-A55)*, US Geological Survey, 2017.
- Lein, J.K., *Environmental Sensing*, Springer, New York, 2012.
- Leopa, S. and Elisei, P., *Methodology on spatial analysis in front-runner and follower cities*, Deliverable No. 2.1, proGIREg. Horizon 2020 Grant Agreement No 776528, European Commission, 2020, 61 pp.
- Leopa, S.; Elisei, P., Knappe, D., Koeneke, H., and Nohra, G.C., *Spatial Analysis in Front-Runner and Follower Cities*, Deliverable No. 2.2, proGIREg. Horizon 2020 Grant Agreement No. 776528, European Commission, 2019.
- Li, T., Guo, S., An, D., and Nametso, M., 'Study on water and salt balance of plateau salt marsh wetland based on time-space watershed analysis', *Ecological Engineering*, Vol. 138, 2019, pp. 160-170.
- Linden, M. and Sheehy, N., 'Comparison of a Verbal Questionnaire and Map in Eliciting Environmental Perceptions', *Environment and Behavior*, Vol. 36, No 1, 2004, pp. 32–40.
- Litwin, L. and Rossa, M., *Geoinformation Metadata in INSPIRE and SDI: Understanding. Editing. Publishing*, Springer Science and Business Media, 2011.
- Luetlich, R.A., Jr., Westerink, J.J., and Scheffner, N.W., *ADCIRC: An Advanced Three-Dimensional Circulation Model for Shelves, Coasts, and Estuaries, Report 1: Theory and Methodology of ADCIRC-2DDI and ADCIRC-3DL, Dredging Research Program Technical Report DRP-92-6*, U.S. Army Engineers Waterways Experiment Station, Vicksburg, 1992.
- Lukyanenko, R., Parsons, J., and Wiersma, Y.F., 'Emerging problems of data quality in citizen science', *Conservation Biology*, Vol. 30, 2016, pp. 447-449.
- Mahmood, A.A. and Elektorowicz, M., 'A review of discrete element method research on particulate systems', In *IOP Conference Series: Materials Science and Engineering*, Vol. 136, No 1, 2016, p. 012034.
- Maldonado, G. and Greenland, S., 'Estimating causal effects', *International Journal of Epidemiology*, Vol. 31, No 2, 2002, pp. 422–429.
- Marcel, M.R., Stadler, J., Korn, H., Irvine, K., and Bonn, A. (Eds.), *Biodiversity and Health in the Face of Climate Change*, Springer International Publishing, Cham, 2019.
- Mason, D.C., Horritt, M.S., Hunter, N.M., and Bates, P.D., 'Use of fused airborne scanning laser altimetry and digital map data for urban flood modelling', *Hydrological Processes*, Vol. 21, No 11, 2007, pp. 1436-1447.

- Matos, P., Vieira, J., Rocha, B., Branquinho, C., and Pinho, P., 'Modeling the provision of air-quality regulation ecosystem service provided by urban green spaces using lichens as ecological indicators', *Science of The Total Environment*, Vol. 665, 2019, pp. 521-530.
- McDonald, A.G., Bealey, W.J., Fowler, D., Dragosits, U., Skiba, U., Smith, R.I., Donovan, R.G., Brett, H.E., Hewitt, C.N., and Nemitz, E., 'Quantifying the effect of urban tree planting on concentrations and depositions of PM10 in two UK conurbations', *Atmospheric Environment*, Vol. 41, No 38, 2007, pp. 8455-8467.
- McKenzie, T.L., Cohen, D.A., Sehgal, A., Williamson, S., and Golinelli, D., 'System for Observing Play and Recreation in Communities (SOPARC): Reliability and Feasibility Measures', *Journal of Physical Activity and Health*, Vol. 3, Suppl. 1, 2006, pp. S208-S222.
- Mechoso, C.R. and Arakawa, A., 'NUMERICAL MODELS: General Circulation Models', In G.R. North, Pyle, J.A., and Zhang, F. (Eds.), *Encyclopedia of Atmospheric Sciences* (2nd ed.), Academic Press, 2015, pp. 153-160.
- Mohareb, E. and Kennedy, C., 'Gross direct and embodied carbon sinks for urban inventories', *Journal of Industrial Ecology*, Vol. 16, No 3, 2012, pp. 302-316.
- Montgomery, D.C., *Design and analysis of experiments*, John Wiley & Sons, New York, 2008.
- Morales-Torres, A., Escuder-Bueno, I., Andrés-Doménech, I., and Perales-Momparler, S., 'Decision Support Tool for energy-efficient, sustainable and integrated urban stormwater management', *Environmental Modelling and Software*, Vol. 84, 2016, pp. 518-528.
- Nelson, E., Mendoza, G., Regetz, J., Polasky, S., Tallis, H., Cameron, D. R., Chan, K.M.A., Daily, G.C., Goldstein, J., Kareiva, P.M., Lonsdorf, E., Naidoo, R., Ricketts, T.H., and Shaw, M.R., 'Modeling multiple ecosystem services, biodiversity conservation, commodity production, and tradeoffs at landscape scales', *Frontiers in Ecology and the Environment*, Vol. 7, No 1, 2009, pp. 4-11.
- Nelson E.J. and Daily G.C., 'Modelling ecosystem services in terrestrial systems', *F1000 Biology Reports*, Vol. 2, 2010.
- Nieto, A., Roberts, S.P.M., Kemp, J., Rasmont, P., Kuhlmann, M., García Criado, M., Biesmeijer, J.C., Bogusch, P., Dathe, H.H., De la Rúa, P., and De Meulemeester, T., *European Red List of Bees*, Publication Office of the European Union, Luxembourg, 2014.
- Nijhuis, S., Zlatanova, S., Dias, E., van der Hoeven, F., and van der Spek, S. (Eds.), 'Geo-Design Advances in bridging geo-information technology, urban planning and landscape architecture', *Research in Urbanism*, Vol. 4, TU Delft Open, Delft, 2014.
- Nowak, D.J., Hirabayashi, S., Bodine, A., and Greenfield, E., 'Tree and forest effects on air quality and human health in the United States', *Environmental Pollution*, Vol. 193, 2014, pp. 119-129.
- Open Geospatial Consortium (OGC), *OGC Sensor Observation Service Interface Standard (v2.0)*, 2012.
- Open Geospatial Consortium (OGC), *Open Geospatial Consortium*, 2019. Available from <http://www.opengeospatial.org/>. Accessed 2019, July 18.
- Orgiazzi, A., Ballabio, C., Panagos, P., Jones, A., and Fernández-Ugalde, O., 'LUCAS Soil, the largest expandable soil dataset for Europe: a review', *European Journal of Soil Science*, Vol. 69, No 1, 2018, pp. 140-153.
- Pain, H., 'A literature review to evaluate the choice and use of visual methods', *International Journal of Qualitative Methods*, Vol. 11, 2012, pp. 303-319.
- Pastorello, G., Papale, D., Chu, H., Trotta, C., Agarwal, D., Canfora, E., Baldocchi, D., and Torn, M., 'A new data set to keep a sharper eye on land-air exchanges', *Eos, Transactions American Geophysical Union*, Vol. 98, No 8, 2017.
- Pepper, I.L., Brusseau, M.L., and Artiola, J., *Environmental monitoring and characterization*, Elsevier Science & Technology, 2004.
- Pesaresi, M., 'Principles and Applications of the Global Human Settlement Layer', *IGARSS 2018 - 2018 IEEE International Geoscience and Remote Sensing Symposium*, Valencia, 2018, pp. 2047-2050.
- Pocock, M.J.O., Chapman, D.S., Sheppard, L.J., and Roy, H.E., *A Strategic Framework to Support the Implementation of Citizen Science for Environmental Monitoring, Final report to SEPA*, Centre for Ecology and Hydrology, Wallingford, 2014.
- Pollard, E. and Yates, T.J., *Monitoring butterflies for ecology and conservation*, Chapman & Hall, New York, 1993.
- Ponto, J., 'Understanding and Evaluating Survey Research', *Journal of The Advanced Practitioner in Oncology*, Vol. 6, No 2, 2015, pp. 168-171.
- Pregolato, M., Ford, A., Robson, C., Glenis, V., Barr, S., and Dawson, R., 'Assessing urban strategies for reducing the impacts of extreme weather on infrastructure networks', *Royal Society Open Science*, Vol. 3, No 5, 2016.

- Raymond, C.M., Pam, B., Breil, M., Nita, M.R., Kabisch, N., de Bel, M., Enzi, V., Frantzeskaki, N., Geneletti, D., Cardinaletti, M., Lovinger, L., Basnou, C., Monteiro, A., Robrecht, H., Sgrigna, G., Munari, L., and Calfapietra, C., *An Impact Evaluation Framework to Support Planning and Evaluation of Nature-based Solutions Projects. Report prepared by the EKLIPSE Expert Working Group on Nature-based Solutions to Promote Climate Resilience in Urban Areas*, Centre for Ecology and Hydrology, Wallingford, 2017.
- Reyers, B., Stafford-Smith, M., Erbs, K.-H., Scholes, R.J., and Selomane, O., 'Essential Variables help to focus Sustainable Development Goals monitoring', *Current Opinion in Environmental Sustainability*, Vol. 26, 2017, pp. 97–105.
- Rosenbaum, P.R., *Design of observational studies*, Springer, New York, 2010.
- Rossman, L.A., *Storm Water Management Model User's Manual Version 5.1*, United States Environmental Protection Agency, Cincinnati, 2015.
- Sahukhal R. and Bajracharya T.R., 'Modeling water resources under competing demands for sustainable development: A case study of Kaligandaki Gorge Hydropower Project in Nepal', *Water Science and Engineering*, Vol. 12, No 1, 2019, pp. 19-26.
- Sang, N. (Ed.), *Modelling Nature-Based Solutions: Integrating Computational and Participatory Scenario Modelling for Environmental Management and Planning*, Cambridge University Press, Cambridge, 2020.
- Schebella, M. F., Weber, D., Schultz, L., and Weinstein, P., 'The Nature of Reality: Human Stress Recovery during Exposure to Biodiverse, Multisensory Virtual Environments', *International Journal of Environmental Research and Public Health*, Vol. 17, No 1, 2020, p. 56.
- Schiavina, M., Melchiorri, M., Corbane, C., Florczyk, A.J., Freire, S., Pesaresi, M., and Kemper, T., 'Multi-Scale Estimation of Land Use Efficiency (SDG 11.3.1) across 25 Years Using Global Open and Free Data', *Sustainability*, Vol. 11, No 20, 2019, p.5674.
- Scholes, R.J., Reyers, B., Biggs, R., Spierenburg, M.J., and Duriappah, A., 'Multi-scale and cross-scale assessments of social-ecological systems and their ecosystem services', *Current Opinion in Environmental Sustainability*, Vol. 5, No 1, 2013, pp. 16-25.
- Schwarz, N., Kahlenberg, D., Haase, D., and Seppelt, R., 'ABMland - A tool for collaborative agent-based model development on urban land use change', *Journal of Artificial Societies and Social Simulation*, Vol. 15, No 2, 2012, p. 8.
- Sekulova, F., Anguelovski, I., Argüelles, L., and Conill, J., 'A 'fertile soil' for sustainability-related community initiatives: A new analytical framework', *Environment and Planning A*, Vol. 49, No 10, 2017, pp. 2362–2382.
- Serrano Sanz, F., Holocher-Ertl, T., Kieslinger, B., Sanz Garcia, F., and Silva, C.G., *White Paper on citizen science for Europe*, 2014. Available from https://ec.europa.eu/futurium/en/system/files/ged/socientize_white_paper_on_citizen_science.pdf
- Seyfang, G. and Longhurst, N., 'What influences the diffusion of grassroots innovations for sustainability? Investigating community currency niches', *Technology Analysis and Strategic Management*, Vol. 28, No 1, 2016, pp. 1–23.
- Simon, H., Fallmann, J., Kropp, T., Tost, H., and Bruse, M., 'Urban Trees and Their Impact on Local Ozone Concentration — A Microclimate Modeling Study', *Atmosphere*, Vol. 10, No 3, 2019, p. 154.
- Smith, K.R. and Roebber, P.J., 'Green roof mitigation potential for a proxy future climate scenario in Chicago, Illinois', *Journal of Applied Meteorology and Climatology*, Vol. 50, No 3, 2011, pp. 507-522.
- Stark, J., Plancke, Y., Ides, S., Meire, P., and Temmerman, S., 'Coastal flood protection by a combined nature-based and engineering approach: Modeling the effects of marsh geometry and surrounding dikes', *Estuarine, Coastal and Shelf Science*, Vol. 175, 2016, pp. 34-45.
- Steinitz, C., 'Beginnings of Geodesign: a personal historical perspective', *Research in Urbanism Series*, Vol. 4, 2016, pp. 9-22.
- Sullivan, L.M., Weinberg, J., and Keaney Jr., J.F., 'Common statistical pitfalls in basic science research', *Journal of the American Heart Association*, Vol. 5, No 10, 2016, p. e004142.
- Sun, C.Y., Lee, K.P., Lin, T.P., and Lee, S.H., 'Vegetation as a Material of Roof and City to cool down the temperature', *Advanced Materials Research*, Vol. 461, 2012, pp. 552-556.
- Sun, L., Wang, W., Gao, F., Cao, C., and Tang, J., 'Distribution and Influencing Factors of Plankton in an Artificial Lagoon in Ningbo', *Asian Journal of Ecotoxicology*, Vol. 4, 2018, pp. 60-67
- Surussavadee, C., 'Evaluation of WRF near-surface wind simulations in tropics employing different planetary boundary layer schemes', In *8th International Renewable Energy Congress (IREC)*, Amman, 2017, pp. 1-4.

- ten Brink, P., Mutafoğlu, K., Schweitzer, J.P., Kettunen, M., Twigger-Ross, C., Baker, J., Kuipers, Y., Emonts, M., Tyrväinen, L., Hujala, T., and Ojala, A., *The health and social benefits of nature and biodiversity protection*, Institute for European Environmental Policy, London/Brussels, 2016.
- Thompson, J.R., Iravani, H., Clilverd, H.M., Sayer, C.D., Heppell, C.M., and Axmacher, J.C., 'Simulation of the hydrological impacts of climate change on a restored floodplain', *Hydrological Sciences Journal*, Vol. 62, 2017, pp. 2482-2510.
- Underwood, E., Darwin, G., and Gerritsen, E., *Pollinator initiatives in EU Member States: Success factors and gaps. Report for European Commission under contract for provision of technical support related to Target 2 of the EU Biodiversity Strategy to 2020 – maintaining and restoring ecosystems and their services*, Institute for European Environmental Policy, Brussels, 2017.
- Vercelloni, J., Clifford, S., Caley, M.J., Pearse, A.R., Brown, R., James, A., Christensen, B., Bednarz, T., Anthony, K., González-Rivero, M., and Mengersen, K., 'Using virtual reality to estimate aesthetic values of coral reefs', *Royal Society Open Science*, Vol. 5, No 4, 2018, p.172226.
- Vranic, S., Kalas, M. Leo, L.S., Bertini, F., Sabbatini, T., Neupane, B., Debele, E., and Barisani F., *GeoIKP Deployment and Maintenance Report, Deliverable No. 7.9, OPERANDUM*, Horizon 2020, Grant Agreement No. 776848, European Commission, 2019.
- Vuik, V., Jonkman, S.N., Borsje, B.W., and Suzuki, T., 'Nature-based flood protection: The efficiency of vegetated foreshores for reducing wave loads on coastal dikes', *Coastal engineering*, Vol. 116, 2016, pp. 42-56.
- Wamsley, T.V., Cialone, M.A., Smith, J.M., Atkinson, J.H., and Rosati, J.D., 'The potential of wetlands in reducing storm surge', *Ocean Engineering*, Vol. 37, 2010, pp. 59-68.
- Weathers, K.C., Hanson, P.C., Arzberger, P., Brentrup, J., Brookes, J., Carey, C.C., Gaiser, E., Hamilton, D.P., Hong, G.S., Ibelings, B., and Istvánovics, V., 'The global lake ecological observatory network (GLEON): The evolution of grassroots network science', *Limnology and Oceanography Bulletin*, Vol. 22, No 3, 2013, pp.71-73.
- World Health Organization (WHO), *Urban Green Space and Health: Intervention Impacts and Effectiveness. Meeting report. Bonn, Germany, 20-21 September 2016*, WHO Regional Office for Europe, Copenhagen, 2017.
- Wilkinson, M.D., Dumontier, M., Aalbersberg, I.J., Appleton, G., Axton, M., Baak, A., Blomberg, N., Boiten, J.W., da Silva Santos, L.B., Bourne, P.E., and Bouwman, J., 'The FAIR Guiding Principles for scientific data management and stewardship', *Scientific Data*, Vol. 3, No 1, 2016, pp. 1-9.
- Williams, A., *Therapeutic Landscapes*, Routledge, London, 2017.
- Wolfram, M., 'Cities shaping grassroots niches for sustainability transitions: Conceptual reflections and an exploratory case study', *Journal of Cleaner Production*, Vol. 173, 2018, pp. 11-23.
- Wood, C.J., Pretty, J., and Griffin, M., 'A case-control study of the health and well-being benefits of allotment gardening', *Journal of Public Health*, Vol. 38, 2016, pp. e336-e344.
- World Bank, *Implementing nature-based flood protection: Principles and implementation guidance*, World Bank, Washington, DC, 2017.
- World Meteorological Organization (WMO), *Essential Climate Variables*, 2020. Available from <https://public.wmo.int/en/programmes/global-climate-observing-system/essential-climate-variables>.
- Woroniecki, S., 'Enabling Environments? Examining Social Co-Benefits of Ecosystem-Based Adaptation to Climate Change in Sri Lanka', *Sustainability*, Vol. 11, No 3, 2019, p. 772.
- Yuan, Z. Y., Jiao, F., Shi, X. R., Sardans, J., Maestre, F. T., Delgado-Baquerizo, M., Reich, P. B., and Peñuelas, J., 'Experimental and observational studies find contrasting responses of soil nutrients to climate change', *eLife*, Vol. 6, 2017, e23255.
- Zulian, G., Polce, C., and Maes, J., 'ESTIMAP: a GIS-based model to map ecosystem services in the European union', *Annali di Botanica*, Vol. 4, 2014, pp. 1-7.

Getting in touch with the EU

IN PERSON

All over the European Union there are hundreds of Europe Direct information centres. You can find the address of the centre nearest you at:

https://europa.eu/european-union/contact_en

ON THE PHONE OR BY EMAIL

Europe Direct is a service that answers your questions about the European Union. You can contact this service:

- by freephone: **00 800 6 7 8 9 10 11** (certain operators may charge for these calls),
- at the following standard number: **+32 22999696**, or
- by email via: https://europa.eu/european-union/contact_en

Finding information about the EU

ONLINE

Information about the European Union in all the official languages of the EU is available on the Europa website at: https://europa.eu/european-union/index_en

EU PUBLICATIONS

You can download or order free and priced EU publications from:

<https://op.europa.eu/en/publications>. Multiple copies of free publications may be obtained by contacting Europe Direct or your local information centre (see https://europa.eu/european-union/contact_en)

EU LAW AND RELATED DOCUMENTS

For access to legal information from the EU, including all EU law since 1952 in all the official language versions, go to EUR-Lex at: <http://eur-lex.europa.eu>

OPEN DATA FROM THE EU

The EU Open Data Portal (<http://data.europa.eu/euodp/en>) provides access to datasets from the EU. Data can be downloaded and reused for free, for both commercial and non-commercial purposes.

The Handbook aims to provide decision-makers with a comprehensive NBS impact assessment framework, and a robust set of indicators and methodologies to assess impacts of nature-based solutions across 12 societal challenge areas: Climate Resilience; Water Management; Natural and Climate Hazards; Green Space Management; Biodiversity; Air Quality; Place Regeneration; Knowledge and Social Capacity Building for Sustainable Urban Transformation; Participatory Planning and Governance; Social Justice and Social Cohesion; Health and Well-being; New Economic Opportunities and Green Jobs.

Indicators have been developed collaboratively by representatives of 17 individual EU-funded NBS projects and collaborating institutions such as the EEA and JRC, as part of the European Taskforce for NBS Impact Assessment, with the four-fold objective of: serving as a reference for relevant EU policies and activities; orient urban practitioners in developing robust impact evaluation frameworks for nature-based solutions at different scales; expand upon the pioneering work of the EKLIPSE framework by providing a comprehensive set of indicators and methodologies; and build the European evidence base regarding NBS impacts. They reflect the state of the art in current scientific research on impacts of nature-based solutions and valid and standardized methods of assessment, as well as the state of play in urban implementation of evaluation frameworks.

Studies and reports

